

PROGRAMMABLE CONTROLLER
FP-XH M8N16PD Control Unit
User's Manual

[Applicable model]

- AFPXHM8N16PD

SAFETY PRECAUTIONS

To prevent accidents or personal injuries, please be sure to comply with the following items. Prior to installation, operation, maintenance and check, please read this manual carefully for proper use. Before using, please fully understand the knowledge related to the equipment, safety precautions and all other precautions.

Safety precautions are divided into two levels in this manual: Warning and Caution.



WARNING Incorrect operation may lead to death or serious injury.

- Take appropriate safety measures to the external circuit of the product to ensure the security of the whole system in case of abnormalities caused by product failure or external.
- Do not use this product in areas with inflammable gases.
Otherwise it may lead to an explosion.
- Do not put this product into a fire.
Otherwise it could cause damage to the battery or other electronic parts.
- Do not impact, charge or heat the lithium battery, and do not put it into a fire.
Otherwise it may lead to fire or damage.



CAUTION Incorrect operation may lead to injury or material loss.

- To prevent the excessive exothermic heat or smoke generation of the product, a certain margin is required for guaranteed characteristics and performance ratings of relative products.
- Do not decompose or transform it.
Otherwise it will lead to the excessive exothermic heat or smoke generation of the product.
- Do not touch terminal blocks during power-on.
Otherwise it may result in an electric shock.
- Set an emergency stop and interlock circuit in the external devices.
- Connect wires and connectors reliably.
Otherwise it may lead to the excessive exothermic heat or smoke generation of the product.
- Ground the protective earth (PE) terminal with Class D grounding (grounding resistance at 100Ω or below).
Otherwise it may result in an electric shock.
- There shall be no foreign matters such as liquids, flammable materials and metals inside the product.
Otherwise it will lead to the excessive exothermic heat or smoke generation of the product.
- Do not carry out construction (wiring, removal, etc.) during power-on.
Otherwise it may result in an electric shock.

Description on Copyright and Trademarks

- The copyright of this manual is owned by Panasonic Industrial Devices SUNX Co., Ltd.
- Unauthorized reproduction of this manual is strictly prohibited.
- Windows is a registered trademark of Microsoft Corporation in the U.S. and other countries.
- Ethernet is a registered trademark of Fuji Xerox Co., Ltd. and Xerox Corporation.
- Other company and product names are trademarks or registered trademarks of their respective companies.

Introduction

Thank you for buying a Panasonic product. Before you use the product, please carefully read the installation instructions and the user's manual, and understand their contents in detail to use the product properly.

Type of Manual

There are different types of users manual for the FP-XH M8N16PD series, as listed below. Please refer to a relevant manual for the unit and purpose of your use.

The manuals can be downloaded on our website:

http://industrial.panasonic.com/ac/e/dl_center/manual/

Unit name or purpose of use	Manual name	Manual code
FP-XH M8N16PD Control Unit	FP-XH M8N16PD Control Unit User's Manual	WUME-FPXHM8N16PD
	FP Series Instruction Manual	ARCT1F313E
Communication Function	FP-XH User Manual (Communication Section)	WUME-FPXHCOM
FP-X Expansion (Communication) Cassette		
FP-X Expansion Unit	FP-X Series User Manual	ARCT1F409E
FP-X Function Cassette		

Control Unit Version

The version of the control unit can be confirmed according to the nameplate on the side of the product body or on the menu of the tool software.

■ Marking of the product body

2 CPU versions are marked on the nameplate on the side of the product body.

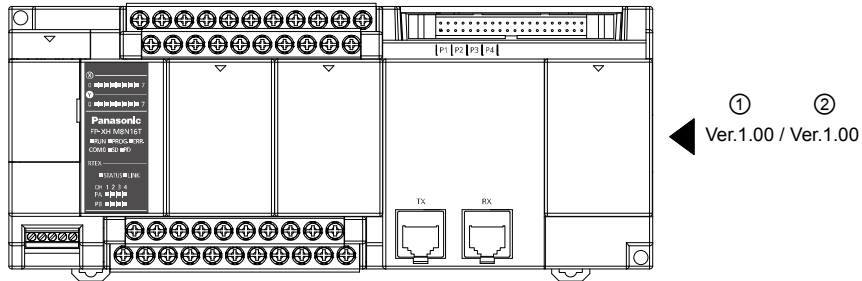

	Description
①	The "Main CPU" version for overall operation is marked.
②	The "Motion CPU" version for motion control is marked.

■ Confirmation based on the tool software

The version of the Main CPU can be confirmed according to Status Display of FPCWIN GR7.

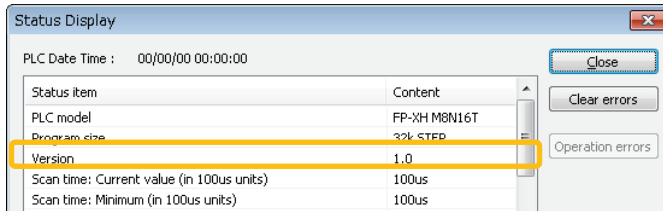

The version of Motion CPU can be confirmed via the Status Display dialog box of Configurator PM7. The dialog box displays the "firmware version".

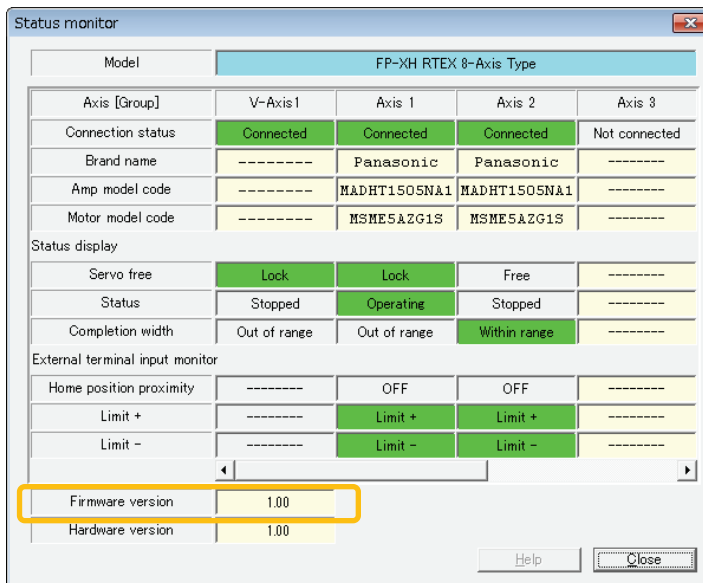

Glossary

As for the following terms, similar expressions are used in the software, manuals and specifications concerning FP-XH M8N Control Unit and Servo Amplifier A6N/A5N.

FP-XH M8N Control Unit	A6N/A5N	Description
-	General-purpose monitor input	Five inputs of symbols SI-MON1 to SI-MON5 are allocated on the A6N/A5N side. By default, the general-purpose monitor input (mark: SI-MON1) is allocated to the terminal on the servo amplifier side. To read the general-purpose input (mark: SI-MON2), it is necessary to change the parameter on the servo amplifier side.
RTEX general-purpose input	-	Up to two points (marks: SI-MON1 to SI-MON2) of the general-purpose monitor inputs on the A6N/A5N side can be read on the FP-XH M8N control Unit side. They are allocated to the I/O input area (WX125).
-	RTEX operation output	On the A6N/A5N side, two outputs of marks EX-OUT1 and EX-OUT2 are allocated. By default, the RTEX operation output (mark: EX-OUT1) is allocated to the terminal on the servo amplifier side. To use the RTEX operation output (mark: EX-OUT2), it is necessary to change the parameter on the servo amplifier side.
RTEX general-purpose output	-	On the FP-XH M8N Control Unit, the two "RTEX operation outputs" connected to the A6N/A5N can be controlled with user programs. The FP-XH M8N Control Unit side is allocated to the I/O output area (WY125).
General-purpose output part	-	It indicates the 8-point DC input circuits and 8-point transistor output circuits connected to the terminal block of the FP-XH M8N Control Unit.
Motion control part	-	It indicates the parts relating to the motor control, interface for the RTEX network and pulse input interface in the FP-XH M8N Control Unit.
Axis number	Node number	The axis numbers controlled by the FP-XH M8N Control Unit match the node numbers of the servo amplifier connected to the RTEX network.

Table of Contents

1. System Structure	1-1
1.1 Overview of System	1-2
1.1.1 Functions of Control Unit.....	1-2
1.1.2 Outline of Specifications.....	1-3
1.2 Unit List.....	1-4
1.2.1 FP-XH M8N Control Unit.....	1-4
1.2.2 FP-X Expansion Unit.....	1-4
1.2.3 FP-X Expansion FP0 Adapter	1-5
1.2.4 FP-X Add-on Cassette (Communication Cassette)	1-5
1.2.5 FP-X Add-on Cassette (Function Cassette).....	1-5
1.3 Unit Type and Product Number.....	1-6
1.3.1 FP-XH M8N16PD Control Unit.....	1-6
1.3.2 FP-X Expansion Unit.....	1-6
1.3.3 FP-X Expansion FP0 Adapter	1-7
1.3.4 FP-X Add-on Cassette (Communication Cassette)	1-7
1.3.5 FP-X Add-on Cassette (Function Cassette).....	1-7
1.3.6 Options	1-7
1.3.7 Repair Parts	1-8
1.4 Restrictions on Unit Combinations	1-9
1.4.1 Restrictions on FP-X Expansion Units	1-9
1.4.2 Restrictions on FP-X Expansion Adapter.....	1-11
1.4.3 Restrictions on Add-on cassette Combination	1-12
1.4.4 Restrictions on Communication Function	1-14
1.5 Restrictions on Servo Amplifier	1-15
1.5.1 Restrictions on Parameter Settings.....	1-15
1.5.2 Combination of Parameters and Home Return Methods	1-16

2. Control Unit Specifications	2-1
2.1 Parts Name and Funcations	2-2
2.1.1 Control Unit	2-2
2.1.2 Status Indicator LEDs.....	2-4
2.1.3 COM0 Port Specifications	2-5
2.2 Power Supply Specifications	2-6
2.3 Input / Output Specifications (General-purpose input/output part).....	2-7
2.3.1 Input Specifications	2-7
2.3.2 Output Specifications	2-8
2.4 Input Specifications (Pulse Input Part)	2-9
3. I/O Allocation.....	3-1
3.1 Basic I/O Assignment	3-2
3.1.1 Counting Method of I/O Numbers	3-2
3.1.2 I/O Number Assignment Method.....	3-2
3.2 List of I/O Numbers for Units	3-4
3.2.1 FP-XH M8N Control Unit (General-purpose I/O Part).....	3-4
3.2.2 FP-XH M8N Control Unit (Motion Control Part)	3-5
3.2.3 FP-X Expansion Unit.....	3-7
3.2.4 FP-X Function Cassette	3-8
3.3 Assignment of FP0 Expansion Units.....	3-9
3.3.1 I/O Number Assignment Method.....	3-9
3.3.2 Types and I/O Numbers of FP0R Expansion Units.....	3-10
3.3.3 Types and I/O Numbers of FP0 Expansion Units	3-11
3.4 Detailed I/O Information of Motion Control Part	3-12

4. Installation	4-1
4.1 Installation.....	4-2
4.1.1 Installation Environment and Space.....	4-2
4.2 Backup Battery Installation.....	4-4
4.2.1 Backup Battery Installation.....	4-4
4.3 Add-on cassette Installation	4-5
4.3.1 Precautions for Installing Add-on cassettes.....	4-5
4.3.2 Communications Cassette Installation	4-5
4.3.3 Function Cassette Installation	4-6
4.4 Connecting FP-X Expansion Unit	4-7
4.4.1 Setup of Terminal Setting Switches	4-7
4.4.2 Confirmation of FP-X Expansion Cables	4-7
4.4.3 Connecting FP-X expansion unit.....	4-8
4.5 Connecting FP0 Expansion Unit	4-9
4.5.1 Connecting FP0 Expansion Unit	4-9
4.5.2 Connecting FP-X Expansion FP0 Adapter.....	4-10
4.6 Installation.....	4-11
4.6.1 Installation and Removal for DIN Rail	4-11
4.6.2 Mounting with Screws	4-12
5. Wiring of Power Supply and General-purpose I/O Parts .	5-1
5.1 Terminal Arrangement	5-2
5.1.1 Power Supply and General-purpose I/O Parts.....	5-2
5.2 Wiring of Power Supply.....	5-3
5.2.1 General Precautions	5-3
5.2.2 Grounding.....	5-3
5.2.3 Power Supply of Control Unit / Expansion Unit.....	5-4
5.2.4 Power Supply of FP-X Expansion FP0 Adapter / FP0 Expansion Unit...	5-6

- 5.3 Wiring of Input and Output.....5-8
 - 5.3.1 Precautions Regarding Input and Output Wirings.....5-8
 - 5.3.2 Input Wiring5-9
 - 5.3.3 Output Wiring5-11
- 5.4 Wiring of Terminal Block.....5-12
 - 5.4.1 Suitable Wires5-12
 - 5.4.2 Terminal Block Cover.....5-12
 - 5.4.3 Installation and Removal of Terminal Block.....5-13
- 5.5 Safety Measures5-14
 - 5.5.1 Safety Measures5-14
 - 5.5.2 Momentary Power Failures5-15
 - 5.5.3 Watchdog Timer.....5-15

6. Wiring of Motion I/O Parts..... 6-1

- 6.1 Terminal Layout Diagram6-2
- 6.2 Settings on Servo Amplifier6-3
 - 6.2.1 Checking Rotary Switches6-3
 - 6.2.2 Connection of Limit Input and Near Home Input.....6-4
 - 6.2.3 Combination of Parameters and Home Return Methods.....6-5
 - 6.2.4 Connection of General-purpose Monitor Input.....6-6
 - 6.2.5 Connection of RTEX Operation Output.....6-6
- 6.3 Connection of Network6-7
 - 6.3.1 Wiring Method6-7
 - 6.3.2 Precautions on Wiring6-7
- 6.4 Pulse Input Connection6-8
 - 6.4.1 Linear Driver Type.....6-8
 - 6.4.2 Transistor Open-collector Type.....6-8
 - 6.4.3 Transistor Resistor Pulling Up Type.....6-8
 - 6.4.4 Precautions on Wiring6-10
 - 6.4.5 Specifications of Scattered Cable Connectors.....6-10
 - 6.4.6 Usage of Scattered Cable Connector6-11

7. Power On/Off and Check Items	7-1
7.1 Before Turning On the Power.....	7-2
7.2 Procedure for Turning On the Power.....	7-3
7.2.1 Procedure for Turning On the Power	7-3
7.2.2 Procedure for Turning Off the Power	7-3
7.3 Check with Power Turned On	7-4
7.3.1 Check items after turning power on	7-4
7.3.2 Checking the network communication state	7-5
7.3.3 Checking the safety circuit based on a unit	7-6
7.3.4 Checking the operation of near home switch.....	7-7
7.3.5 Checking the rotation, movement direction and distance	7-7
8. Steps Before Running.....	8-1
8.1 Before Turning on the Power	8-2
8.1.1 Check Items	8-2
8.1.2 Steps Before Running	8-3
8.2 Offline Editing of the Program	8-4
8.2.1 Program Elements.....	8-4
8.2.2 Settings of the System Register.....	8-4
8.2.3 Setting of Position Control Parameters	8-5
8.3 Program Download and Run	8-6
8.3.1 Before Turning on the Power	8-6
8.3.2 Program Downloading and Mode Switching	8-7
8.3.3 Overall Program Check.....	8-11
8.3.4 Program Verify	8-11
8.4 Online Editing	8-13
8.4.1 Online Editing Summary	8-13
8.4.2 Online Editing of the Program	8-13
8.4.3 Online Editing of the System Register	8-15

8.5	Program block	8-16
8.5.1	Program block summary	8-16
8.5.2	Change Sequence of PBs	8-17
9.	Setting of Position Control Parameters	9-1
9.1	Axis Allocation for Use.....	9-2
9.1.1	Settings in Configurator PM7	9-2
9.2	Parameter settings	9-4
9.2.1	Parameter Settings in Configurator PM7	9-4
9.2.2	Parameter setting items	9-5
9.3	Synchronous Parameter / Cam Pattern Settings	9-8
9.3.1	Synchronization parameter settings.....	9-8
9.3.2	Cam Pattern Settings	9-9
9.4	Creating Positioning Data Table	9-10
9.4.1	Structure of the position control data table.....	9-10
9.4.2	Select type of position control data setting area	9-11
9.4.3	Data table No. and position control startup	9-12
9.4.4	Running Mode and Data table	9-13
9.5	Saving and Managing Files	9-14
9.5.1	File Type.....	9-14
9.5.2	Saving Parameters as Part of Project File	9-14
9.5.3	Saving Parameters as Parameter File	9-15
9.5.4	Exporting Parameters to CSV Files	9-16
10.	Transfer to Unit and Commissioning.....	10-1
10.1	Check on Settings	10-2
10.1.1	Data Check of Parameters	10-2
10.1.2	Comparison of Parameter information	10-3
10.2	Transfer of parameters	10-4

10.2.1	Download by FPWN GR7	10-4
10.2.2	Download by Configurator PM7	10-5
10.3	Monitoring on Configurator PM7	10-6
10.3.1	Status Monitor	10-6
10.3.2	Data Monitor	10-8
10.4	Tool Operation	10-10
10.4.1	Tool Operation Function	10-10
10.4.2	Servo ON/OFF with Tool Operation Function	10-11
10.4.3	JOG Operation with Tool Operation Function	10-12
10.4.4	Home Return by Tool Operation Function	10-14
10.4.5	Positioning by Tool Operation Function	10-16
10.4.6	Teaching by Tool Operation Function	10-19
10.5	Monitoring Current Value with Program	10-21
10.5.1	Current Value Area	10-21
10.5.2	Reading of the current value	10-21
11.	Automatic Operation (Position Control)	11-1
11.1	Basic Operations	11-2
11.1.1	Position Control Method	11-2
11.1.2	Setting and Operation of E-point Control	11-4
11.1.3	Setting and Operation of P-point Control	11-5
11.1.4	Setting and Operation of C-point Control	11-6
11.1.5	Setting and Operation of J-point Control	11-7
11.1.6	Sample Program (E-point, P-point and C-point Control)	11-9
11.1.7	Sample Program (J-point Control)	11-10
11.1.8	Programming Precautions	11-11
11.2	Interpolation Control	11-12
11.2.1	Interpolation Control Types	11-12
11.2.2	Setting and Operation of 2-axis Linear Interpolation	11-15
11.2.3	Setting and Operation of 2-axis Circular Interpolation	11-17
11.2.4	Setting and Operation of 3-axis Linear Interpolation	11-19

11.2.5	Setting and Operation of 3-axis Spiral Interpolation	11-21
11.2.6	Sample Program (Interpolation Control)	11-23
11.3	Positioning Repeat Function	11-24
11.3.1	Setting and Operation of Repeat Operation.....	11-27

12. Automatic Operation (Synchronous Control) 12-1

12.1	Synchronous Control	12-2
12.1.1	Outline of Synchronous Control	12-2
12.2	Settings for Master and Slave Axes	12-4
12.2.1	Selection for Master and Slave Axes	12-4
12.2.2	Selection of Slave Axes and Settings	12-5
12.3	Start and Cancel of Synchronous Control	12-6
12.3.1	Start and Cancel of Synchronous Control.....	12-6
12.3.2	Precautions When Canceling or Starting Synchronous Control	12-8
12.4	Electronic Gear Function	12-12
12.4.1	Outline of Electronic Gear Function	12-12
12.4.2	Types and Contents of Setting Parameters	12-13
12.4.3	Gear Ratio Changes while in Operation.....	12-14
12.5	Electronic Clutch Function	12-16
12.5.1	Electronic Clutch Function.....	12-16
12.5.2	Types and Contents of Setting Parameters	12-17
12.5.3	Trigger Types for Electronic Clutch.....	12-18
12.5.4	Engagement Methods of Electronic Clutch	12-19
12.5.5	Phase Specification Clutch Off Function.....	12-20
12.6	Electronic Cam Function.....	12-22
12.6.1	Outline of Electronic Cam Function.....	12-22
12.6.2	Types and Contents of Setting Parameters	12-24
12.6.3	Cam Pattern Setting Method	12-25
12.6.4	Rewriting Cam Patterns by Programs.....	12-32
12.6.5	Advance Angle Correction Function.....	12-39

13. Manual Operation (JOG Operation).....	13-1
13.1 Setting and Operation of JOG Operation.....	13-2
13.2 Speed Change During Operation	13-4
14. Manual Operation (Home Return).....	14-1
14.1 Type of Home Return.....	14-2
14.2 Setting and Operation of Home Return	14-6
15. Pulse Input Function	15-1
15.1 Pulse Input.....	15-2
15.1.1 Pulse input application	15-2
15.1.2 Selection of Pulse Input Applications	15-3
15.1.3 Input mode of pulse input.....	15-4
15.1.4 Monitoring of Pulse Input Values	15-6
15.1.5 Pulse Input Value Change Function.....	15-6
15.2 Setting and Operation of Pulsar	15-8
15.2.1 Overview	15-8
15.2.2 Settings for Pulsar Operation	15-9
15.2.3 Operation of Pulsar	15-10
15.3 Pulse Input / High-speed Counter Function.....	15-12
15.3.1 Overview	15-12
15.3.2 Settings When Using High-speed Counter	15-12
15.3.3 Count Disable/Enable Control	15-13
16. Stop Function	16-1
16.1 Types and Settings of Stop Function.....	16-2
16.1.1 Type of Stop Operations	16-2

16.1.2 Stop Time Settings.....	16-3
16.2 Operation During Stop.....	16-4
16.3 Pause Function	16-5
16.3.1 Pause Function	16-5
16.3.2 Pause Settings	16-5
17. Auxiliary Function.....	17-1
17.1 Dwell Time.....	17-2
17.2 Software Limit.....	17-3
17.3 Auxiliary Output.....	17-4
17.3.1 Auxiliary Output Function	17-4
17.3.2 Auxiliary Output Settings	17-5
17.3.3 Monitoring of Auxiliary Output.....	17-6
17.3.4 Operation upon Movement Change during Operation	17-6
17.4 Coordinate Origin	17-7
17.5 Current Value Update.....	17-9
17.6 Target Speed Change Function.....	17-11
17.6.1 Overview.....	17-11
17.6.2 Setting Procedures and Operations (Speed Direct Specification Method).....	17-12
17.6.3 Setting Procedures and Operations (Ratio Specification Method).....	17-15
17.7 Movement Amount Change Function.....	17-17
17.7.1 Overview.....	17-17
17.7.2 Setting Procedures and Operations	17-18
17.8 Direct Input / Output	17-22
17.8.1 Direct Input / Output Function	17-22
17.8.2 Direct Input	17-24
17.8.3 Direct Output	17-25
17.9 Torque Limit	17-26

17.10	Monitor Error (Torque / Actual Speed Judgement)	17-29
17.11	Operation Done Signal	17-30
17.11.1	Operation Done Flag and Imposition Flag	17-30
17.12	Position Deviation Simple Monitor	17-31
17.13	AMP Parameter R/W Function	17-32
17.13.1	Overview	17-32
17.13.2	Reading Parameters from AMP	17-33
17.13.3	Writing Parameters to AMP	17-35
17.13.4	Saving AMP Parameters (Writing to EEPROM)	17-37
17.13.5	Resetting AMP (Restart)	17-39
17.14	AMP Monitoring Function	17-41
17.14.1	Overview	17-41
17.14.2	Monitoring Items	17-41
17.14.3	Monitoring Procedure	17-43
18.	Instruction Reference	18-1
18.1	Motion Control Instructions	18-2
18.1.1	[F384 PTBLR] Positioning parameter read instruction	18-2
18.1.2	[F385 PTBLW] Positioning parameter write instruction	18-3
18.1.3	[F386 PSET] Positioning start data table setting	18-4
18.1.4	[F387 PSTRD] Axis status acquisition	18-5
18.1.5	[F388 PERRD] Positioning error /warning acquisition	18-7
18.1.6	[F389 UCLR] Positioning error / warning clearing	18-8
18.2	Direct Input Instruction	18-9
18.2.1	[DST·DST/] Direct start / Direct start NOT	18-9
18.2.2	[DAN·DAN/] Direct AND /Direct AND NOT	18-12
18.2.3	[DOR·DOR/] Direct OR / Direct OR NOT	18-15
18.3	Direct Output Instruction	18-18
18.3.1	[DOT] Direct output	18-18
18.3.2	[DSET·DRST] Direct set / Direct reset	18-21

18.3.3 [DKP] Direct hold..... 18-26

19. Error/Warning Annunciation Function 19-1

19.1 Errors and Warnings..... 19-2

 19.1.1 Errors and Warnings 19-2

 19.1.2 Check and Clearing with Configurator PM7 19-2

 19.1.3 Check and Clearing with User Program..... 19-3

 19.1.4 Error/Warning Log 19-4

19.2 Change of Error Recovery Processing..... 19-6

 19.2.1 Outline 19-6

19.3 Table of Error Codes 19-7

 19.3.1 AMP Errors (0001H 0-)..... 19-7

 19.3.2 System Errors (1000H -) 19-14

 19.3.3 AMP Communication Errors (2000H -) 19-15

 19.3.4 Axis Operation Errors (3000H -)..... 19-16

 19.3.5 Set Value Errors (4000H -)..... 19-18

 19.3.6 Setting value errors of synchronous parameters (5000H -)..... 19-22

19.4 Table of Warning Codes 19-25

 19.4.1 AMP Warnings (A000H -)..... 19-25

 19.4.2 Unit Warning (B000H -)..... 19-26

20. Troubleshooting..... 20-1

20.1 Self-diagnosis Function 20-2

 20.1.1 Status display LED of the Control Unit..... 20-2

 20.1.2 Status Display LED of the FP-X Expansion FP0 Adapter..... 20-3

 20.1.3 Operation mode in case of exception..... 20-3

20.2 What to Do If an Error Occurs..... 20-4

 20.2.1 ERR LED Blinking 20-4

 20.2.2 When Not Switched to RUN Mode..... 20-6

 20.2.3 When ERR.LED Lights Up 20-6

20.2.4	If All LEDs are Not Lit.....	20-7
20.2.5	When Protection Error Message Shows	20-7
20.2.6	When the Output is Not Normal	20-8
20.2.7	When Expansion Units are Not Operated	20-9
20.2.8	In Case of Communication Error (RS-232C)	20-10
20.2.9	In Case of Communication Error (RS-422)	20-11
20.2.10	In Case of Communication Error (RS-484)	20-12
20.2.11	In Case of Communication Error (Ethernet).....	20-13
20.3	What to Do If an Error Occurs	20-14
20.3.1	Cannot Communicate with AMP	20-14
20.3.2	Motor does Not Rotate and Operate	20-15
21.	Memory /Master Memory Cassette.....	21-1
21.1	Memory Backup	21-2
21.1.1	Program Memory Backup	21-2
21.1.2	Operation Memory Backup	21-2
21.1.3	Operation Memory Backup (When Battery Installed).....	21-3
21.1.4	Alarm Battery Error / Setting of the Hold area	21-4
21.2	RAM / ROM Transfer Function.....	21-6
21.2.1	Outline of function	21-6
21.2.2	Operations Using Tool Software	21-6
21.3	Functions of Master Memory Cassette	21-7
21.3.1	Outline of Functions	21-7
21.3.2	Setting of Master Memory Unit.....	21-7
21.4	Master Memory Function	21-8
21.4.1	Outline of Function	21-8
21.4.2	Before Turning on the Power	21-9
21.4.3	Transferring Data to Master Memory Cassette	21-10
21.4.4	Transferring Data from Master Memory Cassette to Control Unit	21-12
21.4.5	Using Master Memory Cassette with Other Models.....	21-13
21.5	Clock/Calendar	21-14

21.5.1 Outline of Function	21-14
21.5.2 Clock/calendar Setting	21-14
21.5.3 Clock/calendar Application Examples	21-15

22. Security Functions..... 22-1

22.1 Password Protection Function	22-2
22.1.1 Outline of Function	22-2
22.1.2 Tool software setting	22-2
22.2 Program Upload Protection Function	22-9
22.2.1 Outline of Function	22-9
22.2.2 Tool Software Setting	22-10
22.3 Security Function Applicability List.....	22-11
22.3.1 Control Unit	22-11

23. General-purpose Input / High-speed counter Function 23-1

23.1 General-purpose Input / High-speed counter Function Summary	23-2
23.1.1 High-speed counter Function Summary.....	23-2
23.1.2 Counting Range and Elapsed Value (Current Value) Area.....	23-2
23.1.3 When using the high-speed counter function.....	23-3
23.1.4 Type of Input Mode	23-4
23.1.5 Minimum Input Pulse Width.....	23-5
23.2 Settings of the System Registers.....	23-6
23.2.1 Settings of System Registers	23-6
23.3 General-purpose Input / High-speed Counter Related Instruction.....	23-8
23.3.1 [F0 MV] High-speed counter control instruction	23-8
23.3.2 [F1 DMV] Elapsed value read and write instruction	23-10
23.3.3 [F166 HC1S] High-speed counter target value consistent ON instruction [F167 HC1R] High-speed counter target value consistent OFF instruction	23-11
23.3.4 Interruption program startup when target value has consistent control	23-13
23.4 Sample Program	23-14

23.4.1	Running of the position control which has used inverter (1 speed)	23-14
23.4.2	Running of the position control which has used inverter (2 speed)	23-16
24.	Other Functions.....	24-1
24.1	Analog Potentiometer.....	24-2
24.1.1	Outline of Function	24-2
24.1.2	Analog Potentiometer Application Examples	24-2
24.2	Input Time Constant Setting Function	24-3
24.2.1	Outline of Function	24-3
25.	Maintenance and Inspection.....	25-1
25.1	Precautions for Using Backup Battery.....	25-2
25.1.1	Backup Battery Replacement.....	25-2
25.1.2	Backup Battery Lifetime and Replacement Time.....	25-3
25.2	Inspection	25-4
26.	Specifications	26-1
26.1	Control Unit Specifications	26-2
26.1.1	General Specifications	26-2
26.1.2	Performance Specifications	26-3
26.1.3	Performance Specifications of Motion Control Part	26-5
26.2	Communication Specifications	26-8
26.2.1	Communication Specifications of Control Unit.....	26-8
26.2.2	Specifications of Communication Cassette.....	26-9
26.3	Operation Memory Areas	26-11
26.4	Positioning Memory	26-12
26.4.1	Entire Configuration of Positioning Memory.....	26-12
26.4.2	Common Area (Memory Area No.0)	26-16

- 26.4.3 Each Axis Information Area (Memory Area No. 1).....26-34
- 26.4.4 Each Axis Setting Area (Memory Area No. 2).....26-36
- 26.4.5 Cam Pattern Editing Area (Memory Area No. 3).....26-50
- 26.4.6 Synchronous Control Area (Memory Area No. 4)26-54
- 26.4.7 Positioning Operation Change Setting Area (Memory Area No. 5)26-57
- 26.4.8 AMP Parameter Control Area (Memory Area No. 6).....26-58

- 26.5 Table of System Registers.....26-59

- 26.6 Table of Special Internal Relays26-65

- 26.7 Table of Special Data Registers26-78

- 26.8 Table of Error Codes26-91
 - 26.8.1 Table of Syntax Check Errors26-91
 - 26.8.2 Table of Self-diagnostic Errors.....26-92
 - 26.8.3 Table of MEWTOCOL-COM Communication Errors26-94

- 26.9 Dimensions.....26-95
 - 26.9.1 Dimensions.....26-95
 - 26.9.2 Installation Dimensions26-95

1

System Structure

1.1 Overview of System

1.1.1 Functions of Control Unit

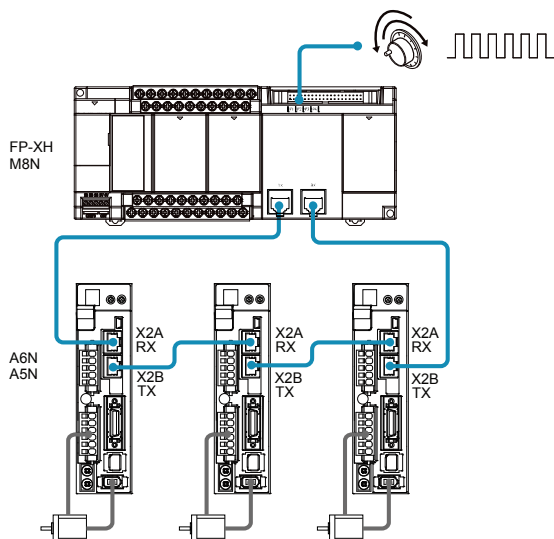

■ Controls the Servo Motor MINAS A6N/A5N series

The FP-XH M8N Control Unit can control servo motors of up to 8 axes via the motion-dedicated network Realtime Express (RTEX). It achieves wiring saving by network connection and high-speed control.

(Note): Realtime Express and RTEX are registered trademarks of Panasonic.

■ Flexibly deals with positioning control up to eight axes

The FP-XH M8N Control Unit supports independent control, interpolation control and synchronous control, and deals with simple control through complicated control.

■ Hybrid controller equipped with general-purpose inputs and outputs

The general-purpose I/O of 8-point inputs and 8-point outputs and RS-232C port are equipped as the standard equipment in addition to the I/F for network servo.

■ Pulse input function usable for high-speed counter and manual pulsar

A maximum of four-channel inputs are available, and can be used for the high-speed counter and pulsar operation.

■ Can use various options of the existing models of FP-X series

Various add-on cassettes and expansion units can be used. The communication interface, digital I/O and analog I/O can be easily expanded.

■ Shortens the startup time by using "Configurator PM7"

By using the setting monitoring software for positioning control "Configurator PM7", positioning parameters and tables can be easily managed. Also, the "Tool operation function" which enables the adjustment without ladder programs shortens the startup time.

1.1.2 Outline of Specifications

The unit supports the independent control, interpolation control and synchronous control, and the maximum of 8 axes can be used within the following ranges.

■ Combination of control axes

Item name	Specifications		
Number of axes controlled	Max. 8 axes		
Independent control	Max. 8 axes		Combination of independent, interpolation and synchronous controls: Max. 8 axes
Interpolation Control	2-axis linear interpolation, 2-axis circular interpolation, 3-axis linear interpolation, 3-axis spiral interpolation: max. 8 axes		
Synchronous control	Master axis (real axis): Max. 4 axes	Combination of real and virtual axes: Max. 4 axes	
	Master axis (virtual axis): Max. 2 axes		
	Slave axis: Max. 8 axes		

(Note 1): The pulse input can be used as the input of the synchronous control master axis.

■ Communication specifications of motion control part

Item	Specification
Physical layer	100BASE-TX (IEEE802.3)
Baud rate	100 Mbps
Transmission distance	Between nodes: Max. 100 m, Total length: Max. 200 m
Topology	Ring
Applicable cable	STP cable (category 5e or higher)
Connector	9-pin RJ45 x 2
Communication cycle	0.5 ms
Position command update	1 ms
No. of connected slaves	Max. 8 slaves
Coconnected slave	Panasonic AC Servo Motor A6N series/A5N series

1.2 Unit List

1.2.1 FP-XH M8N Control Unit

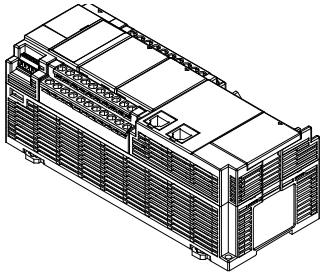

Divided into the following types according to points, power supply and output type.

Points	General I/O part: 16 points, motion control part (RTEX I/F and 4-ch pulse input for 8-axis control)	
Power supply	24 VDC	
Output	General output part: transistor (PNP output)	
	RTEX I/F port for motion control RX45 x 2 ports (RX/TX)	

1.2.2 FP-X Expansion Unit

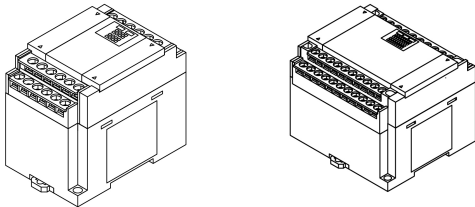

Divided into the following types according to points, power supply and output type. Can be used with the old models FP-X.

■ FP-X Expansion Unit

Points	14 points (for output) / 16 points (for input) / 16 points	30 points
Power supply	No power supply	100-240 VAC or 24 VDC
Output	Relay or transistor (NPN output or PNP output)	

1.2.3 FP-X Expansion FP0 Adapter

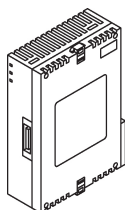

Interface adapters enabling connection with FP0/FP0R series expansion unit / high function unit.

1.2.4 FP-X Add-on Cassette (Communication Cassette)

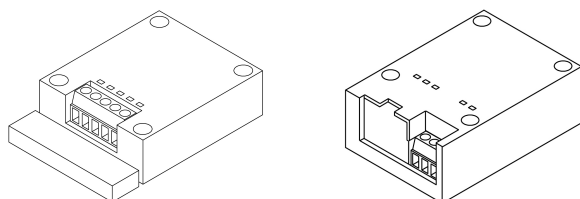

Divided into the following types according to the type of communication interface and the number of channels.

Communication pattern	RS-232C (5-wire) × 1ch
	RS-232C (3-wire) × 2ch
	RS-485 / RS-422 × 1ch
	RS-485 × 1ch + RS-232C (3-wire) × 1ch
	RS-485 × 2ch
	Ethernet × 1ch + RS-232C (3-wire) × 1ch

1.2.5 FP-X Add-on Cassette (Function Cassette)

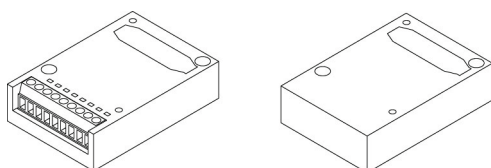

Divided into the following types according to the output type and function.

Analog input and output	Analog input × 2ch Analog output × 2ch Analog input × 2ch + analog output × 1ch
Digital input and output	Input 8 points, transistor output 8 points Input 4 points + transistor output 3 points
Master memory	Master memory + real-time clock

1.3 Unit Type and Product Number

1.3.1 FP-XH M8N16PD Control Unit

Product Name	Specification		Product no.
	Input / Output Specifications	Power supply	
FP-XH M8N16PD Control Unit	DC input 8 points, transistor output 8 points RTEX I/F (for 8 axes) for motion control 4-channel pulse input	24 VDC	AFPXHM8N16PD

1.3.2 FP-X Expansion Unit

Product Name	Specification		Product no.
	Input / Output Specifications	Power supply	
FP-X E16 expansion I/O unit	DC input 8 points, relay output 8 points	-	AFPX-E16R
	DC input 8 points, transistor output (NPN) 8 points	-	AFPX-E16T
	DC input 8 points, transistor output (PNP) 8 points	-	AFPX-E16P
FP-X E30 expansion I/O unit	DC input 16 points, relay output 14 points	100-240 VAC	AFPX-E30R
		24 VDC	AFPX-E30RD
	DC input 16 points, transistor output (NPN) 14 points	100-240 VAC	AFPX-E30T
		24 VDC	AFPX-E30TD
	DC input 16 points, transistor output (PNP) 14 points	100-240 VAC	AFPX-E30P
		24 VDC	AFPX-E30PD
FP-X E16 expansion input unit	DC input 16 points	-	AFPX-E16X
FP-X E14R expansion output unit	Relay output 14 points	-	AFPX-E14YR

(Note) Comes with expansion cables (8 cm type).

1.3.3 FP-X Expansion FP0 Adapter

Name	Specification	Product no.
FP-X Expansion FP0 Adapter	Used to connect with the FP0 expansion unit	AFPX-EFP0

(Note) Comes with expansion cables (8 cm type).

1.3.4 FP-X Add-on Cassette (Communication Cassette)

Name	Specification	Product no.
FP-X communication cassette	RS-232C 5-wire × 1 channel	AFPX-COM1
	RS-232C 3-wire × 2 channel	AFPX-COM2
	RS-485 / RS-422 (insulated) × 1 channel	AFPX-COM3
	RS-485 (insulated) × 1 channel + RS-232C 3-wire × 1 channel	AFPX-COM4
	RS-485 (insulated) × 2 channels (non-insulated between channels)	AFPX-COM6
	Ethernet port + RS-232C 3-wire × 1 channel	AFPX-COM5



1.3.5 FP-X Add-on Cassette (Function Cassette)

Name		Specification	Product no.
Analog input and output	FP-X analog input cassette	Analog input (non-isolated) × 2 channels	AFPX-AD2
	FP-X analog output cassette	Analog output (insulated) × 2 channels (insulated between channels)	AFPX-DA2
	FP-X analog I/O cassette	Analog input (insulated) × 2 channels (non-insulated between channels) + analog output (insulated) × 1 channel	AFPX-A21
	FP-X thermocouple cassette	Thermocouple input (insulated) × 2 channels (insulated between channels)	AFPX-TC2
	FP-X temperature measuring resistor cassette	Temperature measuring resistor input (insulated) × 2 channels (insulated between channels)	AFPX-RTD2
Digit input and output	FP-X input cassette	8-point DC input	AFPX-IN8
	FP-X output cassette	8-point transistor output (NPN)	AFPX-TR8
	FP-X output cassette	6-point transistor output (PNP)	AFPX-TR6P
	FP-X input and output cassette	4-point DC input + 3-point transistor output (NPN)	AFPX-IN4T3
FP-X master memory cassette		Master memory + real-time clock	AFPX-MRTC

1.3.6 Options

Name	Specification	Product no.
FP-XH backup battery	Required when expanding operation memory keeping area and using the clock/calendar function.	AFPXHBATT

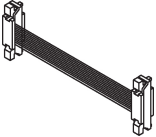
1.3.7 Repair Parts

	Name	Specification	Product no.
	FP-X expansion cable (note)	8cm	AFPX-EC08
		30cm	AFPX-EC30
		80cm	AFPX-EC80
	FP0 power cable	For expansion FP0 adapters, 1 m long	AFP0581

(Note 1): The FP-X expansion unit and high-function unit include 8 cm expansion cables. The total length of the expansion cables should be within 160 cm.

(Note 2): when using long expansion cables, I/O checking error may occur due to noises and other effects. In this case, it is recommended to take measures such as using ferrite cores.

1.4 Restrictions on Unit Combinations

1.4.1 Restrictions on FP-X Expansion Units

■ **Expansion Number and Order Limitations (1)**

- Connect up to 8 expansion units.

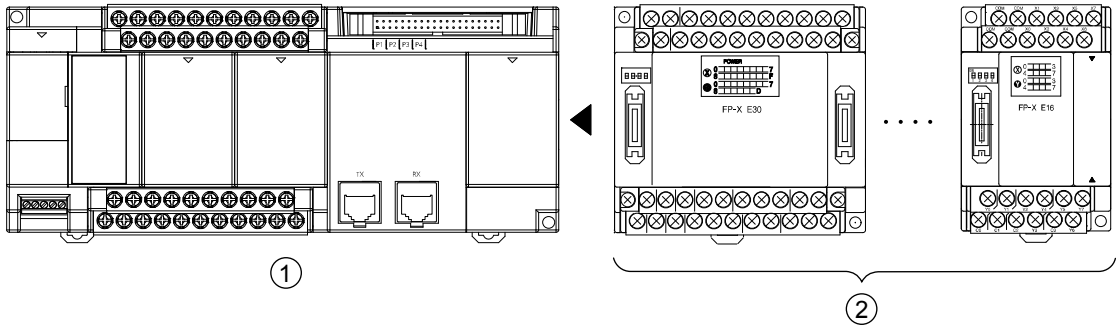

①	FP-XH M8N control unit	②	FP-X Expansion Unit
---	------------------------	---	---------------------

■ **Maximum Control I/O Points**

Type of Control Unit	I/O Points for Single Control Unit	I/O Points for FP-X-E30 Expansion
FP-XH M8N control unit	16 points (note)	Maximum 256 points

(Note) Points mentioned in the table above means the I/O points of the general I/O part.

■ **Expansion Cable Combination Limitations**

- Please limit the total length of the expansion cable to less than 160 cm.

■ Expansion Cable Combination Limitations (2)

- The number of expansion units can be connected and expanded varies with its types.

	Unit Type		Remarks
①	FP-XH M8N control unit		
②	FP-X Expansion I/O Unit	E14YR, E16R	Expansion I/O unit without built-in power supply
		E16X, E16T, E16P Ver.3.0 or below	
③	FP-X Expansion I/O Unit	E16X, E16T, E16P Ver.3.0 or above	Expansion I/O unit without built-in power supply
④	FP-X Expansion I/O Unit	E30	Expansion I/O unit with built-in power supply

- In the FP-X expansion I/O unit, continuously connecting two units in group 2 shown in the above table is not possible. However, it can be expanded on the right side of the expansion I/O unit with built-in power supply.

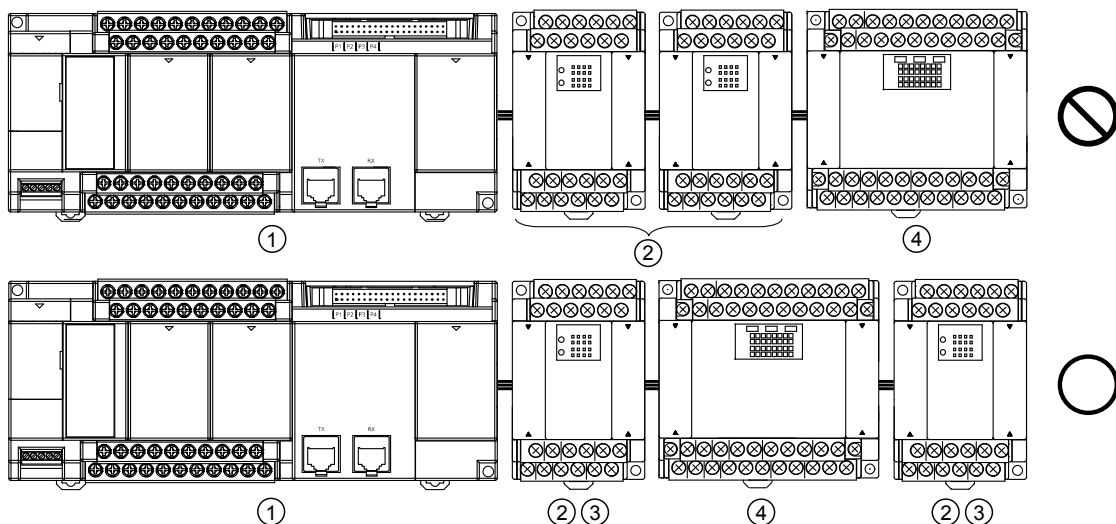

- In the unit without built-in power supply of the FP-X expansion I/O unit, up to three units in group 3 shown in the above table can be connected.

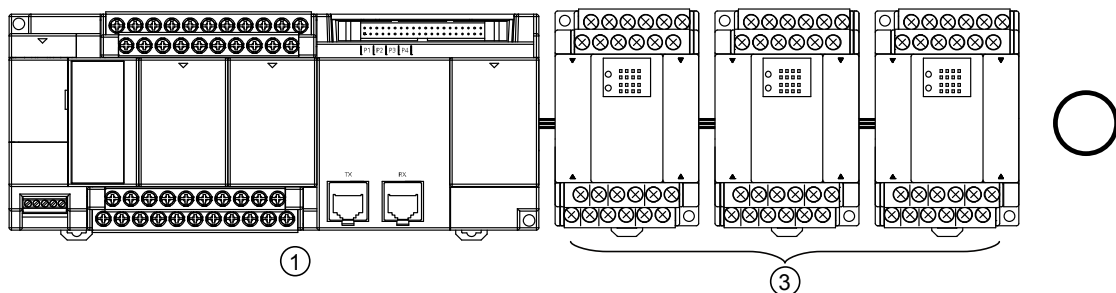

1.4.2 Restrictions on FP-X Expansion Adapter

■ Expansion position of FP-X expansion FP0 adapter

- With the FP-X expansion FP0 adapter, up to three FP0 expansion units can be connected.
- When using the FP-X expansion FP0 adapter, up to seven FP-X expansion units can be connected.
- The end of the FP-X expansion bus can only connect with one FP-X expansion FP0 adapter. Please expand on the right side of FP-X expansion units.

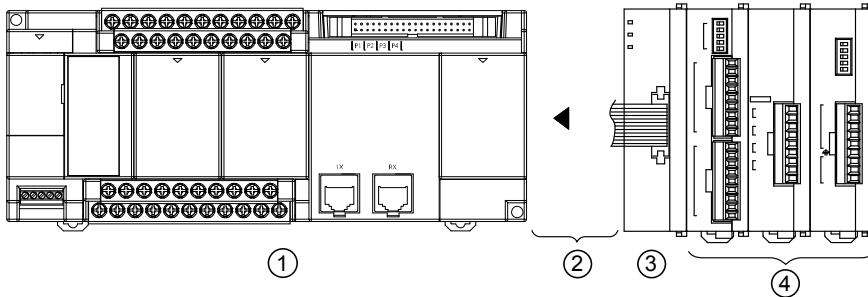

①	FP-XH M8N Control Unit	②	FP-X Expansion Unit	③	FP-X Expansion FP0 Adapter	④	FP0 Expansion Unit High Function Unit
---	---------------------------	---	---------------------------	---	----------------------------------	---	---

■ Expansion sequence of FP0 expansion unit / FP0 high functional unit

- Please connect the FP0 thermocouple input unit to the right side of the other FP0 units. Connecting to the left side reduces overall accuracy.
- Please connect the FP0 CC-Link unit to the right side of the other FP0 units. No expansion connector.

1.4.3 Restrictions on Add-on cassette Combination

■ **Add-on cassette installation position (1)**

- The FP-XH M8N control unit contains 2 add-on cassette installation parts.

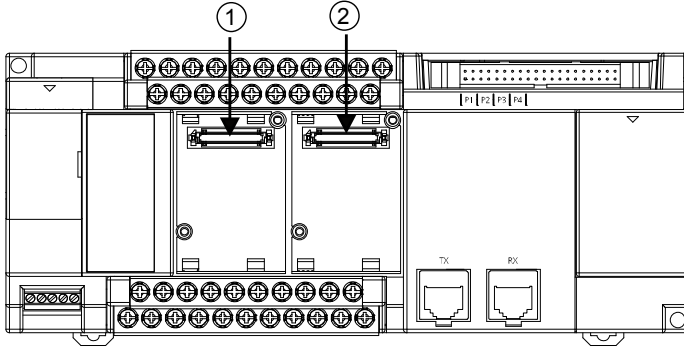

①	Cassette installation part 1	②	Cassette installation part 2
---	------------------------------	---	------------------------------

■ **Add-on cassette installation position (2)**

- Function and communication cassette can be overlapped and installed into the same cassette installation part. In this case, make sure the communication cassette is installed over the function cassette.

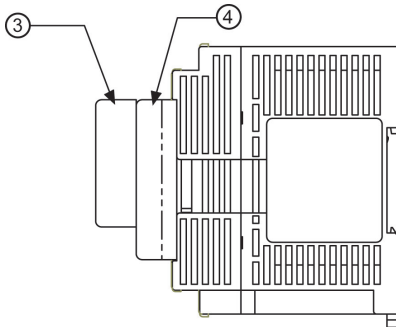

③	Communication cassette	④	Function cassette
---	------------------------	---	-------------------

■ **Number of add-on cassettes that can be Installed**

- Up to 2 function cassettes and 2 communication cassettes can be installed.

■ Add-on cassette type and installation location (A: Available, C: Conditional, Blank: Not available)

Cassette type			Installation part of the control unit	
Type	Product Name	No.	Cassette installation part 1	Cassette installation part 2
Communication cassette (note 1)	Communication cassette	AFPX-COM1	A (Note 2)	A (Note 2)
		AFPX-COM2	A	A
		AFPX-COM3	A	A
		AFPX-COM4	A	A
		AFPX-COM5	A	A
		AFPX-COM6	A	A
Function cassette (Note 3)	Analog input cassette	AFPX- AD2	A	A
	Analog output cassette	AFPX-DA2	A	A
	Analog I/O cassette	AFPX-A21	A	A
	Thermocouple cassette	AFPX-TC2	A	A
	Temperature measuring resistor cassette	AFPX-RTD2	A	A
	Input cassette	AFPX-IN8	A	A
	Output cassette	AFPX-TR8	A	A
	Output cassette	AFPX-TR6P	A	A
	Input / output cassette	AFPX-IN4T3	A	A
	Pulse input / output cassette	AFPX-PLS	(Note 4)	(Note 4)
	Master memory cassette	AFPX-MRTC	C (note 5)	C (note 5)

(Note 1): When installed with the function cassette together, mount it over the function cassette.

(Note 2): RS / CS control available for AFPX-COM1.

(Note 3): When installing the function cassette on FP-XH M8N control unit, it can be installed at cassette installation part 1 or cassette installation part 2.

(Note 4): You can not install pulse input and output cassette on the FP-XH M8N control unit. If installed, a self-diagnosis error will occur (27: Unit installation is restricted).

(Note 5): Only one FP-X master memory cassette can be installed. A self-diagnosis error will occur if 2 sets are installed (27: Unit installation is restricted).

1.4.4 Restrictions on Communication Function

- When using the standard communication port and communication cassette of the control unit, the following limitations exist depending on the different functions of use.
- The communication port number assigned varies according to the cassette installation position.

■ Type of communication port / communication cassette (A: available, Blank: Not available)

Product no.	Communication Interface	Communication Port No. Assigned				
		Main unit	Cassette installation part 1		Cassette installation part 2	
		COM0	COM1	COM2	COM3	COM4
Control unit standard configuration	RS-232C (3-wire) × 1 channel	A				
AFPX-COM1	RS-232C (5-wire) × 1 channel		A		A	
AFPX-COM2	RS-232C (3-wire) × 2 channel		A	A	A	A
AFPX-COM3	RS-485 / RS-422 × 1 channel		A		A	
AFPX-COM4	RS-485 × 1 channel		A		A	
	RS-232C (3-wire) × 1 channel			A		A
AFPX-COM5	Ethernet × 1 channel		A		A	
	RS-232C (3-wire) × 1 channel			A		A
AFPX-COM6	RS-485 × 2 channel		A	A	A	A

(Note 1): With 5-wire RS-232C, the RS / CS control can be enabled for the RS-232C port of the AFPX-COM1.

(Note 2): Choose either of the RS-485 or RS-422 when using AFPX-COM3. It can be shifted by the switch on the communication cassette.

(Note 3): AFPX-COM4 can use RS-485 × 1 channel and RS-232C (3-wire) × 1 channel.

(Note 4): AFPX-COM5 can use Ethernet × 1 channel and RS-232C (3-wire) × 1 channel.

■ Function of the communication port (A: Available, C: Conditional, Blank: Not available)

Communication Function Used		Communication Port No. Assigned				
		Main unit	Cassette installation part 1		Cassette installation part 2	
		COM0	COM1	COM2	COM3	COM4
PLC Link		C	C			
MEWTOCOL-COM	Master station	A	A	A	A	A
	Slave	A	A	A	A	A
MODBUS-RTU	Master station	A	A	A	A	
	Slave	A	A	A	A	
General Communication		A	A	A	A	

(Note 1): PLC link can only use either the COM0 port comes with the control unit or COM1 port on the cassette.

(Note 2): The COM4 port only supports MEWTOCOL-COM communication. In addition, the communication parameters (station number, communication format, communication speed) when the power is ON are same as the settings of the COM3 port. After RUN, you can also change the conditions by SYS1 instruction.

1.5 Restrictions on Servo Amplifier

1.5.1 Restrictions on Parameter Settings

Some parameters of AMPs may affect the control of the control unit. Set parameters according to the following description.

■ A6N/A5N parameters

No.	Parameter name	Factory default setting	Settings
Pr0.00	Rotational direction setup	1	The FP-XH M8N Control Unit automatically changes this parameter. Do not change this parameter.
Pr0.01	Control mode setup	0	Use "setting value 0 (semi-closed control)".
Pr0.08	Output pulse counts per one motor revolution	0	Factory default setting When Pr.0.08=0, Pr.0.09=1, Pr.0.10=1, position command input is position command. (Note 1)
Pr0.09	Numerator of electronic gear	1	
Pr0.10	Denominator of electronic gear	1	
Pr4.00 -Pr4.07	SI1-SI8 input selection	(Note 2)	The connection method and settings vary according to the home return method used.
Pr4.31	Positioning complete (In-position) range	10	The FP-XH M8N Control Unit automatically changes this parameter. Do not change this parameter. Also, the setting unit and the calculation method of deviation depend on the Pr5.20 "Position setup unit select".
Pr5.04	Over-travel inhibit input setup	1	Use "setting value 1 (Over-travel inhibit input is disabled)".
Pr5.21	Selection of torque limit	1	The FP-XH M8N Control Unit automatically changes this parameter. Do not change this parameter.
Pr7.20	RTEX communication cycle setup	3	Use "setting value 3 (0.5 ms)".
Pr7.21	RTEX command updating cycle ratio setting	2	Use "setting value 2 (2 times)".
Pr7.22	RTEX function extended setup 1	0	Use "setting value 0 (16-byte mode)".
Pr7.23	RTEX function extended setup 2	18	The FP-XH M8N Control Unit automatically changes this parameter. Do not change this parameter.
Pr7.25	RTEX Speed unit setup	0	Change to "setting value 1 (command unit/s)".

(Note 1) For details of Pr0.08 to Pr0.10, refer to "Technical Reference of AC Servo Driver A6N series" or "Technical Reference of AC Servo Driver A5N series".

(Note 2) The factory default settings of Pr4.00 to Pr4.07 vary according to parameter numbers.



◆ KEY POINTS

- In the case of the factory default settings of Pr.0.08=0, Pr.0.09=1 and Pr.0.10=1, the electronic gear ratio is 1/1, and the encoder resolution is "Command pulse counts per one motor revolution".
- If you need to increase the rotation speed, set the bot parameters Pr0.08 and Pr0.09 to "0". The value set in the parameter Pr0.10 functions as "Command pulse counts per one motor revolution".

1.5.2 Combination of Parameters and Home Return Methods

When using either "DOG method 2" or "Limit method 2" for the home return method, change the parameters on the AMP side to the pattern B described as below. If the operation is executed with the pattern A setting (factory default setting), the latch input allocation error protection (error code 0821H:33-8) will occur.

■ Home return method and AMP parameter setting (A: Available, Blank: Not available)

FP-XH M8N Home return method	Reference home position	A6N/A5N parameters	
		Pattern A	Pattern B
DOG method 1	Home (Z phase)	A	A
DOG method 2	Near home (DOG)		A
DOG method 3	Home (Z phase)	A	A
Limit method 1	Home (Z phase)	A	A
Limit method 2	Limit - (NOT) / Limit + (POT)		A
Z phase method	Home (Z phase)	A	A
Stop-on-contact method 1	Mechanical stop mechanism such as a stopper	A	A
Stop-on-contact method 2	Home (Z phase)	A	A
Data set method	-	A	A

■ Pattern A (Factory default setting)

Parameter no.	X4 connector		Parameter value (HEX)	Pin assign setting		Revised items
	Terminal name	Terminal no.				
Pr 4.00	SI1	5	00323232H	SI-MON5	A contact	
Pr 4.01	SI2	7	00818181H	POT	B contact	A
Pr 4.02	SI3	8	00828282H	NOT	B contact	A
Pr 4.03	SI4	9	002E2E2EH	SI-MON1	A contact	
Pr 4.04	SI5	10	00222222H	HOME	A contact	
Pr 4.05	SI6	11	00212121H	EXT2	A contact	A
Pr 4.06	SI7	12	002B2B2BH	EXT3	A contact	A
Pr 4.07	SI8	13	00313131H	SI-MON4	A contact	

■ Pattern B (After change)

Parameter no.	X4 connector		Parameter value (HEX)	Pin assign setting		Revised items
	Terminal name	Terminal no.				
Pr 4.00	SI1	5	00323232H	SI-MON5	A contact	
Pr 4.01	SI2	7	00000000H	Invalid		A
Pr 4.02	SI3	8	00000000H	Invalid		A
Pr 4.03	SI4	9	002E2E2EH	SI-MON1	A contact	
Pr 4.04	SI5	10	00222222H	HOME	A contact	
Pr 4.05	SI6	11	00010101H	POT	A contact	A
Pr 4.06	SI7	12	00020202H	NOT	A contact	A
Pr 4.07	SI8	13	00313131H	SI-MON4	A contact	

2

Control Unit Specifications

2.1 Parts Name and Functions

2.1.1 Control Unit

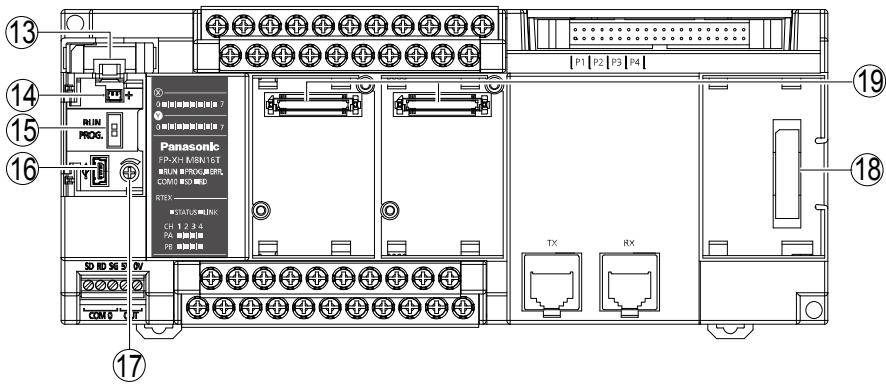
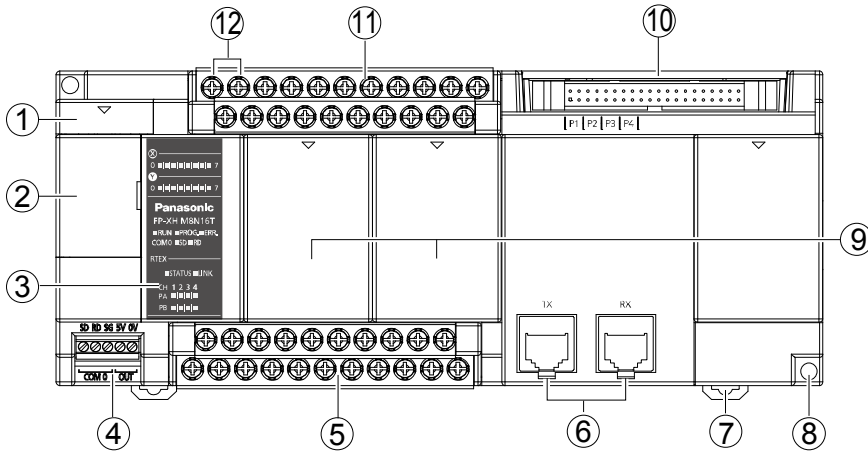

■ Name and Function of Each Part

No.	Name	Function	
①	Battery cover	Backup battery insertion space for options.	
②	Operating unit cover	Has built-in battery connector, RUN / PROG. mode switch, USB port connector and analog potentiometer.	
③	Status indicator LEDs / I/O indicator LEDs	Indicates the operation mode, error occurrence state, communication state of COM0 port and input and output states. Also displays the input and output states of the interface part for motion control.	
④	COM0 port	3-wire RS-232C port. Also equipped with a 5V power supply terminal for connecting to GT series monitor.	
⑤	Output terminal	Connect with the output device.	
⑥	Network (RTEX) connector	Used for the network connection of RTEX.	
⑦	DIN hook	Used for DIN rail fixing.	
⑧	Mounting hole	Used for mounting the unit with screws.	
⑨	Cassette installation part cover	Installation space for communication cassette and function cassette of the options.	
⑩	I/F for pulse input	The pulse input function can be used. Pulse inputs of 4 channels are laid out.	
⑪	Input terminal	Connect with input devices.	
⑫	Power supply terminals	Connected to the drive control unit power supply.	
⑬	Battery holder	When using the clock/calendar function, it is used to install a special battery when expanding the backup area of memory area for operation. The special Battery (AFPXHBATT) is required to purchase separately.	
⑭	Battery connector	Insert special battery (AFPXHBATT) connector.	
⑮	RUN / PROG. mode switch	RUN (upper)	Set to RUN mode. Program execution begins.
		PROG. (lower)	Set to programming mode.
⑯	USB port connector	Connecting to a PC using the tool software.	
⑰	Analog potentiometer	The special DT value changes when rotating potentiometer. It can be applied to analog timers etc.	
⑱	Expansion unit connector	Connect with an expansion cable for installing expansion unit.	
⑲	Add-on cassette connector	For installing an optional add-on cassette (communication cassette or function cassette).	

(Note 1): Whether the switch is on "RUN" or "PROG", the mode can be switched by tool software via remote operation. When the power is reconnected, it will operate under the mode at the switch position.

2.1.2 Status Indicator LEDs

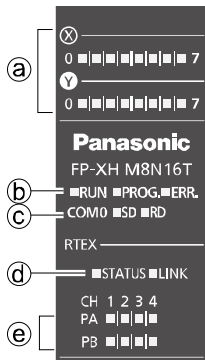

No.	Controller Display	Color	Description		
a	X	Green	Indicate the status of inputs.		
	Y	Green	Indicate the status of outputs.		
b	RUN	Green	On	Lighted when running the program in RUN mode.	
			Flashes	When performing the mandatory input and output function, RUN / PROGLED will flash alternately.	
	PROG.	Green	On	Lighted when stopping running in PROG. mode.	
			Flashes	When performing the mandatory input and output function, RUN / PROGLED will flash alternately.	
	ERR.	Red	On	The light is on during hardware exceptions, program operation stagnation and monitoring timer operation.	
			Flashes	Flashing when detecting errors through self diagnosis.	
c	COM0	SD	Green	Flashes when COM0 port is sending data.	
		RD	Green	Flashes when COM0 port is receiving data.	
d	RTEX I/F	STATUS	Green	On	Network establishment
			Green	Flashes	Waiting for network establishment
		LINK	Green	Flashes	Normal connection (The TX of the sending node and the RX of the own node are electrically connected properly.)
				Off	Not connected (The power supply of the sending node is not on or a cable is disconnected, etc.)
e	Pulse input	PA	Green	Lit during Phase-A pulse input (Note 1)	
		PB	Green	Lit during Phase-B pulse input (Note 1)	

(Note 1): pulse input signals (PA) and (PB) indicate input status of pulse input circuit part.

2.1.3 COM0 Port Specifications

- General-purpose 3-wire RS-232C port.
- Equipped with a 5 V power supply terminal for supplying power to the GT02 / GT02L series programmable display.

■ Terminal arrangement

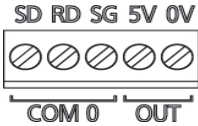

Controller Display		Description	
COM 0	SD	Send data (unit → external device)	General-purpose 3-wire RS-232C port.
	RD	Receive data (external device → unit)	
	SG	Signal ground	
OUT	5V	As power supply for GT series display, 5 VDC output.	
	0V		

2.2 Power Supply Specifications

■ DC Power Supply (AFPXHM8N16PD)

Item	Specification
Rated voltage	24 VDC
Voltage regulation range	21.6 to 26.4 VDC
Inrush current	12 A or less (at 25 °C)
Momentary power off time	10 ms
Internal power supply part Guaranteed life	30,000 h (at 55 °C)
Fuse	Built-in (Cannot be replaced)
Insulation system	Non-isolated
Terminal screw	M3

■ List of consumption current

When using 24 VDC
200 mA or less

2.3 Input / Output Specifications (General-purpose input/output part)

2.3.1 Input Specifications

■ Specification

Item	Specification	
Rated input voltage	24 VDC	
Operating voltage range	21.6 - 26.4 VDC	
Rated input current	Approx. 4.7mA	
Input points per common	8 points/ COM (+/- polarity of the input power supply are both allowable)	
Minimum ON voltage / minimum ON current	19.2 VDC / 3 mA	
Maximum OFF voltage / maximum OFF current	2.4 VDC / 1 mA	
Input impedance	Approx. 5.1 k Ω	
Response time	OFF \rightarrow ON	135 μ s or less (general input) 50 μ s or less (high-speed counter, pulse catch, interrupt input setting)
	ON \rightarrow OFF	Ditto
Operating mode indicator	LED	

■ Internal circuit diagram

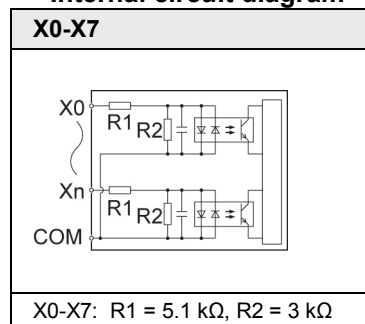

2.3.2 Output Specifications

■ Specification

Item		Specification
Output type		PNP open collector
Rated load voltage		5 - 24 VDC
Allowable load voltage range		4.75 - 26.4 VDC
Rated load current		0.5 A
Max. inrush current		1.5 A
Off state leakage current		1 μ A or less
ON-state max. voltage drop		0.3 VDC or less
Output points per common		8 points/common
Response time	OFF \rightarrow ON	1 ms or less
	ON \rightarrow OFF	1 ms or less
Surge absorber		Zener diode
Operating mode indicator		LED

■ Internal circuit diagram

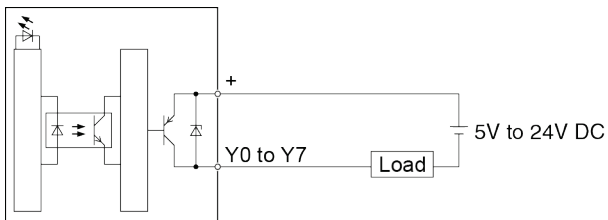

2.4 Input Specifications (Pulse Input Part)

■ Pulse input

Item		Specification
Rated input voltage		5 VDC
Operating voltage range		3.5-5.25 V DC
Rated input current		Approx. 6.9mA
Input points per common		Independent common
Minimum ON voltage / minimum ON current		3V DC/3.2 mA
Maximum OFF voltage / maximum OFF current		1V DC/0.5 mA
Input impedance		Approx. 720Ω
Response time	OFF → ON	0.5 μs or less
	ON → OFF	0.5 μs or less
Operating mode indicator		LED

■ Internal circuit diagram

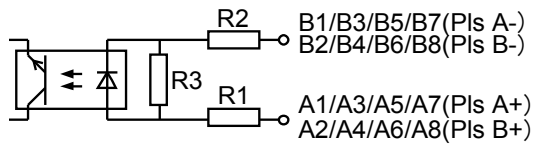

R1 = Approx. 360Ω, R2 = Approx. 360Ω, R3 = Approx. 2.7kΩ

■ Terminal layout diagram

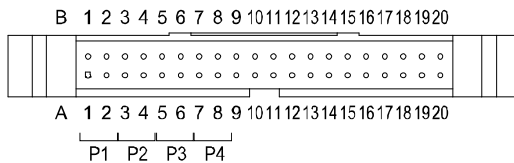

Pin no.	B1	B2	B3	B4	B5	B6	B7	B8
Signal name	PlsA(-)	PlsB(-)	PlsA(-)	PlsB(-)	PlsA(-)	PlsB(-)	PlsA(-)	PlsB(-)
Pin no.	A1	A2	A3	A4	A5	A6	A7	A8
Signal name	PlsA(+)	PlsB(+)	PlsA(+)	PlsB(+)	PlsA(+)	PlsB(+)	PlsA(+)	PlsB(+)
	CH1		CH2		CH3		CH4	

3

I/O Allocation

3.1 Basic I/O Assignment

3.1.1 Counting Method of I/O Numbers

■ **Counting method and representation of I/O numbers**

- I/O numbers are counted in 16 points, representing the next bit combination of device type symbol and decimal and hexadecimal numbers.
- For external input, represented as X0-X9, XA-XF. For external output, represented as Y0-Y9, YA-YF.

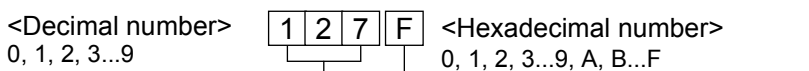

3.1.2 I/O Number Assignment Method

■ **I/O numbers of control unit**

I/O numbers are assigned a fixed area.

■ **I/O numbers of expansion unit**

The starting number assigned to each expansion unit will change depending on the installation location.

■ **I/O number assigned to each function cassette**

Depending on the installation location, I/O number assigned a fixed area.

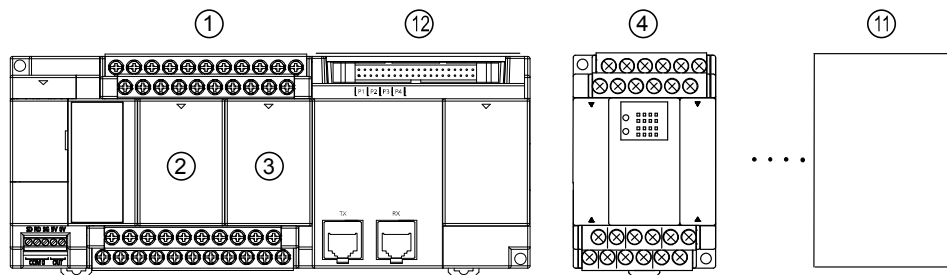

■ I/O numbers list

Unit Type and Installation Location		Input		Output	
		I/O Number		I/O Number	
①	Control unit	X0-X9F	WX0-WX9	Y0-Y9F	WY0-WY9
②	Cassette installation part 1 (slot 0)	X100-X19F	WX10-WX19	Y100-Y19F	WY10-WY19
③	Cassette installation part 2 (slot 1)	X200-X29F	WX20-WX29	Y200-Y29F	WY20-WY29
④	1st expansion	X300-X39F	WX30-WX39	Y300-Y39F	WY30-WY39
⑤	2nd expansion	X400-X49F	WX40-WX49	Y400-Y49F	WY40-WY49
⑥	3rd expansion	X500-X59F	WX50-WX59	Y500-Y59F	WY50-WY59
⑦	4th expansion	X600-X69F	WX60-WX69	Y600-Y69F	WY60-WY69
⑧	5th expansion	X700-X79F	WX70-WX79	Y700-Y79F	WY70-WY79
⑨	6th expansion	X800-X89F	WX80-WX89	Y800-Y89F	WY80-WY89
⑩	7th expansion	X900-X99F	WX90-WX99	Y900-Y99F	WY90-WY99
⑪	8th expansion	X1000-X109F	WX100-WX109	Y1000-Y109F	WY100-WY109
⑫	Motion Control Part	X1100-X141F	WX110-WX141	Y1100-Y141F	WY110-WY141

(Note): The I/O number can be used practically varies from the types of cassettes and expansion units.

3.2 List of I/O Numbers for Units

3.2.1 FP-XH M8N Control Unit (General-purpose I/O Part)

■ I/O numbers list (General-purpose input and output part)

Input		Output	
Input Points	I/O Number	Output Points	I/O Number
8 points	X0-X7	8 points	Y0-Y7

3.2.2 FP-XH M8N Control Unit (Motion Control Part)

■ List of I/O numbers (input)

Signal name	I/O number							
	Axis 1	Axis 2	Axis 3	Axis 4	Axis 5	Axis 6	Axis 7 (Virtual)	Axis 8 (Virtual)
Link establishment annunciation	X1100							
Cam table reading completion annunciation	X1102							
Cam table rewriting completion annunciation	X1103							
Tool operation	X1104							
Axis group setting done	X1105							
Recalculation done	X1107							
System restart annunciation	X110F							
Servo lock	X1120	X1121	X1122	X1123	X1124	X1125	X1126	X1127
BUSY	X1130	X1131	X1132	X1133	X1134	X1135	X1136	X1137
Operation done	X1140	X1141	X1142	X1143	X1144	X1145	X1146	X1147
Home return done	X1150	X1151	X1152	X1153	X1154	X1155	X1156	X1157
Near home	X1170	X1171	X1172	X1173	X1174	X1175	X1176	X1177
Each axis connection confirmation	X1180	X1181	X1182	X1183	X1184	X1185	X1186	X1187
Auxiliary contact	X1190	X1191	X1192	X1193	X1194	X1195	X1196	X1197
Limit +	X1200	X1202	X1204	X1206	X1208	X120A	X120C	X120E
Limit -	X1201	X1203	X1205	X1207	X1209	X120B	X120D	X120F
Error annunciation	X1230	X1231	X1232	X1233	X1234	X1235	X1236	X1237
Warning annunciation	X1240	X1241	X1242	X1243	X1244	X1245	X1246	X1247
RTEX general-purpose input 1	X1250	X1252	X1254	X1256	X1258	X125A	X125C	X125E
RTEX general-purpose input 2	X1251	X1253	X1255	X1257	X1259	X125B	X125D	X125F
Synchronous setting done	X1270	X1271	X1272	X1273	X1274	X1275	X1276	X1277
Synchronous cancel active annunciation	X1280	X1281	X1282	X1283	X1284	X1285	X1286	X1287
Synchronous slave gear ratio change state annunciation	X1310	X1311	X1312	X1313	X1314	X1315	X1316	X1317
Synchronous slave clutch connection state annunciation	X1330	X1331	X1332	X1333	X1334	X1335	X1336	X1337
Positioning speed change request reception annunciation	X1380	X1381	X1382	X1383	X1384	X1385	X1386	X1387
Positioning movement amount change request reception annunciation	X1390	X1391	X1392	X1393	X1394	X1395	X1396	X1397

■ List of I/O numbers (output)

Signal name	I/O number							
	Axis 1	Axis 2	Axis 3	Axis 4	Axis 5	Axis 6	Axis 7 (Virtual)	Axis 8 (Virtual)
System stop	Y1100							
Cam table reading request	Y1102							
Cam table rewriting request	Y1103							
Axis group setting change request	Y1105							
Recalculation request	Y1107							
All axes error clear request	Y110C							
All axes warning clear request	Y110D							
Servo ON request	Y1120	Y1121	Y1122	Y1123	Y1124	Y1125	Y1126	Y1127
Servo OFF request	Y1130	Y1131	Y1132	Y1133	Y1134	Y1135	Y1136	Y1137
Positioning start	Y1140	Y1141	Y1142	Y1143	Y1144	Y1145	Y1146	Y1147
Home return start	Y1150	Y1151	Y1152	Y1153	Y1154	Y1155	Y1156	Y1157
Forward JOG	Y1160	Y1162	Y1164	Y1166	Y1168	Y116A	Y116C	Y116E
Reverse JOG	Y1161	Y1163	Y1165	Y1167	Y1169	Y116B	Y116D	Y116F
Emergency stop	Y1180	Y1181	Y1182	Y1183	Y1184	Y1185	Y1186	Y1187
Deceleration stop	Y1190	Y1191	Y1192	Y1193	Y1194	Y1195	Y1196	Y1197
Pulsar input enabled	Y1200	Y1201	Y1202	Y1203	Y1204	Y1205	Y1206	Y1207
J-point speed change	Y1210	Y1211	Y1212	Y1213	Y1214	Y1215	Y1216	Y1217
J point positioning start	Y1220	Y1221	Y1222	Y1223	Y1224	Y1225	Y1226	Y1227
Error clear request	Y1230	Y1231	Y1232	Y1233	Y1234	Y1235	Y1236	Y1237
Warning clear request	Y1240	Y1241	Y1242	Y1243	Y1244	Y1245	Y1246	Y1247
RTEX general-purpose output 1	Y1250	Y1252	Y1254	Y1256	Y1258	Y125A	Y125C	Y125E
RTEX general-purpose output 2	Y1251	Y1253	Y1255	Y1257	Y1259	Y125B	Y125D	Y125F
Synchronous setting request	Y1270	Y1271	Y1272	Y1273	Y1274	Y1275	Y1276	Y1277
Synchronous cancel request	Y1280	Y1281	Y1282	Y1283	Y1284	Y1285	Y1286	Y1287
Synchronous slave gear ratio change request	Y1310	Y1311	Y1312	Y1313	Y1314	Y1315	Y1316	Y1317
Synchronous slave clutch ON request	Y1330	Y1331	Y1332	Y1333	Y1334	Y1335	Y1336	Y1337
Synchronous slave clutch OFF request	Y1340	Y1341	Y1342	Y1343	Y1344	Y1345	Y1346	Y1347
Positioning speed change request	Y1380	Y1381	Y1382	Y1383	Y1384	Y1385	Y1386	Y1387
Positioning movement amount change request	Y1390	Y1391	Y1392	Y1393	Y1394	Y1395	Y1396	Y1397

3.2.3 FP-X Expansion Unit

■ I/O numbers list

Unit Type	Input		Output	
	Input Points	I/O Number	Output Points	I/O Number
E16	8 points	X300-X307	8 points	Y300-Y307
E30	16 points	X300-X309, X30A-X30F	14 points	Y300-Y309, Y30A-Y30D
E16X	16 points	X300-X309, X30A-X30F	-	-
E14YR	-	-	14 points	Y300-Y309, Y30A-Y30D

(Note): I/O numbers in the above table represent the I/O number for expansion units connected to the first unit. The I/O number varies from the installation order.

3.2.4 FP-X Function Cassette

■ I/O numbers list (analog input and output cassettes)

Installation Location	Type	Input		Output	
		Input Points	I/O Number	Output Points	I/O Number
Cassette mounting part 1	Analog input cassette AD2	2ch	WX10, WX11	-	-
	Analog output DA2	-	-	2ch	WY10, WY11
	Analog input and output cassette A21	2ch	WX10, WX11	1ch	WY10
	TC2 thermocouple input cassette	2ch	WX10, WX11	-	-
	RTD input cassette RTD2	2ch	WX10, WX11	-	-
Cassette mounting part 2	Analog input cassette AD2	2ch	WX20, WX21	-	-
	Analog output DA2	-	-	2ch	WY20, WY21
	Analog input and output cassette A21	2ch	WX20, WX21	1ch	WY20
	TC2 thermocouple input cassette	2ch	WX20, WX21	-	-
	RTD input cassette RTD2	2ch	WX20, WX21	-	-

■ I/O numbers list (digital input and output cassettes)

Installation Location	Type	Input		Output	
		Input Points	I/O Number	Output Points	I/O Number
Cassette mounting part 1	Input cassette IN8	8 points	X100-X107	-	-
	Output cassette TR8	-	-	8 points	Y100-Y107
	Output cassette TR6P	-	-	6 points	Y100-Y105
	Input and output cassette IN4T3	4 points	X100-X103	3 points	Y100-Y102
Cassette mounting part 2	Input cassette IN8	8 points	X200-X207	-	-
	Output cassette TR8	-	-	8 points	Y200-Y207
	Output cassette TR6P	-	-	6 points	Y200-Y205
	Input and output cassette IN4T3	4 points	200-X203	3 points	Y200-Y202

3.3 Assignment of FP0 Expansion Units

3.3.1 I/O Number Assignment Method

■ I/O numbers of FP0 expansion units and FP0 high function units

- The starting number assigned to each FP0 expansion block varies from the installation location of FP-X expansion FP0 adapters.
- The starting number assigned to each unit varies from the installation sequences of FP0 expansion units and FP0 high function units.

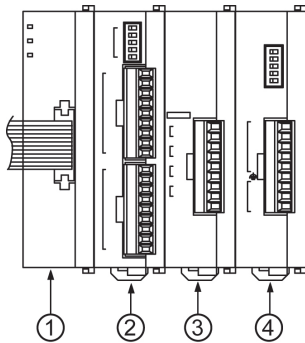

①	FP-X Expansion FP0 Adapter	②	FP0 Expansion Unit 1	③	FP0 Expansion Unit 2	④	FP0 Expansion Unit 3
---	----------------------------------	---	-------------------------	---	-------------------------	---	-------------------------

■ I/O numbers list

FP-X Expansion FP0 Adapter Installation Location	Installation Sequence of FP0 Expansion Units					
	Expansion Unit 1		Expansion Unit 2		Expansion Unit 3	
	Input	Output	Input	Output	Input	Output
1st expansion	X300-X31F	Y300-Y31F	X320-X33F	Y320-Y33F	X340-X35F	Y340-Y35F
2nd expansion	X400-X41F	Y400-Y41F	X420-X43F	Y420-Y43F	X440-X45F	Y440-Y45F
3rd expansion	X500-X51F	Y500-Y51F	X520-X53F	Y520-Y53F	X540-X55F	Y540-Y55F
4th expansion	X600-X61F	Y600-Y61F	X620-X63F	Y620-Y63F	X640-X65F	Y640-Y65F
5th expansion	X700-X71F	Y700-Y71F	X720-X73F	Y720-Y73F	X740-X75F	Y740-Y75F
6th expansion	X800-X81F	Y800-Y81F	X820-X83F	Y820-Y83F	X840-X85F	Y840-Y85F
7th expansion	X900-X91F	Y900-Y91F	X920-X93F	Y920-Y93F	X940-X95F	Y940-Y95F
8th expansion	X1000 -X101F	Y1000 -Y101F	X1020 -X103F	Y1020 -Y103F	X1040 -X105F	Y1040 -Y105F

(Note): The I/O number can be used practically varies from the types of cassettes and expansion units.

3.3.2 Types and I/O Numbers of FP0R Expansion Units

I/O numbers when the FP-X expansion FP0 adapter connecting as the first expansion unit of the control unit are shown below.

■ I/O numbers list (first expansion unit)

Unit Type		Points Assigned	Expansion Unit 1	Expansion Unit 2	Expansion Unit 3
FP0R expansion unit	AFP0RE8X	Input (8 points)	X300 - X307	X320 - X327	X340 - X347
	AFP0RE8R	Input (4 points)	X300 - X303	X320 - X323	X340 - X343
		Output (4 points)	Y300 - Y303	Y320 - Y323	Y340 - Y343
	AFP0RE8YT/P AFP0RE8YR	Output (8 points)	Y300 - Y307	Y320 - Y327	Y340 - Y347
	AFP0RE16X	Input (16 points)	X300 - X30F	X320 - X32F	X340 - X34F
	AFP0RE16R AFP0RE16T/P	Input (8 points)	X300 - X307	X320 - X327	X340 - X347
		Output (8 points)	Y300 - Y307	Y320 - Y327	Y340 - Y347
	AFP0RE16YT/P	Input (16 points)	Y300 - Y30F	Y320 - Y32F	Y340 - Y34F
AFP0RE32T/P	Input (16 points)	X300 - X30F	X320 - X32F	X340 - X34F	
	Output (16 points)	Y300 - Y30F	Y320 - Y32F	Y340 - Y34F	
FP0R analog input unit	AFP0RAD4 (Note 1) AFP0RAD8	Input (16 points) CH0,2,4,6	WX30 (X300~X30F)	WX32 (X320-X32F)	WX34 (X340-X34F)
		Input (16 points) CH1,3,5,7	WX31 (X310-X31F)	WX33 (X330~X33F)	WX35 (X350~X35F)
		Output (16 points) Range setting	WY30 (Y300~Y30F)	WY32 (Y320-Y32F)	WY34 (Y340-Y34F)
		Output (16 points) Averaging setting	WY31 (Y310-Y31F)	WY33 (Y330-Y33F)	WY35 (Y350-Y35F)
FP0R analog output unit	AFP0RDA4	Input (32 points) Status	WX30 (X300~X30F)	WX32 (X320-X32F)	WX34 (X340-X34F)
			WX31 (X310-X31F)	WX33 (X330~X33F)	WX35 (X350~X35F)
		Output (16 points) CH0,2 (Note 2)	WY30 (Y300~Y30F)	WY32 (Y320-Y32F)	WY34 (Y340-Y34F)
FP0R analog input output unit	AFP0RAD4 (Note 3) AFP0RA42	Input (16 points) CH0,2	WX30 (X300~X30F)	WX32 (X320-X32F)	WX34 (X340-X34F)
		Input (16 points) CH1,3	WX31 (X310-X31F)	WX33 (X330~X33F)	WX35 (X350~X35F)
		Output (16 points) CH0 (Note 4)	WY30 (Y300~Y30F)	WY32 (Y320-Y32F)	WY34 (Y340-Y34F)
		Output (16 points) CH1 (Note 4)	WY31 (Y310-Y31F)	WY33 (Y330-Y33F)	WY35 (Y350-Y35F)

(Note 1): processing data of CH0-CH3 when AFP0RAD4.

(Note 2): also used for switching output ranges in 14-digit mode.

(Note 3): processing data of input CH0/CH1 and output CH0 when AFP0RA21.

(Note 4): also used for switching of output ranges, averaging setting upon input, and output range in 14-digit mode.

3.3.3 Types and I/O Numbers of FP0 Expansion Units

I/O numbers when the FP-X expansion FP0 adapter connecting as the first expansion unit of the control unit are shown below.

■ I/O numbers list (first expansion unit)

Unit Type		Points Assigned	Expansion Unit 1	Expansion Unit 2	Expansion Unit 3
FP0 expansion unit	FP0-E8X	Input (8 points)	X300 - X307	X320 - X327	X340 - X347
	FP0-E8R	Input (4 points)	X300 - X303	X320 - X323	X340 - X343
		Output (4 points)	Y300 - Y303	Y320 - Y323	Y340 - Y343
	FP0-E8YT/P FP0-E8YR	Output (8 points)	Y300 - Y307	Y320 - Y327	Y340 - Y347
	FP0-E16X	Input (16 points)	X300 - X30F	X320 - X32F	X340 - X34F
	FP0-E16R FP0-E16T/P	Input (8 points)	X300 - X307	X320 - X327	X340 - X347
		Output (8 points)	Y300 - Y307	Y320 - Y327	Y340 - Y347
	FP0-E16YT/P	Output (16 points)	Y300 - Y30F	Y320 - Y32F	Y340 - Y34F
FP0-E32T/P	Input (16 points)	X300 - X30F	X320 - X32F	X340 - X34F	
	Output (16 points)	Y300 - Y30F	Y320 - Y32F	Y340 - Y34F	
FP0 analog I/O unit	FP0-A21	Input (16 points) CH0	WX30 (X300-X30F)	WX32 (X320-X32F)	WX34 (X340-X34F)
		Input (16 points) CH1	WX31 (X310-X31F)	WX33 (X330-X33F)	WX35 (X350-X35F)
		Output (16 points)	WY30 (Y300-Y30F)	WY32 (Y320-Y32F)	WY34 (Y340-Y34F)
FP0 A / D converter unit FP0 thermocouple unit	FP0-A80 FP0-TC4 FP0-TC8	Input (16 points) CH0, 2, 4, 6	WX30 (X300-X30F)	WX32 (X320-X32F)	WX34 (X340-X34F)
		Input (16 points) CH1, 3, 5, 7	WX31 (X310-X31F)	WX33 (X330-X33F)	WX35 (X350-X35F)
FP0 D / A converter unit	FP0-A04V FP0-A04I	Input (16 points)	WX30 (X300-X30F)	WX32 (X320-X32F)	WX34 (X340-X34F)
		Output (16 points) CH0, 2	WY30 (Y300-Y30F)	WY32 (Y320-Y32F)	WY34 (Y340-Y34F)
		Output (16 points) CH1, 3	WY31 (Y310-Y31F)	WY33 (Y330-Y33F)	WY35 (Y350-Y35F)
FP0 I/O link unit	FP0-IOL	Input 32 points	X300 - X31F	X320 - X33F	X340 - X35F
		Output 32 points	Y300 - Y31F	Y320 - Y33F	Y340 - Y35F

(Note 1): The channel datum of FP0 A / D converter unit (FP0-A80), FP0 thermocouple unit (FP0-TC4 / FP0-TC8) and FP0 D / A converter unit (FP0-A04V / FP0-A04I) are shifted, read and write according to the user program including conversion data switching flags.

(Note 2): For FP0 CC-Link slave unit, please confirm it according to the appropriate manual (the starting address must be read).

3.4 Detailed I/O Information of Motion Control Part

Contact allocation	Target axis	Name	Description	
WX110	X1100	All axes	Link establishment annunciation	Indicates that the network link was established, and announce the system started running.
	X1101	-	-	-
	X1102	All axes	Cam table reading completion annunciation	Reads cam tables when the cam table reading request contact (Y1102) turns ON. This contact turns ON after the completion of the reading of cam tables.
	X1103	All axes	Cam table rewriting completion annunciation	Reads cam tables when the cam table rewriting request contact (Y1103) turns ON. This contact turns ON after the completion of the rewriting of cam tables.
	X1104	All axes	Tool operation	Contact to indicate that the positioning unit is in tool operation. The start-up from I/O is not available during the Tool operation. If it performs, a warning will occur.
	X1105	All axes	Axis group setting done	Makes axis group setting changes in the unit with the axis group setting request contact (Y1105) turned ON after making setting changes in the axis group with the program. The contact turns ON after the completion of the setting changes.
	X1106	-	-	-
	X1107	All axes	Recalculation done	Starts the reconfiguration of positioning data (standard area) in the positioning memory when the recalculclation request contact (Y1107) turns ON. This contact turns OFF. This contact turns ON after the completion of the reconfiguration. Note) This contact is used to confirm the completion when a positioning table (standard area) is rewritten using a ladder program.
	X1108 -X110E	-	-	-
	X110F	All axes	System restart annunciation	This contact turns ON when the configuration of axes that is required for restarting the system is changed. When this contact is ON, the change setting will not be reflected unless the power supply is restarted.
WX111	X1110 -X111F	-	-	-
WX112	X1120	Axis 1	Servo lock	Turns on when the corresponding AMP is in the state of servo lock. As for X1126 and X1127, they are always ON when they are allocated to the virtual axes.
	X1121	Axis 2		
	X1122	Axis 3		
	X1123	Axis 4		
	X1124	Axis 5		
	X1125	Axis 6		
	X1126	Axis 7		
	X1127	Axis 8		
	X1128 -X112F	-	-	-

Contact allocation	Target axis	Name	Description	
WX113	X1130	Axis 1	BUSY Turns on when the corresponding axis is operating.	
	X1131	Axis 2		
	X1132	Axis 3		
	X1133	Axis 4		
	X1134	Axis 5		
	X1135	Axis 6		
	X1136	Axis 7 (virtual)		
	X1137	Axis 8 (virtual)		
	X1138 -X113F	-	-	-
WX114	X1140	Axis 1	Operation done Turns on when an operation command for the corresponding axis is completed. Turns ON when the operation for all the tables completed for P-point control and C-point control of the automatic operation. After this contact turns ON, the ON-state will continue until the next control is activated.	
	X1141	Axis 2		
	X1142	Axis 3		
	X1143	Axis 4		
	X1144	Axis 5		
	X1145	Axis 6		
	X1146	Axis 7 (virtual)		
	X1147	Axis 8 (virtual)		
	X1148 -X114F	-	-	-
WX115	X1150	Axis 1	Home return done Turns on when the home return operation for the corresponding axis completed. After this contact turns ON, the ON-state will continue until the next control is activated.	
	X1151	Axis 2		
	X1152	Axis 3		
	X1153	Axis 4		
	X1154	Axis 5		
	X1154	Axis 6		
	X1156	Axis 7 (virtual)		
	X1157	Axis 8 (virtual)		
	X1158 -X115F	-	-	-
WX116	X1160 -X116F	-	-	-

(Note 1): When using the virtual axes, the I/O numbers allocated vary according to the number of virtual axes.

When selecting virtual 1st axis	The I/O number of "Axis 8 (virtual)" in the above table is allocated to "virtual 1st axis".
When selecting virtual 1st and 2nd axes	The I/O number of "Axis 7 (virtual)" in the above table is allocated to "virtual 1st axis". The I/O number of "Axis 8 (virtual)" in the above table is allocated to "virtual 2nd axis".

Contact allocation	Target axis	Name	Description
WX117	X1170	Axis 1	Near home Monitor contact for the near home input connected to the corresponding AMP. As for X1176 and X1177, they are always OFF when they are allocated to the virtual axes.
	X1171	Axis 2	
	X1172	Axis 3	
	X1173	Axis 4	
	X1174	Axis 5	
	X1175	Axis 6	
	X1176	Axis 7 (virtual)	
	X1177	Axis 8 (virtual)	
	X1178 -X117F	-	
WX118	X1180	Axis 1	Each axis connection confirmation Turns on when the corresponding axis exists. As for X1186 and X1187, they are always ON when they are allocated to the virtual axes.
	X1181	Axis 2	
	X1182	Axis 3	
	X1183	Axis 4	
	X1184	Axis 5	
	X1185	Axis 6	
	X1186	Axis 7	
	X1187	Axis 8	
	X1188 -X118F	-	
WX119	X1190	Axis 1	Auxiliary contact Turns on when the corresponding positioning table of the corresponding axis is executed.
	X1191	Axis 2	
	X1192	Axis 3	
	X1193	Axis 4	
	X1194	Axis 5	
	X1194	Axis 6	
	X1196	Axis 7 (virtual)	
	X1197	Axis 8 (virtual)	
	X1198 -X119F	-	

(Note 1): When using the virtual axes, the I/O numbers allocated vary according to the number of virtual axes.

When selecting virtual 1st axis	The I/O number of "Axis 8 (virtual)" in the above table is allocated to "virtual 1st axis".
When selecting virtual 1st and 2nd axes	The I/O number of "Axis 7 (virtual)" in the above table is allocated to "virtual 1st axis". The I/O number of "Axis 8 (virtual)" in the above table is allocated to "virtual 2nd axis".

Contact allocation	Target axis	Name	Description	
WX120	X1200	Axis 1	Limit +	<p>Monitor contact of the limit + and \endash connected to the corresponding AMP.</p> <p>During the positioning operation, JOG operation or pulsar operation, performs the deceleration stop when the limit input that is an extension of the operating direction turned on.</p> <p>The deceleration stop time during the limit input can be changed in the positioning memory.</p> <p>It will be the contact for the automatic inversion when performing the home return.</p> <p>As for X120C to X120F, they are always ON when they are allocated to the virtual axes.</p>
	X1201		Limit -	
	X1202	Axis 2	Limit +	
	X1203		Limit -	
	X1204	Axis 3	Limit +	
	X1205		Limit -	
	X1206	Axis 4	Limit +	
	X1207		Limit -	
	X1208	Axis 5	Limit +	
	X1209		Limit -	
	X120A	Axis 6	Limit +	
	X120B		Limit -	
	X120C	Axis 7 (virtual)	Limit +	
	X120D		Limit -	
X120E	Aixs 8 (virtual)	Limit +		
X120F		Limit -		
WX121	X1210 -X121F	-	-	-
WX122	X1220 -X122F	-	-	-
WX123	X1230	Axis 1	Error annunciation	<p>Turns on when an error occurs on the corresponding axis. The contacts of all axes turn on if all axes have errors. The details of the error can be confirmed in the error annunciation area of the positioning memory.</p>
	X1231	Axis 2		
	X1232	Axis 3		
	X1233	Axis 4		
	X1234	Axis 5		
	X1235	Axis 6		
	X1236	Axis 7 (virtual)		
	X1237	Axis 8 (virtual)		
WX123	X1238 -X123F	-	-	-

(Note 1): When using the virtual axes, the I/O numbers allocated vary according to the number of virtual axes.

When selecting virtual 1st axis	The I/O number of "Axis 8 (virtual)" in the above table is allocated to "virtual 1st axis".
When selecting virtual 1st and 2nd axes	The I/O number of "Axis 7 (virtual)" in the above table is allocated to "virtual 1st axis". The I/O number of "Axis 8 (virtual)" in the above table is allocated to "virtual 2nd axis".

Contact allocation	Target axis	Name	Description	
WX124	X1240	Axis 1	Warning annunciation	Turns on when a warning occurs on the corresponding axis. The contacts of all axes turn on if all axes have warning. The details of the warning can be confirmed in the warning annunciation area of the positioning memory.
	X1241	Axis 2		
	X1242	Axis 3		
	X1243	Axis 4		
	X1244	Axis 5		
	X1245	Axis 6		
	X1246	Axis 7 (virtual)		
	X1247	Axis 8 (virtual)		
	X1248 -X124F	-		
WX125	X1250	Axis 1	RTEX general-purpose input 1	Monitor contact for the RTEX general-purpose input connected to the corresponding AMP. The input status of this contact does not affect on the operations of the motor and FP-XH M8N Control Unit.
	X1251		RTEX general-purpose input 2	
	X1252	Axis 2	RTEX general-purpose input 1	
	X1253		RTEX general-purpose input 2	
	X1254	Axis 3	RTEX general-purpose input 1	
	X1255		RTEX general-purpose input 2	
	X1256	Axis 4	RTEX general-purpose input 1	
	X1257		RTEX general-purpose input 2	
	X1258	Axis 5	RTEX general-purpose input 1	
	X1259		RTEX general-purpose input 2	
	X125A	Axis 6	RTEX general-purpose input 1	
	X125B		RTEX general-purpose input 2	
	X125C	Axis 7	RTEX general-purpose input 1	
	X125D		RTEX general-purpose input 2	
	X125E	Axis 8	RTEX general-purpose input 1	
	X125F		RTEX general-purpose input 2	
WX126	X1260 -X126F	-	-	-

(Note 1): When using the virtual axes, the I/O numbers allocated vary according to the number of virtual axes.

When selecting virtual 1st axis	The I/O number of "Axis 8 (virtual)" in the above table is allocated to "virtual 1st axis".
When selecting virtual 1st and 2nd axes	The I/O number of "Axis 7 (virtual)" in the above table is allocated to "virtual 1st axis". The I/O number of "Axis 8 (virtual)" in the above table is allocated to "virtual 2nd axis".

Contact allocation	Target axis	Name	Description	
WX127	X1270	Axis 1	Synchronous setting done	Changes synchronous settings in the unit with the synchronous setting request contact (Y1270 to Y1277) turned ON after changing the settings of synchronous control with the program. The contact turns ON upon completion of the setting changes. This contact turns OFF with the synchronous setting request contact (Y1270 to Y1277) turned OFF.
	X1271	Axis 2		
	X1272	Axis 3		
	X1273	Axis 4		
	X1274	Axis 5		
	X1275	Axis 6		
	X1276	Axis 7 (virtual)		
	X1277	Axis 8 (virtual)		
	X1278 -X127F	-		
WX128	X1280	Axis 1	Synchronous cancel active annunciation	Turns ON when the synchronous operation of the positioning unit is canceled with the synchronous setting cancel request contact (Y1280 to Y1287) turned ON. The synchronous operation axes cannot be executed if this contact is ON for the axes.
	X1281	Axis 2		
	X1282	Axis 3		
	X1283	Axis 4		
	X1284	Axis 5		
	X1285	Axis 6		
	X1286	Axis 7 (virtual)		
	X1287	Axis 8 (virtual)		
	X1288 -X128F	-		
WX129	X1290 -X129F	-	-	-
WX130	X1300 -X130F	-	-	-
WX131	X1310	Axis 1	Slave axis gear ratio change annunciation	Makes gear ratio changes with the slave axis gear ratio change request contact (Y1310 to Y1317). The contact for the corresponding axis turns ON after the gear ratio is changed.
	X1311	Axis 2		
	X1312	Axis 3		
	X1313	Axis 4		
	X1314	Axis 5		
	X1315	Axis 6		
	X1316	Axis 7 (virtual)		
	X1317	Axis 8 (virtual)		
	X1318 -X131F	-		

(Note 1): When using the virtual axes, the I/O numbers allocated vary according to the number of virtual axes.

When selecting virtual 1st axis	The I/O number of "Axis 8 (virtual)" in the above table is allocated to "virtual 1st axis".
When selecting virtual 1st and 2nd axes	The I/O number of "Axis 7 (virtual)" in the above table is allocated to "virtual 1st axis". The I/O number of "Axis 8 (virtual)" in the above table is allocated to "virtual 2nd axis".

Contact allocation		Target axis	Name	Description
WX132	X1320	-	-	-
	-X132F	-	-	-
WX133	X1330	Axis 1	Slave axis clutch operation annunciation	The clutch will start operating when the slave axis clutch ON request contact (Y1330 to Y1337) or clutch OFF request contact (Y1340 to Y1347) turns ON. The contact for the corresponding axis turns ON after the completion of the operation of the clutch.
	X1331	Axis 2		
	X1332	Axis 3		
	X1333	Axis 4		
	X1334	Axis 5		
	X1335	Axis 6		
	X1336	Axis 7 (virtual)		
	X1337	Axis 8 (virtual)		
WX134	X1340	-	-	-
	-X134F	-	-	-
WX135	X1350	-	-	-
	-X135F	-	-	-
WX136	X1360	-	-	-
	-X136F	-	-	-
WX137	X1370	-	-	-
	-X137F	-	-	-
WX138	X1380	Axis 1	Positioning speed change request reception annunciation	Starts the speed change operation when the positioning speed change request contact (Y1380 to Y1387) turns ON. The contact for the corresponding axis turns ON when the request is accepted.
	X1381	Axis 2		
	X1382	Axis 3		
	X1383	Axis 4		
	X1384	Axis 5		
	X1385	Axis 6		
	X1386	Axis 7 (virtual)		
	X1387	Axis 8 (virtual)		
WX138	X1388	-	-	-
	-X138F	-	-	-

(Note 1): When using the virtual axes, the I/O numbers allocated vary according to the number of virtual axes.

When selecting virtual 1st axis	The I/O number of "Axis 8 (virtual)" in the above table is allocated to "virtual 1st axis".
When selecting virtual 1st and 2nd axes	The I/O number of "Axis 7 (virtual)" in the above table is allocated to "virtual 1st axis". The I/O number of "Axis 8 (virtual)" in the above table is allocated to "virtual 2nd axis".

Contact allocation	Target axis	Name	Description	
WX139	X1390	Axis 1	Positioning movement amount change request reception Starts the movement amount change operation when the positioning movement amount change request contact (Y1390 to Y139F) turns ON. The contact for the corresponding axis turns ON when he request is accepted.	
	X1391	Axis 2		
	X1392	Axis 3		
	X1393	Axis 4		
	X1394	Axis 5		
	X1395	Axis 6		
	X1396	Axis 7 (virtual)		
	X1397	Axis 8 (virtual)		
	X1398 -X139F	-		-
WX140	X1400 -X140F	-	-	-
	WX141	X1410 -X141F	-	-

(Note 1): When using the virtual axes, the I/O numbers allocated vary according to the number of virtual axes.

When selecting virtual 1st axis	The I/O number of "Axis 8 (virtual)" in the above table is allocated to "virtual 1st axis".
When selecting virtual 1st and 2nd axes	The I/O number of "Axis 7 (virtual)" in the above table is allocated to "virtual 1st axis". The I/O number of "Axis 8 (virtual)" in the above table is allocated to "virtual 2nd axis".

Contact allocation	Target axis	Name	Description	
WY110	Y1100	All axes	System stop	Contact for requesting the system stop. When it turns on, all axes will stop at the deceleration time 0.
	Y1101	-	-	-
	Y1102	All axes	Cam table reading request	Turn ON this signal for reading cam tables. The cam table of a specified cam pattern number will be read when this signal turns ON. After the completion of the reading of cam tables, the cam table reading done contact (X1102) turns ON.
	Y1103	All axes	Cam table rewriting request	Turn ON this signal for reading cam tables. The cam table of a specified cam pattern number will be rewritten when this signal turns ON. After the completion of the rewriting cam tables, the cam table rewriting done contact (X1103) turns ON.
	Y1104	-	-	-
	Y1105	All axes	Axis group setting change request	This contact will turn ON after the axis group settings are changed.
	Y1106	-	-	-
	Y1107	All axes	Recalculation request	Turn on this signal when each positioning data (standard area) in the positioning memory was changed. The positioning data after the table number starting the recalculation specified in the positioning memory can be restructured and will be executable by turning on this signal. When restructuring of the positioning data completes, the recalculation done contact (X1107) turns on. Note) It is used only when the positioning data has been rewritten by ladder programs.
	Y1108 -Y110F	-	-	-
	WY111	Y111E -Y111F	-	-

Contact allocation	Target axis	Name	Description
WY112	Y1120	Axis 1	Requests the servo lock for the corresponding AMP. The servo lock is executed by the ON edge of this contact. The servo cannot be free automatically even in the program mode. To make the servo free, turn on the servo OFF request contacts (Y1130-Y1137). (The operation is the edge type.)
	Y1121	Axis 2	
	Y1122	Axis 3	
	Y1123	Axis 4	
	Y1124	Axis 5	
	Y1125	Axis 6	
	Y1126	Axis 7	
	Y1127	Axis 8	
	Y1128 -Y112F	-	-
WY113	Y1130	Axis 1	Requests the servo free for the corresponding AMP. The servo free is executed by the ON edge of this contact. (The operation is the edge type.)
	Y1131	Axis 2	
	Y1132	Axis 3	
	Y1133	Axis 4	
	Y1134	Axis 5	
	Y1135	Axis 6	
	Y1136	Axis 7	
	Y1137	Axis 8	
	Y1138 -Y113F	-	-
WY114	Y1140	Axis 1	Requests the positioning control of the corresponding axis. The starting table is specified in the area for specifying the position control starting table number in the positioning memory. (The operation is the edge type.) If this contact turns ON while the positioning unit is in tool operation, a warning will be output.
	Y1141	Axis 2	
	Y1142	Axis 3	
	Y1143	Axis 4	
	Y1144	Axis 5	
	Y1145	Axis 6	
	Y1146	Axis 7 (virtual)	
	Y1147	Axis 8 (virtual)	
	Y1148 -Y114F	-	-

(Note 1): When using the virtual axes, the I/O numbers allocated vary according to the number of virtual axes.

When selecting virtual 1st axis	The I/O number of "Axis 8 (virtual)" in the above table is allocated to "virtual 1st axis".
When selecting virtual 1st and 2nd axes	The I/O number of "Axis 7 (virtual)" in the above table is allocated to "virtual 1st axis". The I/O number of "Axis 8 (virtual)" in the above table is allocated to "virtual 2nd axis".

Contact allocation	Target axis	Name	Description	
WY115	Y1150	Axis 1	Home return start Requests the home return of the corresponding axis. (The operation is the edge type.) If this contact turns ON while the positioning unit is in tool operation, a warning will be output.	
	Y1151	Axis 2		
	Y1152	Axis 3		
	Y1153	Axis 4		
	Y1154	Axis 5		
	Y1155	Axis 6		
	Y1156	Axis 7 (virtual)		
	Y1157	Axis 8 (virtual)		
Y1158 -Y115F	-	-	-	
WY116	Y1160	Axis 1	Forward JOG	Requests the JOG operation of the corresponding axis. (The operation is the level type.) If this contact turns ON while the positioning unit is in tool operation, a warning will be output.
	Y1161		Reverse JOG	
	Y1162	Axis 2	Forward JOG	
	Y1163		Reverse JOG	
	Y1164	Axis 3	Forward JOG	
	Y1165		Reverse JOG	
	Y1166	Axis 4	Forward JOG	
	Y1167		Reverse JOG	
	Y1168	Axis 5	Forward JOG	
	Y1169		Reverse JOG	
	Y116A	Axis 6	Forward JOG	
	Y116B		Reverse JOG	
	Y116C	Axis 7 (virtual)	Forward JOG	
	Y116D		Reverse JOG	
Y116E	Axis 8 (virtual)	Forward JOG		
Y116F		Reverse JOG		
WY117	Y1170 -Y117F	-	-	-

(Note 1): When using the virtual axes, the I/O numbers allocated vary according to the number of virtual axes.

When selecting virtual 1st axis	The I/O number of "Axis 8 (virtual)" in the above table is allocated to "virtual 1st axis".
When selecting virtual 1st and 2nd axes	The I/O number of "Axis 7 (virtual)" in the above table is allocated to "virtual 1st axis". The I/O number of "Axis 8 (virtual)" in the above table is allocated to "virtual 2nd axis".

Contact allocation	Target axis	Name	Description
WY118	Y1180	Axis 1	Emergency stop Requests the emergency stop for the corresponding axes. (The operation is the level type.) Note) The deviation counter cannot be cleared.
	Y1181	Axis 2	
	Y1182	Axis 3	
	Y1183	Axis 4	
	Y1184	Axis 5	
	Y1185	Axis 6	
	Y1186	Axis 7 (virtual)	
	Y1187	Axis 8 (virtual)	
Y1188 -Y118F	-	-	-
WY119	Y1190	Axis 1	Deceleration stop Requests the deceleration stop for the corresponding axes. (The operation is the level type.) Note) The deviation counter cannot be cleared.
	Y1191	Axis 2	
	Y1192	Axis 3	
	Y1193	Axis 4	
	Y1194	Axis 5	
	Y1195	Axis 6	
	Y1196	Axis 7 (virtual)	
	Y1197	Axis 8 (virtual)	
Y1198 -Y119F	-	-	-
WY120	Y1200	Axis 1	Pulsar input enabled Requests the permission for the pulsar operation of the corresponding axis. (The operation is the level type.)
	Y1201	Axis 2	
	Y1202	Axis 3	
	Y1203	Axis 4	
	Y1204	Axis 5	
	Y1205	Axis 6	
	Y1206	Axis 7 (virtual)	
	Y1207	Axis 8 (virtual)	
Y1208 -Y120F	-	-	-

(Note 1): When using the virtual axes, the I/O numbers allocated vary according to the number of virtual axes.

When selecting virtual 1st axis	The I/O number of "Axis 8 (virtual)" in the above table is allocated to "virtual 1st axis".
When selecting virtual 1st and 2nd axes	The I/O number of "Axis 7 (virtual)" in the above table is allocated to "virtual 1st axis". The I/O number of "Axis 8 (virtual)" in the above table is allocated to "virtual 2nd axis".

Contact allocation	Target axis	Name	Description
WY121	Y1210	Axis 1	J-point speed change By turning ON this signal while the positioning unit is in J-point operation, the speed changes to the target speed in the specified acceleration/deceleration time and pattern. (The operation is the edge type.)
	Y1211	Axis 2	
	Y1212	Axis 3	
	Y1213	Axis 4	
	Y1214	Axis 5	
	Y1215	Axis 6	
	Y1216	Axis 7 (virtual)	
	Y1217	Axis 8 (virtual)	
	Y1218 -Y121F	-	
WY122	Y1220	Axis 1	J-point positioning start The positioning unit will go to the next table processing when this signal turns ON during the JOG (J-point) positioning of the corresponding axis. (The operation is the edge type.)
	Y1221	Axis 2	
	Y1222	Axis 3	
	Y1223	Axis 4	
	Y1224	Axis 5	
	Y1225	Axis 6	
	Y1226	Axis 7 (virtual)	
	Y1227	Axis 8 (virtual)	
	Y1228 -Y122F	-	
WY123	Y1230	Axis 1	Error clear request Requests the error clear of the corresponding axis. The processing to recover from errors is performed and the error logs are cleared by turning on this signal. Note) Unrecoverable errors cannot be recovered even if this signal turned on.
	Y1231	Axis 2	
	Y1232	Axis 3	
	Y1233	Axis 4	
	Y1234	Axis 5	
	Y1235	Axis 6	
	Y1236	Axis 7 (virtual)	
	Y1237	Axis 8 (virtual)	
	Y1238 -Y123F	-	

(Note 1): When using the virtual axes, the I/O numbers allocated vary according to the number of virtual axes.

When selecting virtual 1st axis	The I/O number of "Axis 8 (virtual)" in the above table is allocated to "virtual 1st axis".
When selecting virtual 1st and 2nd axes	The I/O number of "Axis 7 (virtual)" in the above table is allocated to "virtual 1st axis". The I/O number of "Axis 8 (virtual)" in the above table is allocated to "virtual 2nd axis".

Contact allocation	Target axis	Name	Description	
WY124	Y1240	Axis 1	Warning clear request Requests the warning clear of the corresponding axis. The warning logs are cleared by turning on this signal.	
	Y1241	Axis 2		
	Y1242	Axis 3		
	Y1243	Axis 4		
	Y1244	Axis 5		
	Y1245	Axis 6		
	Y1246	Axis 7 (virtual)		
	Y1247	Axis 8 (virtual)		
Y1248 -Y124F	-	-	-	
WY125	Y1250	Axis 1	RTEX general-purpose output 1	Contact for the RTEX general-purpose output connected to the corresponding AMP. The input status of this contact does not affect on the operation of the motor and unit.
	Y1251		RTEX general-purpose output 2	
	Y1252	Axis 2	RTEX general-purpose output 1	
	Y1253		RTEX general-purpose output 2	
	Y1254	Axis 3	RTEX general-purpose output 1	
	Y1255		RTEX general-purpose output 2	
	Y1256	Axis 4	RTEX general-purpose output 1	
	Y1257		RTEX general-purpose output 2	
	Y1258	Axis 5	RTEX general-purpose output 1	
	Y1259		RTEX general-purpose output 2	
	Y125A	Axis 6	RTEX general-purpose output 1	
	Y125B		RTEX general-purpose output 2	
	Y125C	Axis 7	RTEX general-purpose output 1	
	Y125D		RTEX general-purpose output 2	
	Y125E	Axis 8	RTEX general-purpose output 1	
	Y125F		RTEX general-purpose output 2	
WY126	Y1260 -Y126F	-	-	-

(Note 1): When using the virtual axes, the I/O numbers allocated vary according to the number of virtual axes.

When selecting virtual 1st axis	The I/O number of "Axis 8 (virtual)" in the above table is allocated to "virtual 1st axis".
When selecting virtual 1st and 2nd axes	The I/O number of "Axis 7 (virtual)" in the above table is allocated to "virtual 1st axis". The I/O number of "Axis 8 (virtual)" in the above table is allocated to "virtual 2nd axis".

Contact allocation	Target axis	Name	Description	
WY127	Y1270	Axis 1	Synchronous setting request This contact will turn ON after the synchronous operation settings are changed. Turn ON this contact for reflecting the setting changes in the synchronous control common area of the positioning memory. This flag is an edge trigger.	
	Y1271	Axis 2		
	Y1272	Axis 3		
	Y1273	Axis 4		
	Y1274	Axis 5		
	Y1275	Axis 6		
	Y1276	Axis 7 (virtual)		
	Y1277	Axis 8 (virtual)		
	Y1278 -Y127F	-		-
WY128	Y1280	Axis 1	Synchronous cancel request Turns ON the contact for the axis to cancel the synchronous operation. The unit will not perform the synchronous operation of the axis for which this contact is ON. Turn ON this contact for canceling the synchronous state temporarily during synchronous control. To make the synchronous state, turn OFF this contact.	
	Y1281	Axis 2		
	Y1282	Axis 3		
	Y1283	Axis 4		
	Y1284	Axis 5		
	Y1285	Axis 6		
	Y1286	Axis 7 (virtual)		
	Y1287	Axis 8 (virtual)		
	Y1288 -Y128F	-		-
WY129	Y1290 -Y129F	-	-	-
WY130	Y1300 -Y130F	-	-	-
WY131	Y1310	Axis 1	Slave axis gear ratio change request A gear ratio change is made with the contact for the corresponding axis turned ON while the positioning unit is in synchronous operation. (The operation is the edge type.)	
	Y1311	Axis 2		
	Y1312	Axis 3		
	Y1313	Axis 4		
	Y1314	Axis 5		
	Y1315	Axis 6		
	Y1316	Axis 7 (virtual)		
	Y1317	Axis 8 (virtual)		
	Y1318 -Y131F	-		-
WY132	Y1320 -Y132F	-	-	-

(Note 1): When using the virtual axes, the I/O numbers allocated vary according to the number of virtual axes.

When selecting virtual 1st axis	The I/O number of "Axis 8 (virtual)" in the above table is allocated to "virtual 1st axis".
When selecting virtual 1st and 2nd axes	The I/O number of "Axis 7 (virtual)" in the above table is allocated to "virtual 1st axis". The I/O number of "Axis 8 (virtual)" in the above table is allocated to "virtual 2nd axis".

Contact allocation	Target axis	Name	Description	
WY133	Y1330	Axis 1	Slave axis clutch ON request Starts the clutch ON operation when the contact for the corresponding axis during the synchronous operation turns on. No axes start unless the clutch is used. (Set the operation to level type, rising edge, or falling edge.)	
	Y1331	Axis 2		
	Y1332	Axis 3		
	Y1333	Axis 4		
	Y1334	Axis 5		
	Y1335	Axis 6		
	Y1336	Axis 7 (virtual)		
	Y1337	Axis 8 (virtual)		
	Y1338 -Y133F	-		-
WY134	Y1340	Axis 1	Slave axis clutch OFF request Starts the clutch OFF operation when the contact for the corresponding axis during the synchronous operation turns on. No axes start unless the clutch is used. (Set the operation to rising edge, or falling edge.) These signals will be disabled while the slave axis clutch ON request signal is set to level type.	
	Y1341	Axis 2		
	Y1342	Axis 3		
	Y1343	Axis 4		
	Y1344	Axis 5		
	Y1345	Axis 6		
	Y1346	Axis 7 (virtual)		
	Y1347	Axis 8 (virtual)		
	Y1348 -Y134F	-		-
WY135	Y1350 -Y135F	-	-	-
	Y1360 -Y136F	-	-	-
WY137	Y1370 -Y137F	-	-	-

(Note 1): When using the virtual axes, the I/O numbers allocated vary according to the number of virtual axes.

When selecting virtual 1st axis	The I/O number of "Axis 8 (virtual)" in the above table is allocated to "virtual 1st axis".
When selecting virtual 1st and 2nd axes	The I/O number of "Axis 7 (virtual)" in the above table is allocated to "virtual 1st axis". The I/O number of "Axis 8 (virtual)" in the above table is allocated to "virtual 2nd axis".

Contact allocation	Target axis	Name	Description	
WY138	Y1380	Axis 1	Positioning speed change request	Changes the target speed by turning on the contact for the corresponding axis during the positioning operation. (The operation is the edge type.)
	Y1381	Axis 2		
	Y1382	Axis 3		
	Y1383	Axis 4		
	Y1384	Axis 5		
	Y1385	Axis 6		
	Y1386	Axis 7 (virtual)		
	Y1387	Axis 8 (virtual)		
Y1388 -Y138F	-	-	-	
WY139	Y1390	Axis 1	Positioning movement amount change request	Changes the target movement amount by turning on the contact for the corresponding axis during the positioning operation. (The operation is the edge type.)
	Y1391	Axis 2		
	Y1392	Axis 3		
	Y1393	Axis 4		
	Y1394	Axis 5		
	Y1395	Axis 6		
	Y1396	Axis 7 (virtual)		
	Y1397	Axis 8 (virtual)		
	Y1398 -Y139F	-		
WY140	Y1400 -Y140F	-	-	-
WY141	Y1410 -Y141F	-	-	-

(Note 1): When using the virtual axes, the I/O numbers allocated vary according to the number of virtual axes.

When selecting virtual 1st axis	The I/O number of "Axis 8 (virtual)" in the above table is allocated to "virtual 1st axis".
When selecting virtual 1st and 2nd axes	The I/O number of "Axis 7 (virtual)" in the above table is allocated to "virtual 1st axis". The I/O number of "Axis 8 (virtual)" in the above table is allocated to "virtual 2nd axis".

4

Installation

4.1 Installation

4.1.1 Installation Environment and Space

■ Installation environment

Use the unit within the range of the general specifications when installing.

- Surrounding air temperature: 0 to +55 °C
- Surrounding air humidity: 10-95%RH (non-condensing at 25 °C)
- Pollution degree: 2
- Operating altitude: 2000 m above the sea level or lower
- Overvoltage category: II or less
- Site of installation: within control cabinets with the protection level of over IP54 (metal materials with enough toughness)

It can be used in the above environments.

Do not use it in the following environments.

- Direct sunlight
- Sudden temperature changes causing condensation
- Inflammable or corrosive gas.
- Excessive airborne dust, metal particles or saline matter.
- Benzene, paint thinner, alcohol or other organic solvents or strong alkaline solutions such as ammonia or caustic soda.
- Direct vibration, shock or direct drop of water.
- Influence from power transmission lines, high voltage equipment, power cables, power equipment, radio transmitters, or any other equipment that would generate high switching surges. (Min.100mm or less)

■ Static electricity

- Before touching the unit, always touch a grounded piece of metal in order to discharge static electricity.
- Do not directly touch the connector pins.

■ Heat dissipation considerations

- In order to facilitate heat dissipation, set the LED display section on the left side.

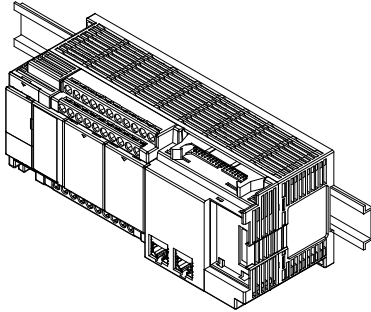

- Vertical, horizontal or upside down installation are prohibited because they will result in insufficient heat dissipation, leading to abnormal internal heat.
- Do not install directly above the heater, transformer, large capacity resistance and other equipment with large heat radiation.

■ Installation space

- Leave at least 50mm of space between the wiring ducts of the unit and other devices to allow heat radiation and unit replacement.
- To avoid being affected by the radiation, the surface of each unit and the power line or electromagnetic switches should be separated by 100 mm or more when installing. Make sure it separated with other devices by a certain distance, especially when it is installed on the back side of the control cabinet.
- Please ensure space for the cable connecting to the programming tool.

4.2 Backup Battery Installation

4.2.1 Backup Battery Installation

- Please install the backup battery according to the following steps.

■ Installation steps



◆ PROCEDURE

1. Open the operating unit cover and battery cover.
2. Insert the backup battery into the battery holder.
3. Connect the battery connector.
4. Close the operating unit cover and battery cover.

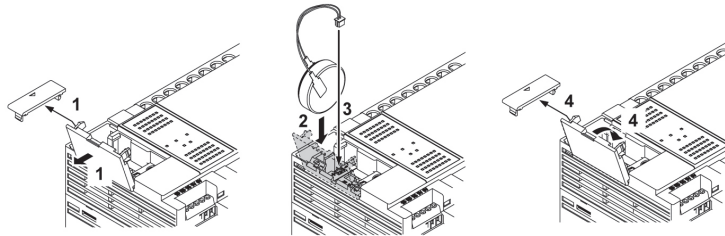

- When removing the backup battery, push the push rod portion.

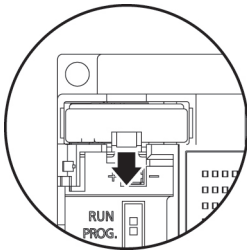

◆ KEY POINTS

- Backup battery is used for clock/calendar function and the expansion of the backup area of the operation memory.
- As for the role of the backup battery, its battery life and setup of memory area, please refer to 21.1 Memory Backup.

4.3 Add-on cassette Installation

4.3.1 Precautions for Installing Add-on cassettes

- Use the supplied screws to fix the add-on cassette on the control unit.
- The screw tightening torque is 0.3 - 0.5 N · m, please fasten it securely.

■ Recommended screws

Type	Input	Number
Self-tapping screw	Material: SW coil (+) P fasten 2.6-16 Zinc plated, trivalent chromate (black)	2/1 cassette



◆ NOTES

- **Make sure to turn off the power to install. Installing with the control unit is powered ON will cause failure.**
- **Do not touch the back of the add-on cassette and connector. Otherwise, IC may be damaged due to static electricity.**

4.3.2 Communications Cassette Installation

The communication cassette can be installed on the control unit or function cassette.

■ Mounted on the control unit

- Connect the connector on the back of the communication cassette and the connector of the control unit cassette installation part, fix the communication cassette with screws at the bottom left and upper right.
- If the flange is retained, there shouldn't be any problem. AFPX-COM5 does not have flange.

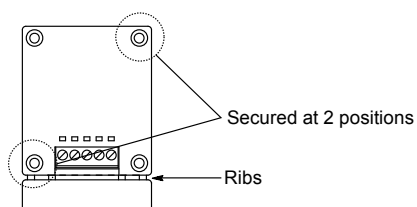
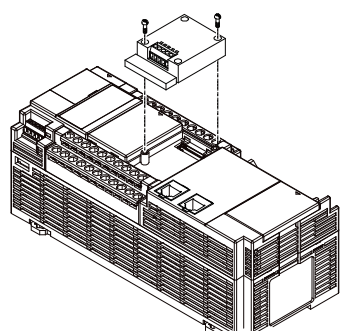

■ **Mounted on the function cassette**

- Connect the connector on the back of the function cassette and the connector of the control unit cassette installation part, fix the function cassette with screws at the bottom left and upper right.

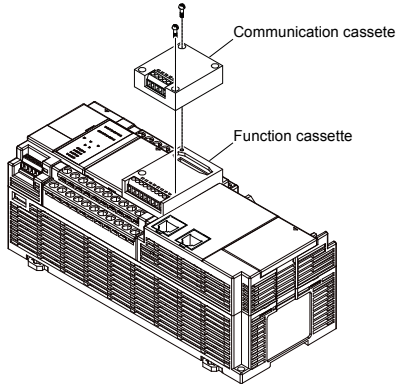

Function card

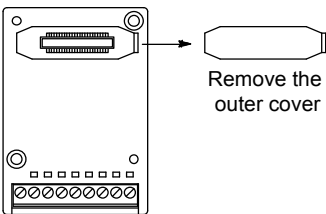

Communication card

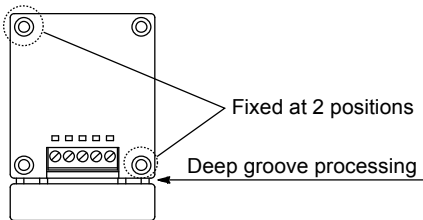

4.3.3 Function Cassette Installation

The communication cassette can be installed on the control unit.

■ **Mounted on the control unit**

- Connect the connector on the back of the function cassette and the connector of the control unit cassette installation part, fix the function cassette with screws at the bottom left and upper right.

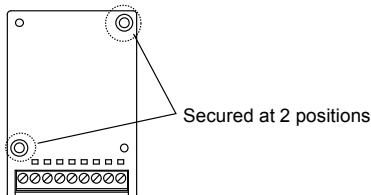
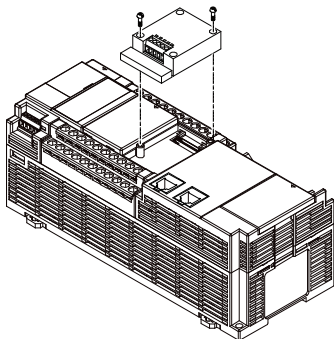

4.4 Connecting FP-X Expansion Unit

4.4.1 Setup of Terminal Setting Switches

- Set all terminal setting DIP switches of the expansion unit to ON.
Set all terminal setting DIP switches of the expansion unit to OFF.

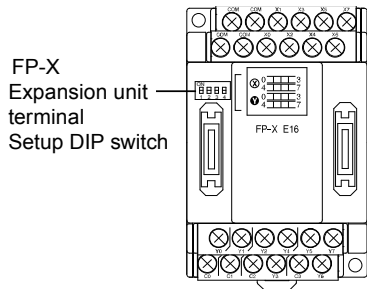

4.4.2 Confirmation of FP-X Expansion Cables

- FP-X expansion units and FP-X expansion FP0 adapters are connected to the control unit via a dedicated expansion cable.
- FP-X expansion units and FP-X expansion FP0 adapters come with an 8 cm type expansion cable (AFPX-EC08).
- When setting the unit on the upper and lower part, a long expansion cable must be used, please order 30 cm type (AFPX-EC30) or 80 cm type (AFPX-EC80) separately.



NOTES

- Please limit the total length of the expansion cable to less than 160 cm when using.
- Please try to keep the expansion cable (AFPX-EC30, EC80) away from interfering devices and wires.

4.4.3 Connecting FP-X expansion unit

Please connect FP-X expansion unit in accordance with the following procedure.

■ Installation steps



◆ PROCEDURE

1. Remove the control unit, the expansion unit expansion cover.
2. Install an expansion connector cable on the control unit expansion connector portion and expansion I/O unit expansion connector portion (left).

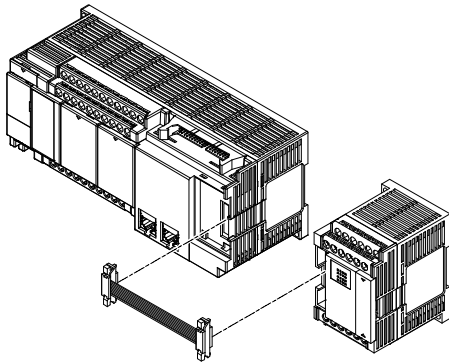

3. Units should be close together to ensure that the expansion cable is housed between the units.

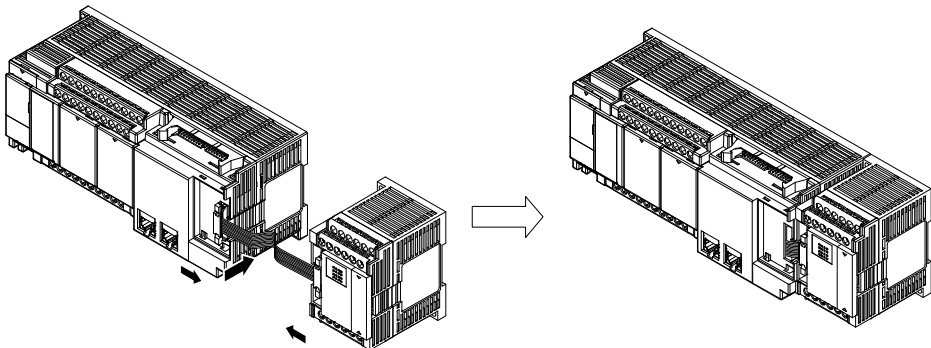

4. Install expansion cover.

4.5 Connecting FP0 Expansion Unit

4.5.1 Connecting FP0 Expansion Unit

- FP0 expansion units (expansion unit, high function unit) shall expand on the right side of FP-X expansion FP0 adapters.
- When the unit is expanded, use the FP0 right connector for expansion and the expansion hook on the side of the unit.

■ Installation steps



◆ PROCEDURE

1. Please use a screwdriver to move the expansion hook.
2. Install after the lug bosses on the expanded unit side are aligned.

Please make the connector tightly fitted to eliminate the gap between the units.

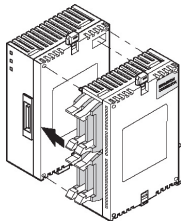

3. Please lift the expansion hook according to step 1 to fix the unit.

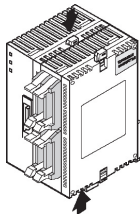

4.5.2 Connecting FP-X Expansion FP0 Adapter

Please connect FP-X expansion unit in accordance with the following procedure.

■ Installation steps



◆ PROCEDURE

1. Remove the control unit, the expansion unit expansion cover.
2. Install an expansion connector cable on the control unit expansion connector portion and FP-X expansion FP0 adapter expansion connector portion (left).

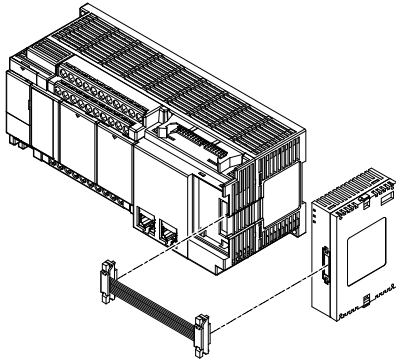

3. Units should be close together to ensure that the expansion cable is housed between the units.

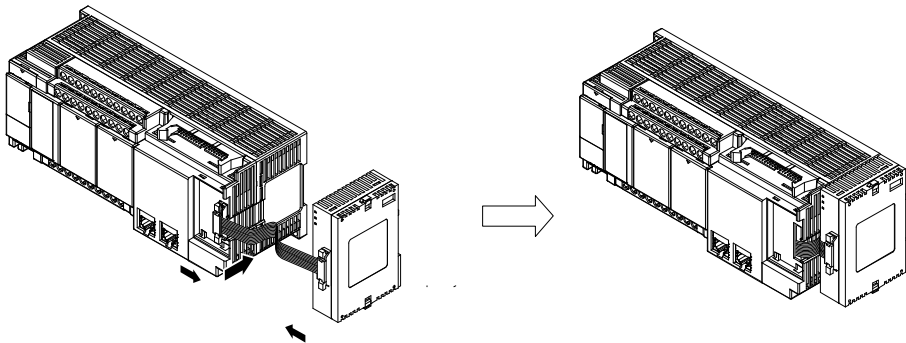

4. Install expansion cover.



◆ KEY POINTS

- The expansion FP0 adapter has no terminal setting switch, but the terminal is set inside it. Set the terminal setting switch of other expansion units to OFF.

4.6 Installation

4.6.1 Installation and Removal for DIN Rail

■ Installation steps



◆ PROCEDURE

1. Pull out all DIN rail mounting stems on the back of the unit from underside.
2. Embed the upper part of the unit installing part into the DIN rail.
3. Embed the lower part of the unit installing part into the DIN rail while pushing the unit installing part into the DIN rail.
4. Push up the DIN rail mounting stem on the back of the unit and lock until you hear a "click" sound.

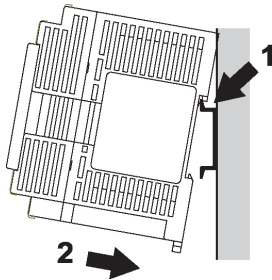

■ Removal steps



◆ PROCEDURE

1. Pull out all DIN rail mounting stems on the back of the unit from underside.
2. Pull the lower side of the unit toward you.
3. Remove it from the DIN rail while lifting the unit.

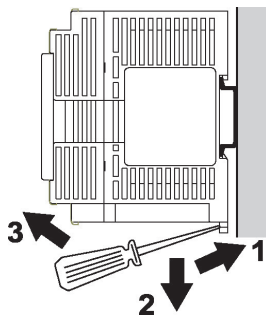

4.6.2 Mounting with Screws

Please use M4 screws for mounting.



◆ REFERENCE

For installation dimensions, refer to "26.9.2 Installation Dimensions".

5

Wiring of Power Supply and General-purpose I/O Parts

5.1 Terminal Arrangement

5.1.1 Power Supply and General-purpose I/O Parts

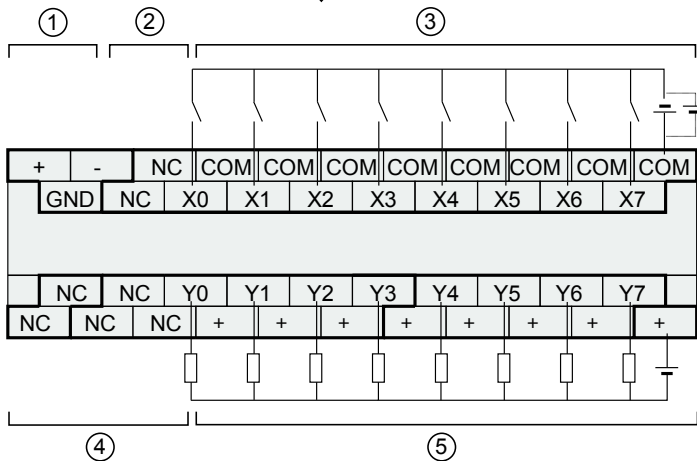
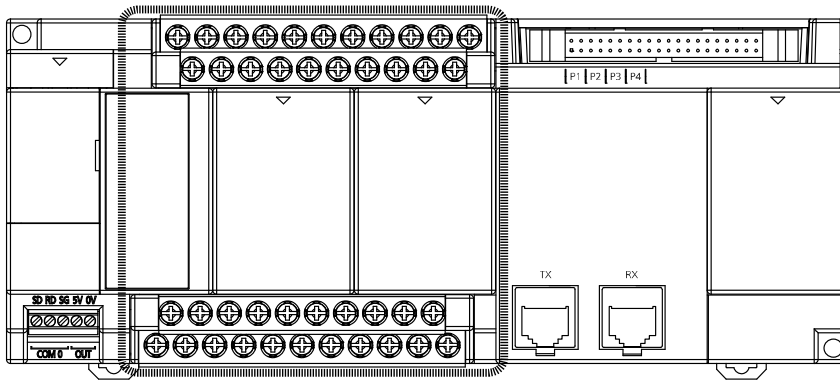

No.	Name	Description
①	AC power supply terminal (input)	
②	Unused	No connection is allowed.
③	Input terminal	All COM terminals of the input side are connected internally.
④	Unused	No connection is allowed.
⑤	Output terminal	All (+) terminals of the input side are connected internally.

5.2 Wiring of Power Supply

5.2.1 General Precautions

■ Power supply selection

- Please use a power supply with less interference whenever possible.
- Although overlap in the power line interference has sufficient interference tolerance, but we still recommend using the insulated transformer / insulated power supply for further interference attenuation.

■ Isolation of power supply systems

Please separate wires for the unit, input and output device, and power equipment.

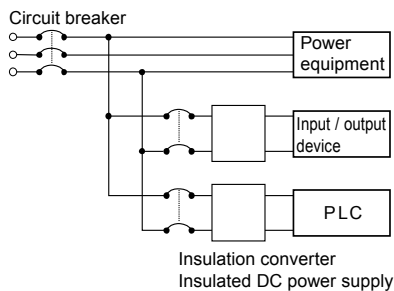

■ Power sequence

- Take the power sequence into consideration and cut off the PLC power supply before the power supply for input and output is shut off.
- If the input and output power is shut off before cutting off the PLC power supply, the control unit may sometimes detect the change of the input value and cause an unexpected sequence of actions.

5.2.2 Grounding

- To obtain adequate anti-interference performance, please make sure the power supply is grounded.
- Grounding location shall be as close as possible to the PLC to shorten the length of the grounding wire.
- When used in common with other devices, it can sometimes lead to an opposite effect, so dedicated grounding must be used.

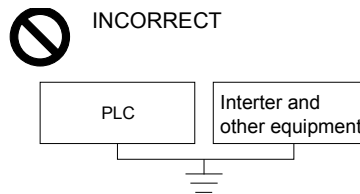
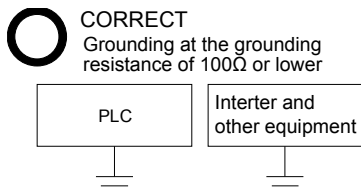

5.2.3 Power Supply of Control Unit / Expansion Unit

■ Power wiring (FP-XH M8N16PD control unit)

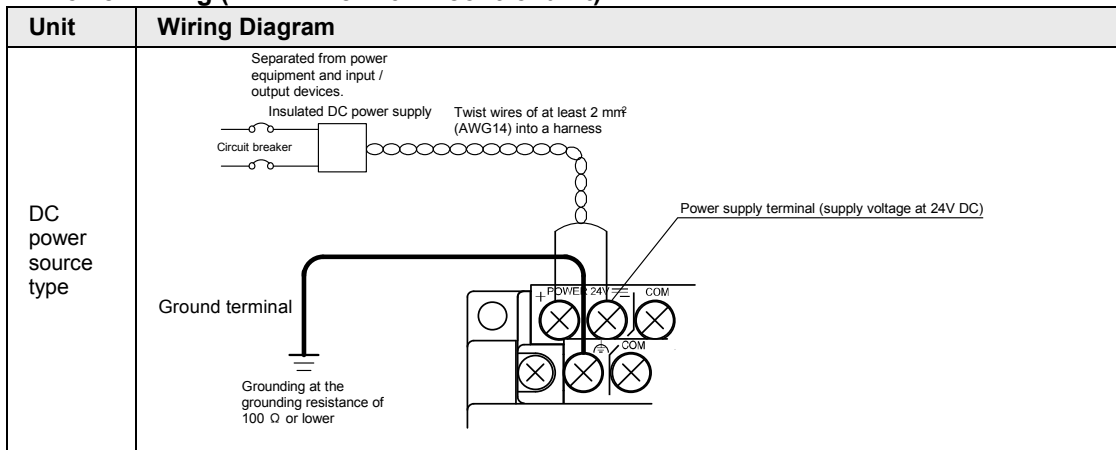

■ Supply voltage

Please confirm that the voltage of the power supply to be connected is within the allowed range.

Model	Rated input voltage	Allowable voltage range	Rated frequency	Allowable frequency range
DC Power Supply Type	24 VDC	21.6 – 26.4 VDC	—	—

■ Power supply cables

- To reduce the voltage drop, use a wire that is at least 2 mm² (AWG14).
- To reduce the influence of interference, the power cable shall be stranded (strand processing).

■ Applicable wires

Applicable wires	Tightening torque
AWG22-14 (0.3 mm ² -2.0 mm ²)	0.5 - 0.6 N m

■ Applicable crimp terminals

M3 terminal screws are used for the terminals. Please use the following crimp terminals to connect terminals.

Fork type terminal

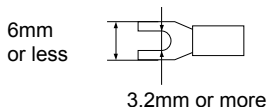

Ring type terminal

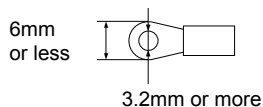

■ Applicable crimp terminals

Shape	Model	Applicable wires
Round	2-MS3	1.04-2.63 mm ²
Fork type	2-N3A	

(Note) Use a wire that is at least 2 mm².



NOTE

- If the voltage or frequency of the power supply exceeds the allowable range, or a wire outside the specified range is used, the power unit of the PLC may fail.

5.2.4 Power Supply of FP-X Expansion FP0 Adapter / FP0 Expansion Unit

■ Power wiring (FP-X expansion FP0 adapter / FP0 expansion unit)

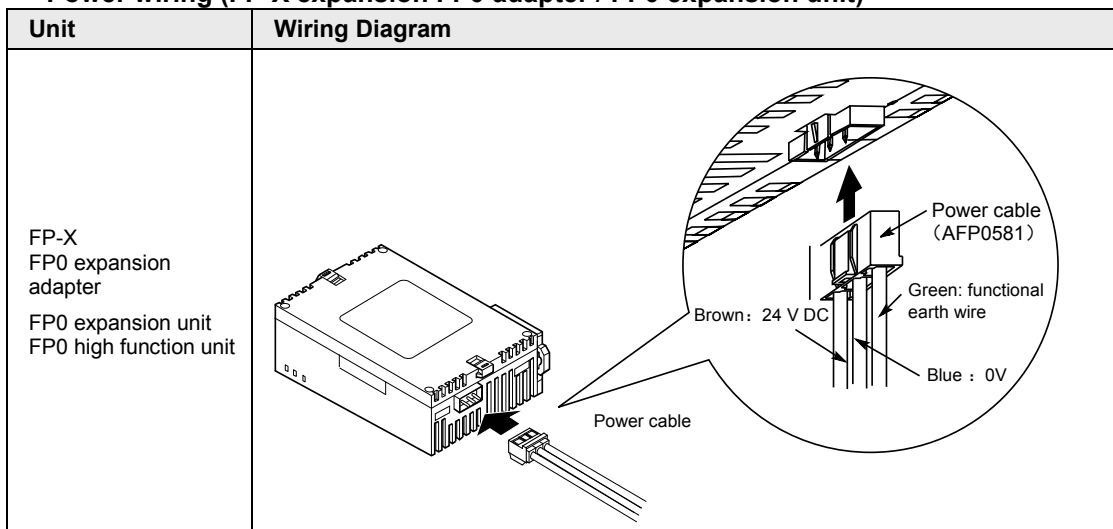

■ About power supply selection

- To prevent against the abnormal voltage from the power line, use a insulated power with built-in protection circuit (reinforced insulation or double insulation wire).
- The built-in regulator of the unit uses a non-insulated type.
- In order to simultaneously start the power supply, the power of the expansion FP0 adapter shall be supplied by a service power supply for FP-XH control unit input.

■ Supply voltage

- Please confirm that the voltage of the power supply to be connected is within the allowed range.

Rated input voltage	Allowable voltage range
24 VDC	20.4 - 28.8 VDC

■ Power supply cables

- Use the supplied power cable (model: AFP0581) to connect the power supply.
Brown: 24 VDC Blue: 0 V Green: functional earth wire
- To reduce the influence of interference, the power cable shall be stranded (strand processing).

■ Power sequence

- In order to effectively and easily achieve the expansion FP0 adapter power sequence, the power of the expansion FP0 adapter shall be supplied by a service power supply for FP-XH M8N control unit input.
- Power on the FP0 expansion unit before turning on the FP-XH M8N system power.
- Note the power sequence, the power of the FP-XH M8N system and the FP0 expansion unit shall be turned off before the input and output power is switched off. If the input and output power is shut off first, the control unit may sometimes detect the change of the input value and cause an unexpected sequence of actions.

Operation	Power sequence
ON	FP0 power → FP-XH M8N power, expansion FP0 adapter → input and output power
OFF	FP-XH M8N power, expansion FP0 adapter → FP0 power → input and output power

■ Grounding of the FP-X expansion FP0 adapter and FP0 expansion unit

- The functional grounding wire (green) of the included cable shall be grounded. Depending on the different service environments, sometimes there will be problems if grounded.
- The power line of the FP-X expansion FP0 adapter connects to the functional grounding through a varistor. The varistor may be shorted when there is an abnormal potential between the power line and the ground.

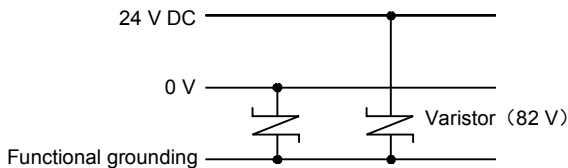

Extended FP0 adapter power circuit

5.3 Wiring of Input and Output

5.3.1 Precautions Regarding Input and Output Wirings

■ Wiring location

The input wire, output wire and power line shall be separated from each other, try to keep their distance when wiring. Do not put them in the same conduit or tie them up. The input wire, output wire, power line and high-voltage line shall be separated by at least 100 mm.

■ Wire selection

When wiring the input line and output line, select the wire diameter according to the current capacity.

■ Power supply

Switch off the PLC power supply before wiring. The control units, expansion units and all cassettes shall be connected with the power supply switched off. If you make the connection with the power supply switched on, a failure or malfunction may occur.

5.3.2 Input Wiring

■ Connection with photoelectric sensors and proximity sensors

Relay Output Type

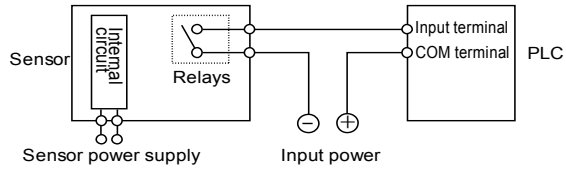

NPN Open Collector Output Type

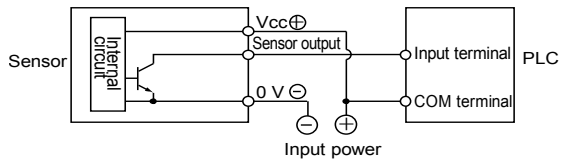

Voltage Output Type

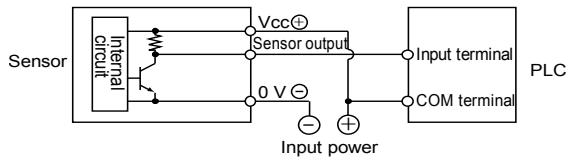

Two-Wire Output Type

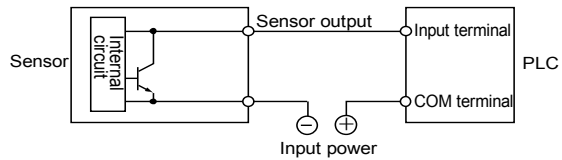

■ **Precautions when using a reed switch with LED**

If the LED is connected in series to the input contacts (such as a reed switch with LED, etc.), apply a voltage greater than the ON voltage to the input terminal of the PLC. Please pay special attention when several switches are connected in series.

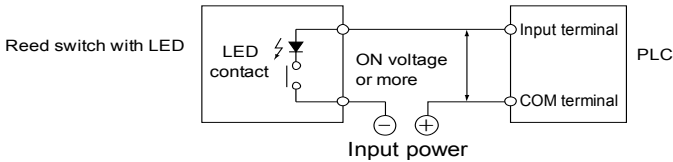

■ **Precautions when using a two-wire sensor**

When using a two-wire photoelectric sensor or proximity sensor, if cutting off the input current flowing to PLC is not possible due to the leakage current, connect the bleeder resistor as shown in the left chart.

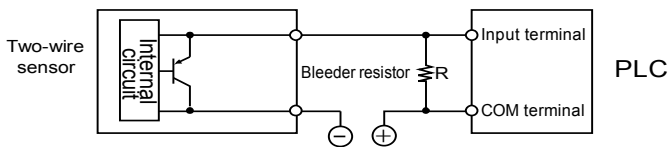

■ **Precautions when using a limit switch with LED**

When using a limit switch with LED, if cutting off the input current flowing to PLC is not possible due to the leakage current, connect the bleeder resistor as shown in the left chart.

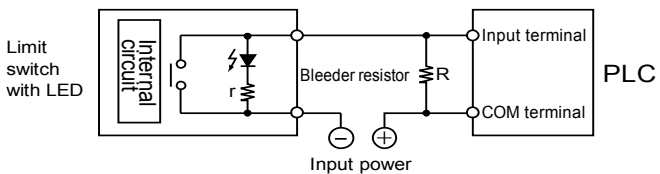

5.3.3 Output Wiring

■ Protection circuit of the inductive load

For inductive load, please install a protection circuit parallel with the load. When the DC inductive load is switched on/off, the protection circuit has a great positive influence on the service life, particularly for the relay output type. Therefore, make sure the diode is connected at both ends of the load.

For AC load

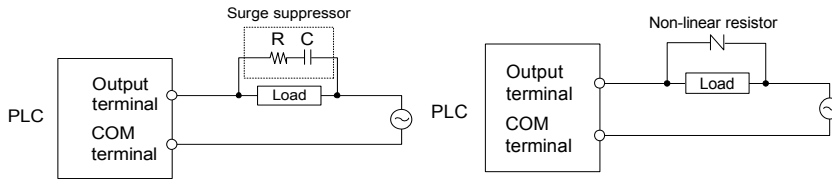

Example of surge suppressor Resistance at 50Ω
Capacity 0.47 μF

For DC load

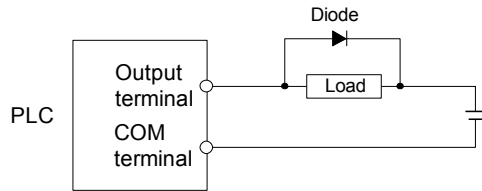

Diode Reverse voltage Higher than 3 times the rated load voltage
Average rectified current Greater than the load current

■ Precautions on using capacitive loads

When connecting a load with a large impact current, please set up the protection circuit as the following figure to minimize its impact.

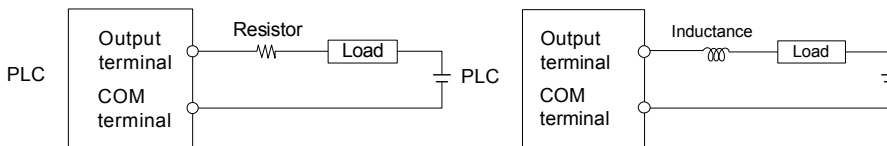

5.4 Wiring of Terminal Block

5.4.1 Suitable Wires

■ Suitable wires

Applicable wires	Tightening torque
AWG22-14 (0.3 mm ² -2.0 mm ²)	0.5 - 0.6 N · m

■ Supplied terminal block

- M3 terminal screws are used for the terminals. Please use the following crimp terminals to connect terminals.
- When using round terminals, remove the terminal block cover before operating.

Fork type terminal

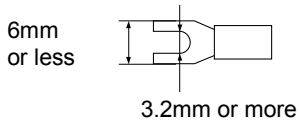

Ring type terminal

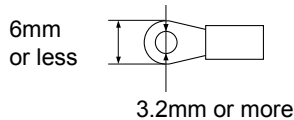

5.4.2 Terminal Block Cover

- When using round terminals, remove the terminal block cover before operating.

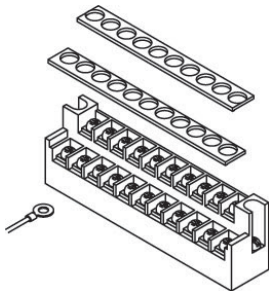

◆ NOTE

- To prevent electric shock, make sure to install the terminal block outer cover as is after wiring.

5.4.3 Installation and Removal of Terminal Block

The terminal block is screw-fixed and can be installed and removed.

■ Removal of the terminal block

Loosen the 2 mounting screws to remove the terminal block. The screws are fixed on the terminal block, they cannot be removed.

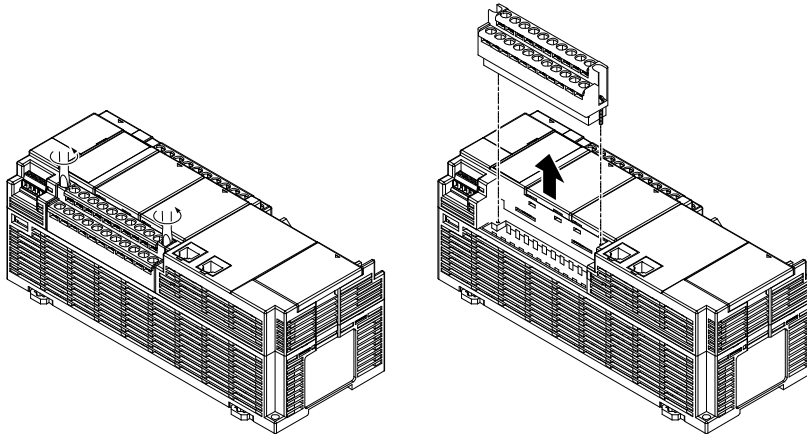

■ Installation of the terminal block

- Tighten the screws when the terminal block is lifted up. After tightening the screws, the terminal box is fixed.
- Please set tightening torque to $0.25 - 0.35\text{N} \cdot \text{m}$.

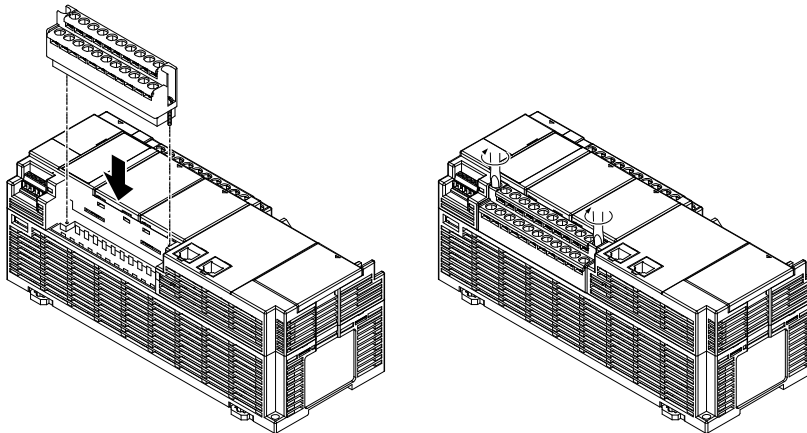

5.5 Safety Measures

5.5.1 Safety Measures

■ Precautions regarding system design

In certain applications, malfunction may occur for the following reasons:

- Power on timing differences between the PLC system and input/output or mechanical power apparatus.
- Response time lag when a momentary power drop occurs.
- Abnormality in the PLC unit, external power supply, or other devices.

In order to prevent a malfunction resulting in system shutdown choose the adequate safety measures listed in the following:

■ Interlock circuit

When a motor clockwise/counter-clockwise operation is controlled, provide an interlock circuit externally.

■ Emergency stop circuit

Provide an emergency stop circuit to the PLC externally to turn off the power supply of the output device.

■ Start up sequence

The PLC should be operated after all of the outside devices are energized. To keep this sequence, the following measures are recommended:

- Turn on the PLC with the mode selector set to the PROG. mode, and then switch to the RUN mode.
- Program the PLC so as to disregard the inputs and outputs until the outside devices are energized.

Note) In case of stopping the operation of the PLC also, have the input/output devices turned off after the PLC has stopped operating.

■ Grounding

When installing the PLC next to devices that generate high voltages from switching, such as inverters, do not ground them together. Use an exclusive ground for each device which should be grounded at a grounding resistance of 100Ω or less.

■ Electric shock prevention

The terminal block cover must be used for preventing electric shock.

5.5.2 Momentary Power Failures

■ Operation of momentary power failures

- - If the duration of the power failure is less than 10 ms, the FP-XH M8N control unit continues to operate. If the power is off for 10 ms or longer, operation changes depending on the combination of units, the power supply voltage, and other factors. (In some cases, operation may be the same as that for a power supply reset.)
- - Although the duration of the power failure for the expansion FP0 adapter is 10 ms, judge the permissible time for the system after confirming the permissible duration of the power failure for the DC power supply that supplies power to the expansion FP0 adapter. (Supply the power to it from the service power supply for the input of the FP-XH M8N control unit.)
- - When using the expansion unit with a built-in power supply (E30, expansion FP0 adapter), depending on the duration of the momentary power failure, either one unit may be without electricity momentarily and the I/O verify error may occur. In that case, turn off the power supply and then turn on again.

5.5.3 Watchdog Timer

- The watchdog timer detects abnormal program or hardware.
- When using the FP-XH M8N control unit, it is set to 640 ms.
- The ERR.LED at the front of the controller unit lights up after the watchdog timer is operated. At this time, the output of all output units turned to OFF and brought to a standstill.

6

Wiring of Motion I/O Parts

6.1 Terminal Layout Diagram

The motion I/O part has two interfaces.

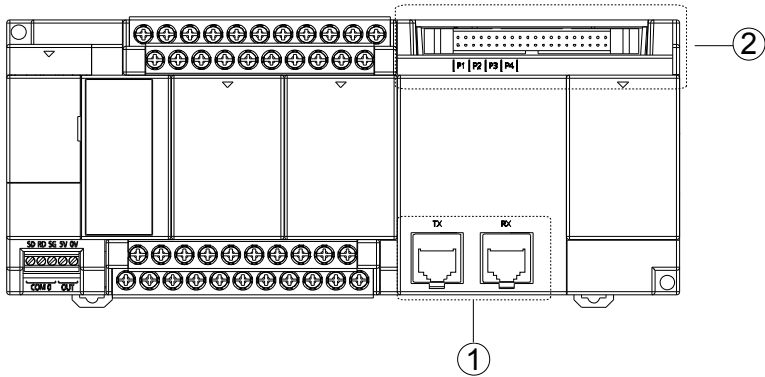

No.	Name	Description
①	Network (RTEX) connector	RJ45 connector x 2 Perform the loop connection via the servo amplifier and RTEX network.
②	Pulse input connector	Input of four channels are available. Encoders and pulsars can be connected.

6.2 Settings on Servo Amplifier

6.2.1 Checking Rotary Switches

- When using the FP-XH M8N Control Unit in combination with the servo amplifier A6N/A5N, the node address of the RTEXT network is set with the rotary switches on the front side of the servo amplifier.
- The numbers (01-08) set with the switches correspond to the axis numbers (1-8) controlled by the FP-XH M8N Control Unit.

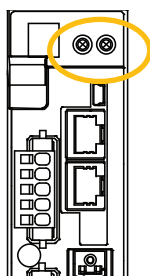

■ Switch setting

Setting value	Front panel		Function
	Tens place of the left switch	One place of the right switch	
0-31	0-3	0-9	Set numbers in decimal. Range: 01-08



◆ KEY POINTS

- The node address of the RTEXT network is determined by the setting of the rotary switches regardless of the connection order.
- In the following cases, errors occur.

Error code	State
2020	The same unit number exists in the same network.
2030	A unit number is set to 0.
2030	A unit number larger than the maximum axis number of the unit used was specified.
2010	An amplifier exceeding the usable maximum number of axes is connected

- For the setting state of the rotary switches, the values when the power turns on are valid. For changing the setting, restart the power supply.

6.2.2 Connection of Limit Input and Near Home Input

For the system which uses the over limit switches and near home switch, connect them to the I/O connector of Servo Amplifier A6N/A5N.

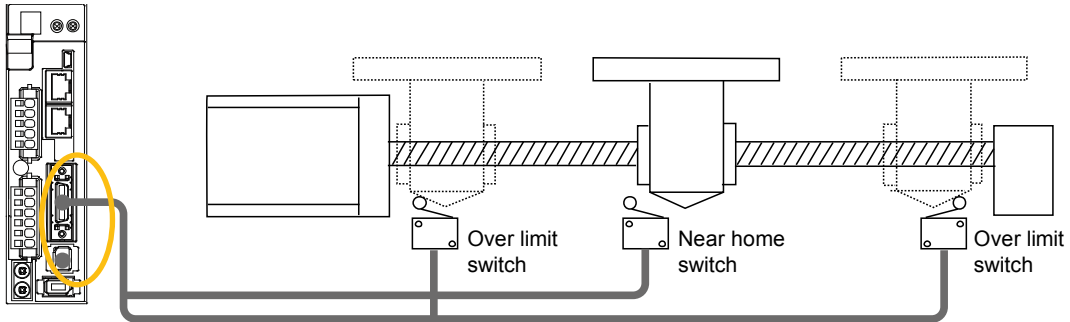

■ I/O connector (X4): Allocation of functions at the factory setting

X4 connector		Function at the factory setting			Application on the FP-XH M8N Control Unit side
Name	Pin no.	Signal name	Code	Logic	
SI1	5	General-purpose monitor input 5	SI-MON5	A contact	
SI2	7	CW over-travel inhibit input	POT	B contact	It is used as limit +.
SI3	8	CCW over-travel inhibit input	NOT	B contact	It is used as limit -.
SI4	9	General-purpose monitor input 1	SI-MON1	A contact	
SI5	10	Near home input	HOME	A contact	It is used as a near home input.
SI6	11	External lutch input 2	EXT2	A contact	
SI7	12	External lutch input 3	EXT3	A contact	
SI8	13	General-purpose monitor input 4	SI-MON4	A contact	

(Note 1): The above table shows the allocation before shipment. It varies according to the setting of PANATERM.



◆ KEY POINTS

- When using the FP-XH M8N Control Unit in combination with the servo amplifier A6N/A5N, the over-travel inhibit inputs (POT, NOT) are used as limit inputs. For using them as limit inputs, it is necessary to set the limit switch to "Valid" in the "Axis parameter setting" menu of Configurator PM7.

6.2.3 Combination of Parameters and Home Return Methods

When using either "DOG method 2" or "Limit method 2" for the home return method, change the parameters on the AMP side to the pattern B described as below. If the operation is executed with the pattern A setting (factory default setting), the latch input allocation error protection (error code 0821H:3-38) will occur.

■ Home return method and AMP parameter setting (A: Available, Blank: Not available)

FP-XH M8N Home return method	Reference home position	A6N/A5N parameters	
		Pattern A	Pattern B
DOG method 1	Home (Z phase)	A	A
DOG method 2	Near home (DOG)		A
DOG method 3	Home (Z phase)	A	A
Limit method 1	Home (Z phase)	A	A
Limit method 2	Limit - (NOT) / Limit + (POT)		A
Z phase method	Home (Z phase)	A	A
Stop-on-contact method 1	Mechanical stop mechanism such as a stopper	A	A
Stop-on-contact method 2	Home (Z phase)	A	A
Data set method	-	A	A

■ Pattern A (Factory default setting)

Parameter no.	X4 connector		Parameter value (HEX)	Pin assign setting		Revised items
	Terminal name	Terminal no.				
Pr 4.00	SI1	5	00323232H	SI-MON5	A contact	
Pr 4.01	SI2	7	00818181H	POT	B contact	A
Pr 4.02	SI3	8	00828282H	NOT	B contact	A
Pr 4.03	SI4	9	002E2E2EH	SI-MON1	A contact	
Pr 4.04	SI5	10	00222222H	HOME	A contact	
Pr 4.05	SI6	11	00212121H	EXT2	A contact	A
Pr 4.06	SI7	12	002B2B2BH	EXT3	A contact	A
Pr 4.07	SI8	13	00313131H	SI-MON4	A contact	

■ Pattern B (After change)

Parameter no.	X4 connector		Parameter value (HEX)	Pin assign setting		Revised items
	Terminal name	Terminal no.				
Pr 4.00	SI1	5	00323232H	SI-MON5	A contact	
Pr 4.01	SI2	7	00000000H	Invalid		A
Pr 4.02	SI3	8	00000000H	Invalid		A
Pr 4.03	SI4	9	002E2E2EH	SI-MON1	A contact	
Pr 4.04	SI5	10	00222222H	HOME	A contact	
Pr 4.05	SI6	11	00010101H	POT	A contact	A
Pr 4.06	SI7	12	00020202H	NOT	A contact	A
Pr 4.07	SI8	13	00313131H	SI-MON4	A contact	

6.2.4 Connection of General-purpose Monitor Input

- When using the FP-XH M8N Control Unit in combination with the servo amplifier A6N/A5N, up to two general-purpose monitor inputs can be used. The general-purpose monitor input is connected to the servo amplifier I/O connector (X4).
- The general-purpose monitor inputs (SI-MON1 and SI-MON2) connected to the servo amplifier can be read in the input area WX125 of the FP-XH M8N Control Unit.
- For using the general-purpose monitor input, it is necessary to allocate the input signal function to them by the parameter of the servo amplifier. By default, the general-purpose monitor input (SI-MON1) is allocated to SI4 (pin no. 9) of the I/O connector. Refer to “p.6-4”.

6.2.5 Connection of RTEX Operation Output

- When using the FP-XH M8N Control Unit in combination with the servo amplifier A6N/A5N, up to two RTEX operation outputs can be used. The RTEX operation output is connected to the servo amplifier I/O connector (X4).
- The RTEX operation outputs (EX-OUT1 and EX-OUT2) connected to the servo amplifier can be controlled in the output area WY125 of the FP-XH M8N Control Unit.
- For controlling the general-purpose output connected to the servo amplifier, it is necessary to allocate the output signal function by the parameter of the servo amplifier. By default, the RTEX operation output 1 (EX-OUT1) is allocated to SO2 (pin no. 25/no.26) of the I/O connector.

■ I/O connector (X4): Allocation of functions at the factory setting

X4 connector		Function at the factory setting	
Name	Pin no.	Signal name	Code
SO1	1	External brake release signal	BRK-OFF
	2		
SO2	25	RTEX operation output 1	EX-OUT1
	26		
SO3	3	Alarm output	ALM
	4		

(Note 1): The above table shows the allocation before shipment. It varies according to the setting of PANATERM.

6.3 Connection of Network

6.3.1 Wiring Method

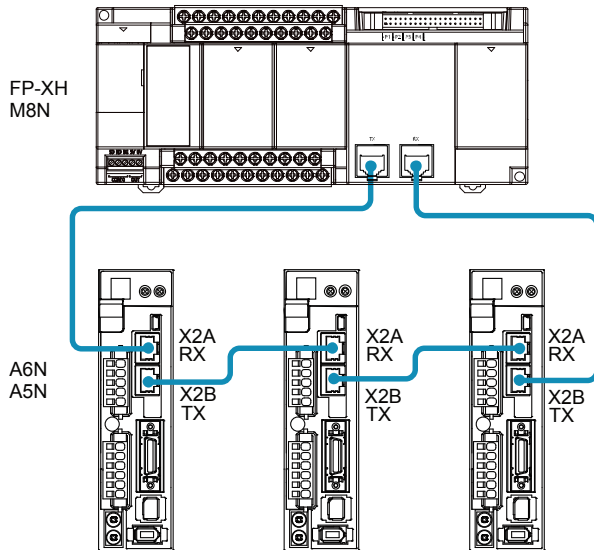

- The cable connected to "TX" of the FP-XH M8N Control Unit is connected to the connector "X2A connector (RX)" of the servo amplifier. Connect X2B (TX) and then X2A (RX) to the amplifier in this order.
- Perform the loop connection so that the cable returns to "RX" of the FP-XH M8N Control Unit from "X2B (TX)" of the terminal AMP.
- The distance between each node should be within 100 m and the total length should be within 200 m.

6.3.2 Precautions on Wiring

- Always use shielded twisted pair (STP) cables that are compatible with category 5e or higher.
- Turn off the power supply of the system before wiring cables.
- To prevent the cable from coming off, securely connect the connector of the cable to the network connector (RJ45 connector) of the unit.
- A hub for Ethernet cannot be used.



◆ REFERENCE

- For the details of the cable specifications and precautions, refer to the document "RTEX Cable" available on the web page.

<https://industrial.panasonic.com/ww/products/motors-compressors/fa-motors/ac-servo-motors>

6.4 Pulse Input Connection

6.4.1 Linear Driver Type

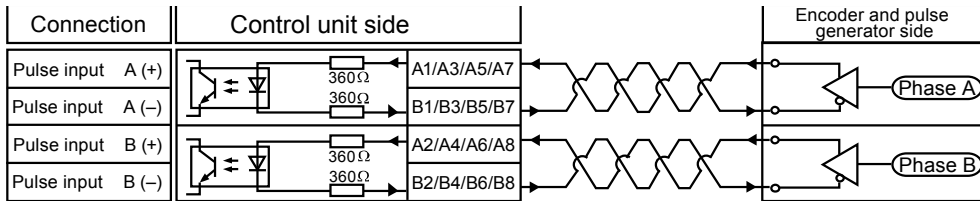

6.4.2 Transistor Open-collector Type

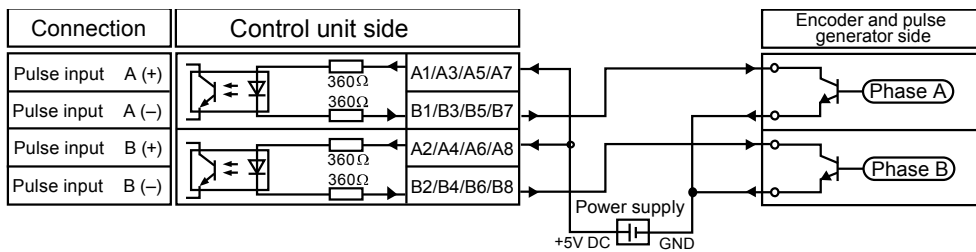

6.4.3 Transistor Resistor Pulling Up Type

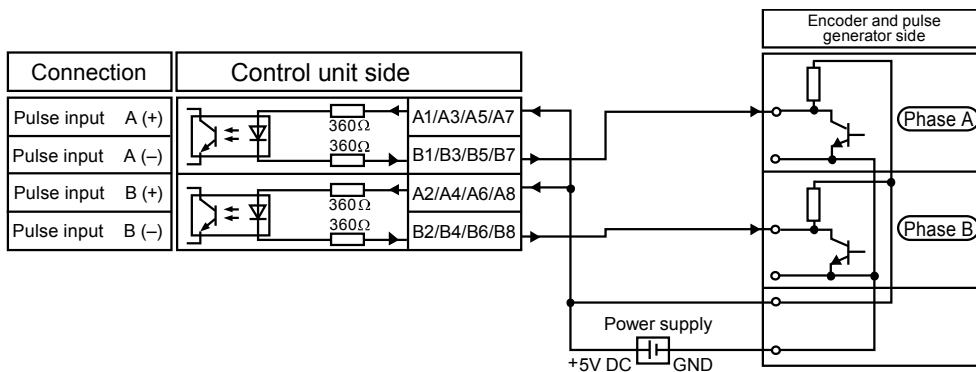



◆ KEY POINTS

- Pulsar input operation and high-speed counter use the same pulse input terminal, so any of the above may be selected.
- It is recommended to connect them with a twisted-pair cable.
- When counting 2-phase input of coder, etc., to avoid wrong counting, please set the pulse input counting frequency multiplication to X4 or X2 via the control codes.

Note: please use pulse input A and pulse input B signals within the following specifications.

■ When pulse input A and pulse input B are used in 2-phase

It is 2-phase input when used as pulsar input.

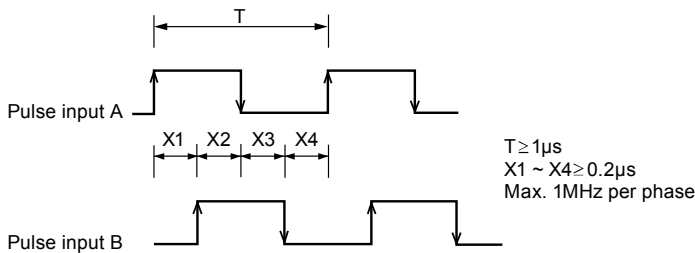

■ When pulse input A and pulse input B are used as direction detection input

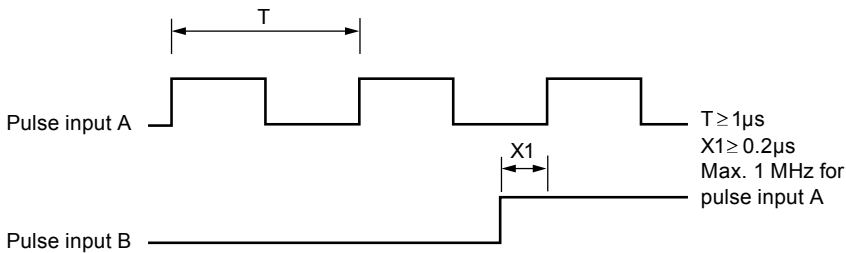

■ When pulse input A and pulse input B are used as individual input

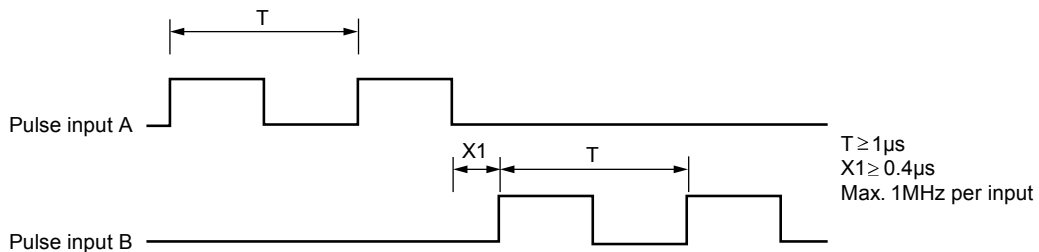

6.4.4 Precautions on Wiring

- It is recommended to use a twisted-pair cable for pulse input connection.
- Please control the following wiring lengths within the range shown in the table.

■ Wiring Length

Input / Output signal	Wiring Length
Pulse input	within 30 m

6.4.5 Specifications of Scattered Cable Connectors

Connectors used for scattered cable connector need not to be peeled off the insulation layer. Connect them with special tools.

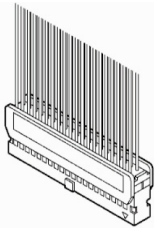

Scattered cable connector (40P)

■ Applicable wires (stranded wire)

Specification	Nominal cross-section area	Insulation layer O.D.	Rated current
AWG#22	0.3 mm ²	φ1.5-φ1.1	3 A
AWG#24	0.2 mm ²		

■ Scattered cable connector (unit accessories)

Manufacturer	Parts composition	Quantity
The company	Enclosures (40P)	1PC / 2 sets
	Half-open enclosures (40P)	2PC2 / 2 sets
	Contact head (AW22, 24) 5-pin	8PC2 / 2 sets

(Note): For separate order, please specify AFP2801 (2 sets).

■ Special tools

Manufacturer	Product no.
The company	AXY52000FP

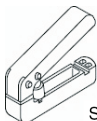

Special tools

6.4.6 Usage of Scattered Cable Connector

The insulation layer can be crimped to save wiring time.

Steps

1. Remove the contact piece from the carrier and crimp it into the tool.

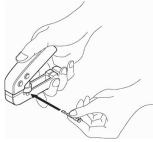

2. Insert the wire with the insulation layer directly into the contact piece, slightly grip the tool for crimping.



3. Insert the wire into the terminal box after the crimping.

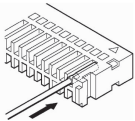

4. Close the cover after insertion of the wire.

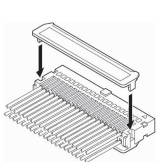

◆ KEY POINTS

- **Contact pull pin can be used for correction in case of wrong wiring. Wrong wiring or wrong crimping of wire can be corrected with the attached contact pull pin.**

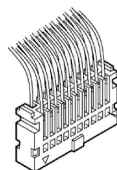
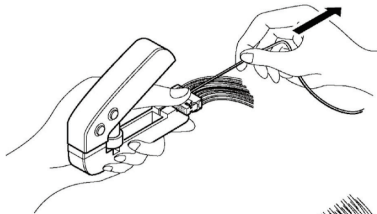

Push the terminal box against the crimping tool to make the pull pin contact with this part.

7

Power On/Off and Check Items

7.1 Before Turning On the Power

System configuration example

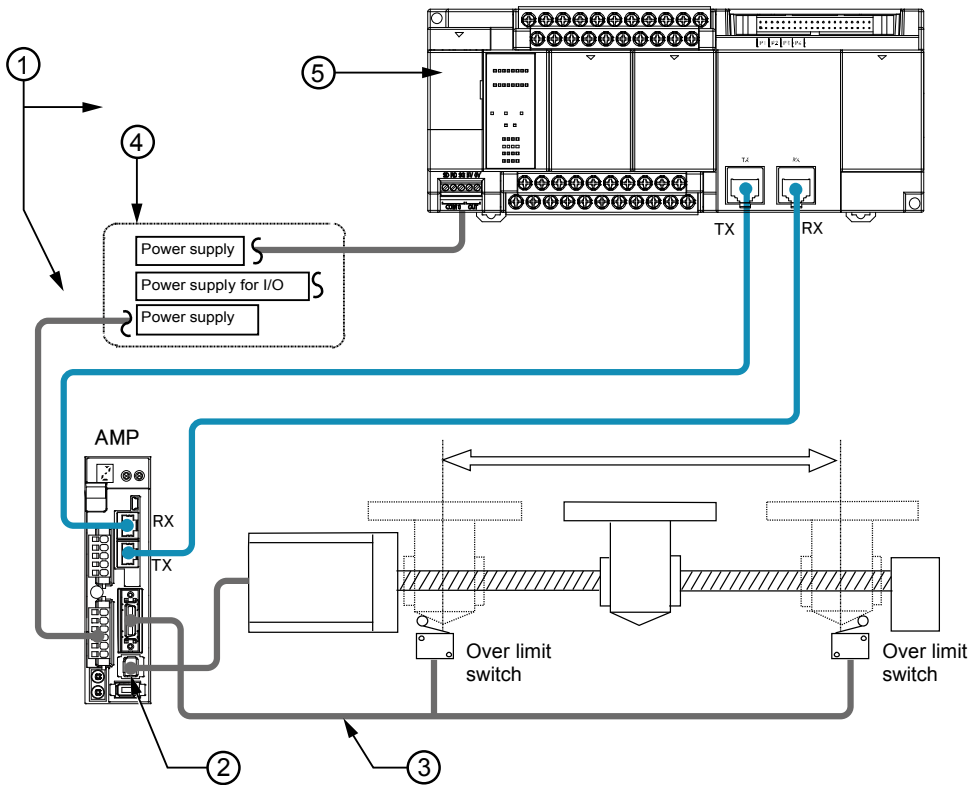

■ Confirmation matters before the power supply is turned on

No.	Item	Confirmation Contents
①	Confirm connection of each device	Check and ensure that each device has been designed and connected.
②	Confirm the servo amplifier	Check the wiring of servo amplifier and parameter settings.
③	Confirm the installation of the safety circuit	Check the connection between the servo amplifier and over limit switches. Check the installation condition of the over limit switches.
④	Confirm the sequence setting of turning on the power supply	Please verify whether the steps for turning on the power supply are set according to the requirements of the "Steps for Turning on the Power Supply".
⑤	Setting of configuration data	Check if the parameters and positioning data are configured in the FP-XH M8N Control Unit as designed.
	Confirmation of mode switch of the control unit.	Set the control unit as PROG. mode. Setting as RUN mode may lead to neglectful actions.
	Confirm user programs	Create programs to turn off the start request of each operation when switching the mode to RUN mode. If they are on, they may activate improperly.

7.2 Procedure for Turning On the Power

7.2.1 Procedure for Turning On the Power

To turn on the power supply of the unit system to be used, consider the performance and status of the external device connected to fully avoid the occurrence of unexpected actions.



◆ PROCEDURE

1. Turn on the power supplies for input and output devices connected to the PLC.
2. Turn on the power supply for the servo amplifier.
3. Turn on the power supply of the PLC.

7.2.2 Procedure for Turning Off the Power



◆ PROCEDURE

1. Check and make sure the rotation of the motor has stopped, and then turn off the power supply for the PLC.
2. Turn off the power supply for the servo amplifier.
3. Turn off the power supply of input and output devices connected to the PLC.

7.3 Check with Power Turned On

7.3.1 Check items after turning power on

On System configuration example

It can be generally divided into four stages for confirmation.

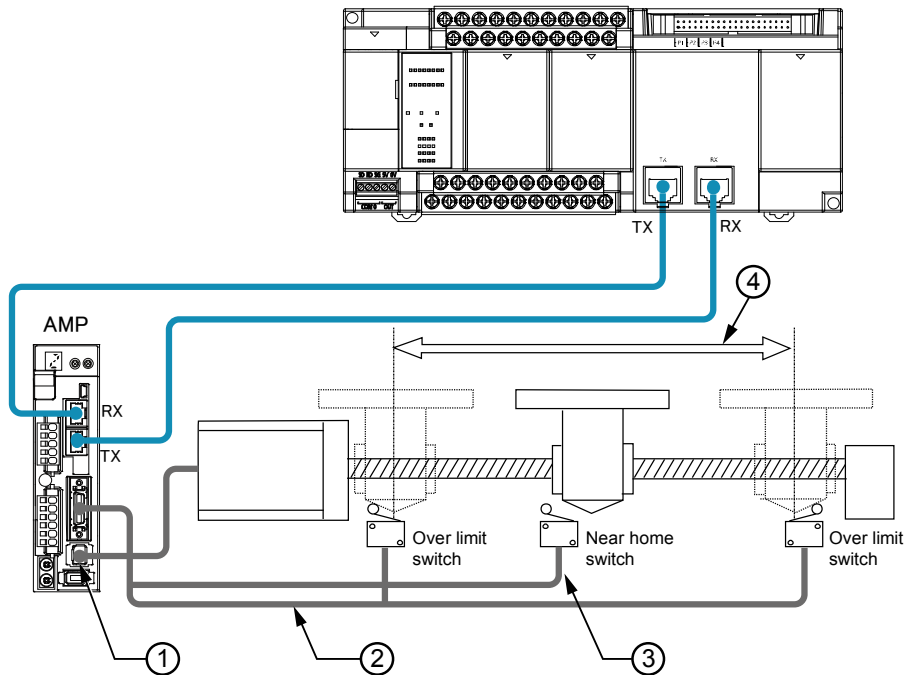

■ Confirmation matters before the power supply is turned on

No.	Item	Confirmation Contents
①	Check the communication state	Check if the communication between FP-XH M8N Control Unit and Servo Amplifier is performed properly.
②	Check the safety circuit based on the PLC unit	Check the connection between the servo amplifier and over limit switches. Check the installation condition of the over limit switches. Check if the over limit switch is loaded as the limit input of FP-XH M8N Control Unit and activated properly by performing JOG operation.
③	Check the near home input	Check the connection between the servo amplifier and near home input. Check the installation condition of the near home input. Check if the near home input is loaded as the near home input of FP-XH M8N Control Unit and activated properly by performing JOG operation or home return operation.
④	Confirm the rotation, movement direction and distance	Confirm the rotation, movement direction and distance through the JOG operation and position control operation.

7.3.2 Checking the network communication state

Step 1

Turn on the powers of the servo amplifier and FP-XH M8N Control Unit in this order.

Step 2

Check if the operation status display LEDs on the FP-XH M8N Control Unit is in the following state.

STATUS: On LINK: On

Points to check

If the STATUS LED is blinking, the network is not established.

If the LINK LED is off, the connection between the "RX" (receiver) and the "TX" of the AMP (sender) is not electrically correct.

7.3.3 Checking the safety circuit based on a unit

Step 1

Check if the input of the over limit switches connected to the servo amplifier is loaded to the unit by operating them forcibly.

Check point

Check if the limit setting is valid, input logic is correct in the parameter setting menu of Configurator PM7.

Step 2

Check if the limit stop is activated at the time of limit input by the tool operation function of Configurator PM7 or performing the JOG operation with a program.

Step 3

Using the JOG operation, check to see if the over limit switch is functioning properly.

■ Limit Input Operation

Conditions	Direction	Limit Status	Operation
When JOG operation is executed	Forward rotation	Limit input (+): ON	Not executable, Error occurs.
		Limit input (-): ON	Executable
	Reverse rotation	Limit input (+): ON	Executable
		Limit input (-): ON	Not executable, Error occurs.
During JOG operation	Forward rotation	Limit input (+): ON	Deceleration stop, Error occurs.
	Reverse rotation	Limit input (-): ON	Deceleration stop, Error occurs.

7.3.4 Checking the operation of near home switch

Step 1

Confirm that it has been normally imported as the input signal on the PLC side for forced operation of the near origin input.

Step 2

Start the home return by the tool operation function of PM7 or inputting the home return program, and check if the operation transits to the deceleration operation by the near home input.

Check point

The logic of near home input depends on the settings of Servo Amplifier and FP-XH M8N Control Unit.

Step 3

Repeat the JOG operation and the home return operation to confirm that the mobile station exactly stop at the origin without offset.

Step 4

If the mobile station doesn't exactly stop at the origin, change the position of the near origin input or reduce the home return speed to make it accurately stop at the origin.

7.3.5 Checking the rotation, movement direction and distance

Step 1

Check whether the rotation and movement direction is correct through the JOG operation or automatic acceleration and deceleration operation.

Check point

The rotation direction depends on the installation of ball screws and the "CW/CCW Direction Setting" of parameters.

Step 2

Perform the JOG operation or position control operation and confirm whether the movement distance is consistent with the design.

Check point

The movement distance depends on the pitch of ball screws, reduction gear ratio and the set movement amount of the position control data.

8

Steps Before Running

8.1 Before Turning on the Power

8.1.1 Check Items

After wiring, check the following items before turning on the power.

■ Check Items

	Item	Description
1	Unit mounting	<ul style="list-style-type: none">● The name of each unit matches the device list as designed.● Mounting screws on the unit are securely tightened. No looseness.
2	Wiring	<ul style="list-style-type: none">● The terminal screws are securely tightened. No looseness.● Wiring and signal names of the terminals are consistent.● Wire specifications fully fit the current size.
3	Cable connection	<ul style="list-style-type: none">● Cables are securely connected.
4	Mode setting	<ul style="list-style-type: none">● The mode toggle switch is set to "PROG." mode.
5	Others	<ul style="list-style-type: none">● Please carefully confirm the possibility of accidents.

8.1.2 Steps Before Running

For configuration after wiring, the steps before running are as follows.

1. Power ON

- (1) Before turning on the power, please check "7 Power On/Off and" and "8.1.1 Check Items".
- (2) After switching on the power of the control unit, please confirm that the control unit's PROG. LED (green) is lit.



2. Create the program

- (1) Use the tool software to create a program.
- (2) Use the "Totally Check Project" of the tool software to check for syntax errors.



3. Confirm the output wiring

Use the mandatory input / output function etc. to check the output wiring.



4. Confirm the input wiring

Check the input wiring through the input display LED or the monitoring function of the tool software.



5. Test run

- (1) Set the mode toggle switch to "RUN" mode, confirm that the "RUN" LED is lit.
- (2) Confirm the serial actions.



6. Commissioning

- (1) When there is an abnormal action, use the monitoring function of the tool software to confirm the program's abnormality.
- (2) Modify the program.



7. Save the program

Save the program created.

8.2 Offline Editing of the Program

8.2.1 Program Elements

Create the following items as program data according to the following steps.

■ Program composition

Type	Description
Program	Any program
Comments	Maximum 1MB I/O comments, description, comments between the lines
System register	Set the allocation for hold area using the operation memory, the operation mode during an abnormality, communications, high-speed counter when using pulse output function.
Position control parameter Position control data table data	Set via the Configurator PM7. Save the position control parameters and position control data table information to be set as partial program files. You can export or import it via the Configurator PM7, and save only the position control related data as other file.

8.2.2 Settings of the System Register

Follow these steps to set the system register. Explain it as below assuming that the FPWIN GR7 has been started.



◆ PROCEDURE

1. In the menu bar, select "Option"→"System Register Setting".

The "PLC Configuration" dialog box is displayed.

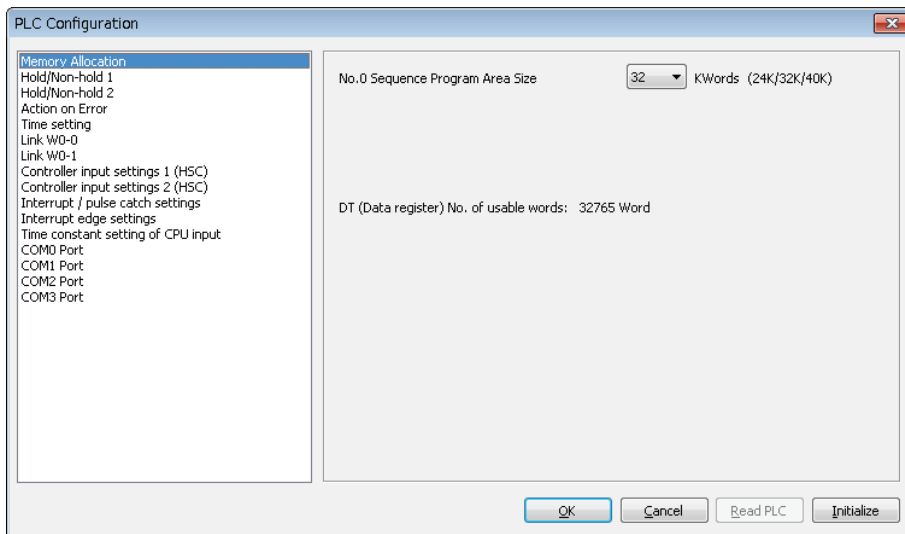

2. **Select any item to set.**
3. **Click the [OK] button.**

The contents have been set are saved as part of the program.

■ Type of system registers

Type	Description
Memory allocation	Set when changing program capacity.
Hold / non-hold	Set when changing hold area of internal relays, data registers and other operation memories. To ensure these settings are effect, you must install the memory backup battery (sold separately).
Action on error	Select the operating mode used when an operation error occurs. In addition, the abnormality warning function shall be set as active when installing memory backup battery.
Time setting	Set the timeout time when using the communication function and the time for constant scanning.
Link W0 setting	Allocate the station number and the link area when using the inter-PLC link function.
Controller input setting (HSC)	Allocate the input and output signal and channel when using HSC (High Speed Counter).
Interruption / pulse catch setting	Specify the inputs allocated when using interrupt input or pulse catch input. When the input is interrupted, an effective pulse edge can be selected.
Interrupt edge setting	
Time constant setting of CPU input	Assign a input for time constant filter when the input is set as active.
COM port setting	Set the station number and communication speed, transmission format and other communication parameters via the COM port when using the communication function.



◆ KEY POINTS

- **Set the system register when using functions and changing the hold area from default state. There is no need to set when the appropriate function is not in use.**

8.2.3 Setting of Position Control Parameters

Position control parameters are set via the Configurator PM7. Start the Configurator PM7 from the "Options" menu of FPWIN GR7.



◆ REFERENCE

- **For setting of position control parameters, please refer to "Chapter 9 Setting of Position Control Parameters".**
- **For details on the system register, refer to "26.5 Table of System Registers".**

8.3 Program Download and Run

8.3.1 Before Turning on the Power

Before turning on the power, verify the mode toggle switch of the control unit. According to the different states when the power is on, the behavior will change as following.

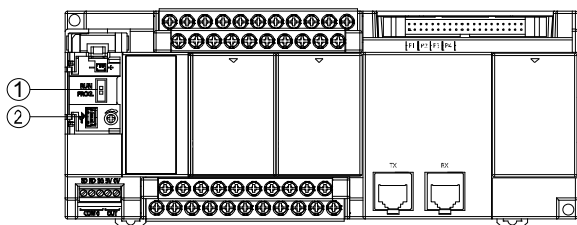

①	Mode toggle switch	②	USB port
---	--------------------	---	----------

■ Difference between mode behaviors

Type	Description
When the power is turned on in PROG. mode	<ul style="list-style-type: none"> ● When the power is turned on, show as the state of data saved in the control unit and computer (program, comments, system register data, data register). ● Through the operation of the tool software, it can change to status: computer → download to the control unit, or control unit → upload to your computer. ● If the program and other required data are not written in the control unit, turn on the power via PROG. mode.
When the power is turned on in the RUN mode	<ul style="list-style-type: none"> ● When the power is turned on, transmit the datum saved in the control unit's internal memory (F-ROM) to the control unit memory, then start running. ● When the program and other required data have been saved, turn on the power via RUN mode when running.

■ Mode switch based on the tool software

- If it is online after the power is on, the operation mode can be switched by the tool software. However, when the power is turned on again after the power is turned off, run in the the mode selected by the mode toggle switch.

■ Connection of the computer and control unit

- The USB port of the control unit is connected to the computer. Use USB 2.0 cable (A: mini B) when connecting

8.3.2 Program Downloading and Mode Switching

- Programs created by the tool software can be downloaded to the control unit.
- The downloaded program are saved to the program memory (F-ROM). It can be saved even in case of power outage.

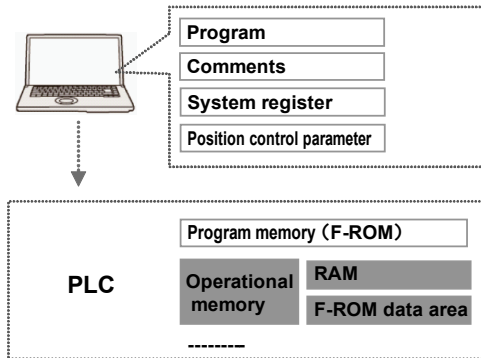

■ Download steps

Use the following steps to download the program data. Explain it as below assuming that the FPWIN GR7 has been started.



◆ PROCEDURE

1. Select "Online" → "Switch to Online Mode" from the menu bar.
2. Select "Online" → "Download to PLC" (Entire Project) from the menu bar.

The confirmation dialog box is displayed.

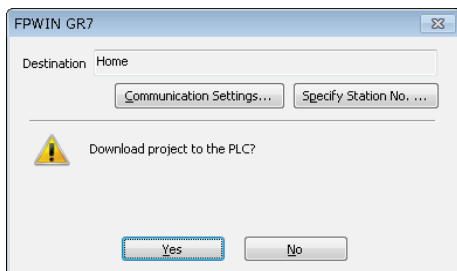

4. Click the [Yes] button.

Perform the download. In addition, the information dialog box for confirming whether to switch the mode displays.

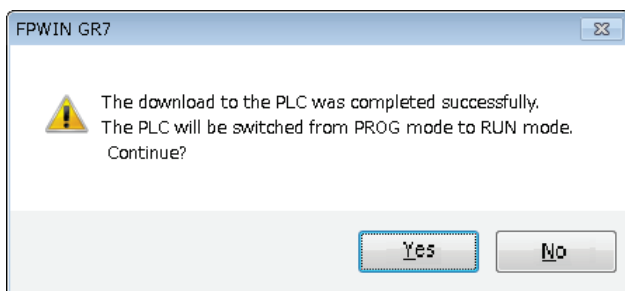

5. Click [Yes] or [No] button.

Click "Yes" to switch to RUN mode. Click "No" to switch to monitoring mode.



◆ KEY POINTS

- When you switch to RUN mode, switch it after confirming that there will be no danger even the PLC is in motion.
- When you switch to RUN mode, the ERR LED lights up after an error occurs, and then return to PROG. mode. Please refer to "20.2 What to Do if an Error Occurs".

■ When "MEWNET device open circuit error" appears

Follow these steps to clear the error status.

**◆ PROCEDURE**

1. **Verify that the power of the control unit is switched on.**
2. **Verify that the computer and the control unit are connected via a USB cable.**
3. **Select "Online" → "Communication Settings" from the menu bar.**

The "Communication Settings" dialog is displayed.

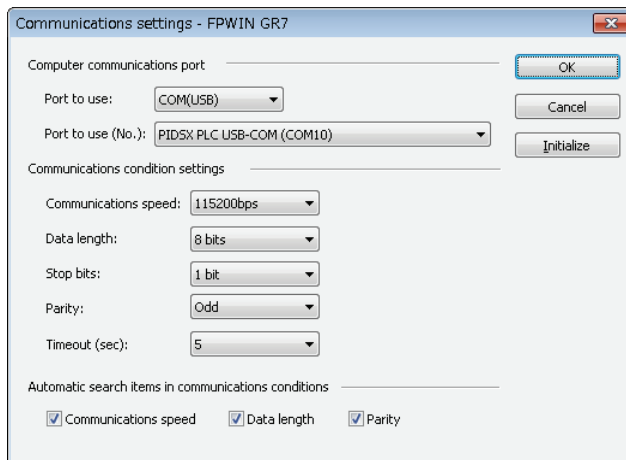

4. **Confirm the port number and click [OK] button.**

Make sure the computer and the control unit can communicate.



◆ **KEY POINTS**

- **Port No. can be confirmed through the computer's device manager.**

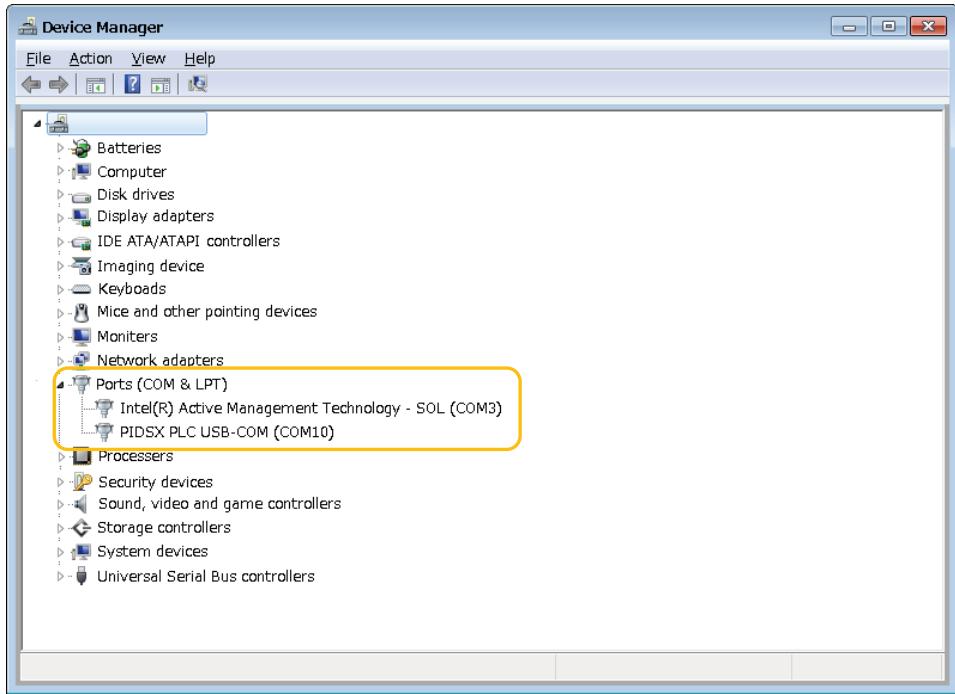

8.3.3 Overall Program Check

- Use the Overall Check Function of the tool software to check for syntax errors.
- You can check for dual use of the coil and match instruction (MC and MCE, JP and LBL, SUB and RET, etc.) defects.



◆ PROCEDURE

1. Select "Online" → "Switch to Online Mode" from the menu bar.
2. Select "Debug" → "Totally Check Project" from the menu bar.

The Totally Check Project dialog box is displayed.

3. Click the [Execute] button.

The check result is displayed. When there is an error, click the "Jump" button to jump to the appropriate location.

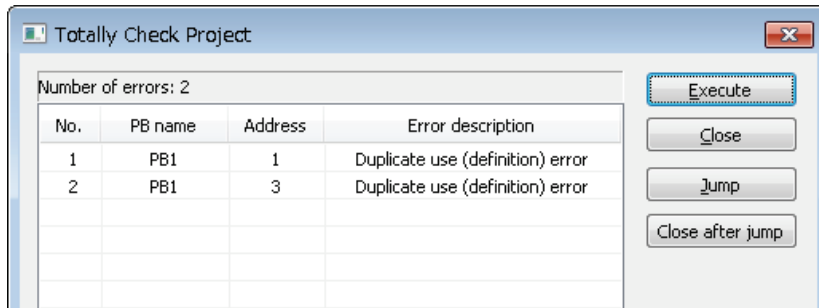

8.3.4 Program Verify

To confirm that the program being edited on the computer is the same as that on the control unit, check it when necessary. Explain it as below assuming that the FPWIN GR7 has been started.



◆ PROCEDURE

1. Select "Online" → "Switch to Online Mode" from the menu bar.
2. Select "Debug" → "Verify Project" from the menu bar.

The Verify Project dialog box is displayed.

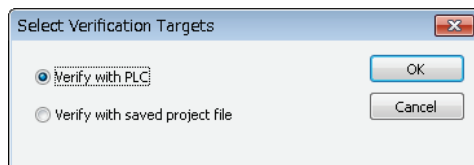

3. Select the object to be checked and click the [OK] button.

The "Select Item to Check" dialog box is displayed.

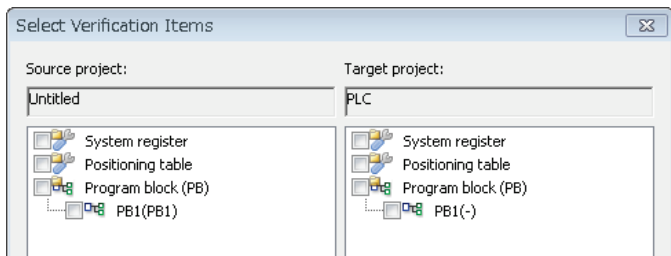

4. Select the item and click the [Execute] Button.

The check result is displayed. Inconsistent items will be shown in peach. Then double-click this item to show details.

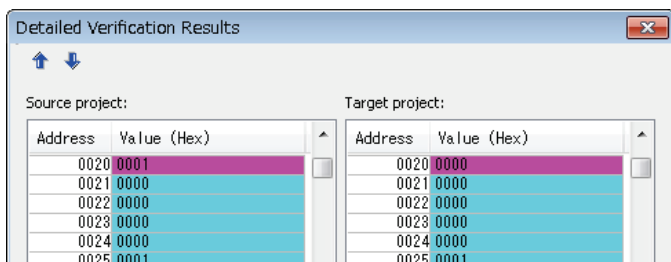
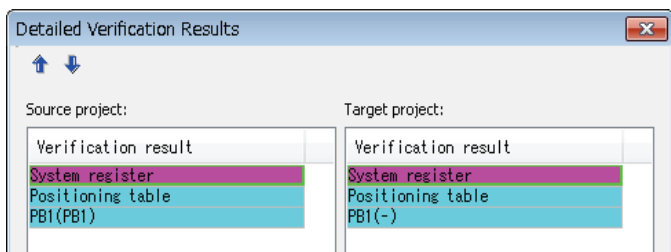

■ Check result

Check contents	Example in case of inconsistency
System register	Shows inconsistent error when the Settings of the system register are not consistent.
Position control data table	Shown as inconsistent error when the position control parameters and position control data table are different.
PB1	Displays inconsistent program block numbers.



◆ KEY POINTS

- When switching from offline to online, if the program and system register are inconsistent, the message box showing the content is displayed.

8.4 Online Editing

8.4.1 Online Editing Summary

In the FP-XH M8N control unit, even if the computer and the PLC are connected online, it can also be edited using the following conditions.

■ Online Editing

Type	Mode		Emphasis
	PROG	RUN	
Program	A	A	<ul style="list-style-type: none"> For pixel input mode, up to 512 steps can be rewritten. To ensure the compatibility of the program, rewriting in RUN mode is conditional. You can download the program and all comments even in RUN mode.
Comments	A	A	<ul style="list-style-type: none"> You can modify the program and comments even in RUN mode.
System register	A	N/A	<ul style="list-style-type: none"> Rewriting is only possible in PROG. mode. To rewrite in RUN mode, it will show a confirmation message box to switch to PROG. mode.
Position control data	A	N/A	<ul style="list-style-type: none"> Rewriting is only possible in PROG. mode. To rewrite in RUN mode, it will show a confirmation message box to switch to PROG. mode.

(Note 1): In case of online editing, although the entered comments show, you can not save them to the memory of the control unit.

8.4.2 Online Editing of the Program



WARNING

When changing the program during operation, make sure it is safe before changing.

■ Online Editing of the Program

You can execute online editing of the program in PROG. mode or RUN mode.



◆ REFERENCE

- For details and restrictions on rewriting during RUN, refer to FP-X User's Manual (No.ARCT1F409E).

■ Block rewrite steps

You can change the program in PROG. mode or RUN mode. The following is a description of the contents being edited online by FPCWIN GR7.



◆ PROCEDURE

1. **After changing any program, press <Ctrl> button + <F1> button to perform PB conversion.**

The confirmation dialog box is displayed.

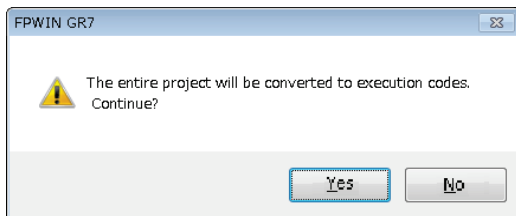

2. **Click the [Yes] button.**

The confirmation dialog box for comment change is displayed.

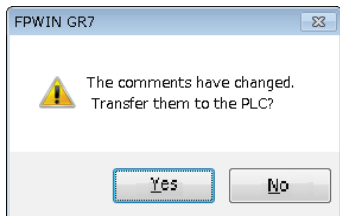

3. **Click the [Yes] button.**

At the end of the normal conversion, the information is displayed in the status bar.



◆ KEY POINTS

- **The line comment is connected with the Boolean address of the program and managed within the PLC. When changing the program online, download the program to match the position of the line comment.**

8.4.3 Online Editing of the System Register

Changing the system register is only possible in PROG. mode. The following is a description of the contents being edited online by FPCWIN GR7.



◆ PROCEDURE

1. In the menu bar, select "Option"→"System Register Settings".

The "PLC Configuration" dialog box is displayed.

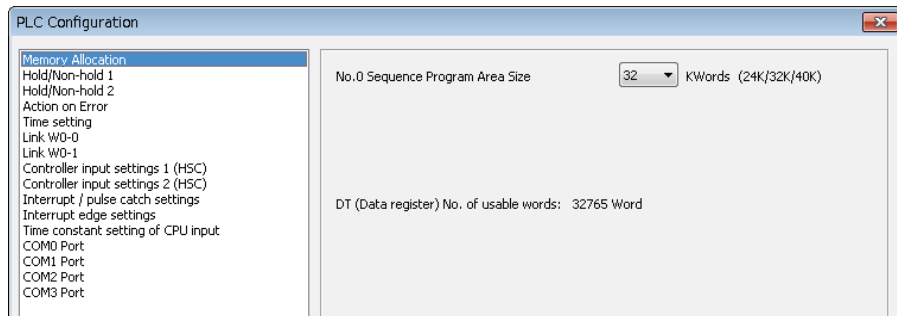

2. Change any system register and click [OK] button.

The confirmation dialog box is displayed.

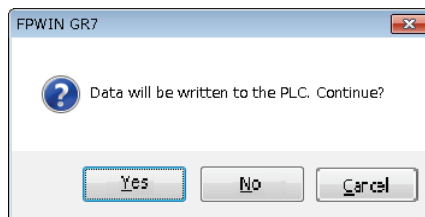

3. Click the [Yes] button.

The information indicating system register writing is completed shows in the PLC.



◆ KEY POINTS

- Please change the system register No.0 in PROG. mode.

8.5 Program block

8.5.1 Program block summary

In FPWIN GR7, programs can be divided into several program blocks (PB) for edition.

■ Restrictions for program blocks (FP-XH)

Item	Description
Max. number of PBs	up to 256
Program step number of each PB	No limit

■ Execution sequence of PBs

- The PBs are executed as a program after being combined.
- Please describe only 1 ED instruction at the end of the main program. Programs before the ED instruction will be executed circularly.
- Please set the secondary programs (interruption programs, subprograms) after the ED instruction. "Match not established error" and "instruction position error" will be displayed in case of incorrect sequence.

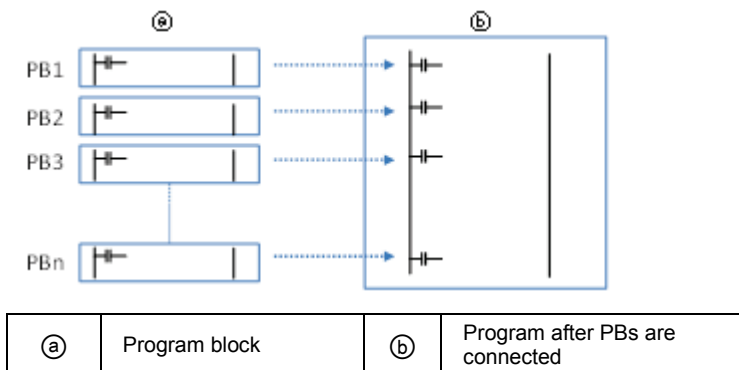

8.5.2 Change Sequence of PBs

The execution sequence of PBs can be altered freely after compiling the PBs. Explain it as below assuming that the 3 PBs has been compiled.



◆ PROCEDURE

1. Double-click "Change execution order" from the project tree.

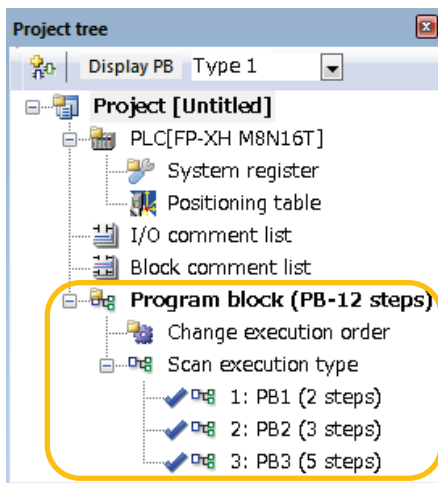

The "Change PB Execution Order" dialog box is displayed.

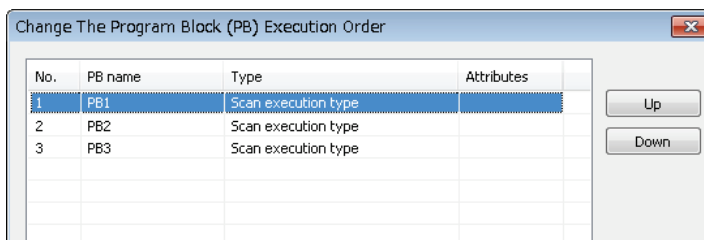

2. Select the PB for which the execution sequence is to be changed, click the [Up] or [Down] button.
3. Click the [Yes] button.

The name of the PB is displayed on the project tree according to the changed execution.

9

Setting of Position Control Parameters

9.1 Axis Allocation for Use

9.1.1 Settings in Configurator PM7

Assign all channels to be used and their usage via the FPWIN GR7. The following steps are performed with the Configurator PM7 that has been started as a premise.



◆ PROCEDURE

1. Select "Options"→"Positioning Table Settings" from the menu bar. Or double-click the "Positioning table" from the project tree.

The "Configurator PM7" configuration menu is started.

Table number	Operation pattern	Control method	X axis (1) mo...	Acceleratio...	Acceleration ...	Deceleration ...	Target s...	Dwell time (ms)	Au ^
1	E: End point	I: Increment	0	L: Linear	100	100	1000	0	
2	E: End point	I: Increment	0	L: Linear	100	100	1000	0	
3	E: End point	I: Increment	0	L: Linear	100	100	1000	0	
4	E: End point	I: Increment	0	L: Linear	100	100	1000	0	

2. Select "Axis Settings"→"Change Axis" from the menu bar.

The dialog box of for setting of the axis to be used appears.

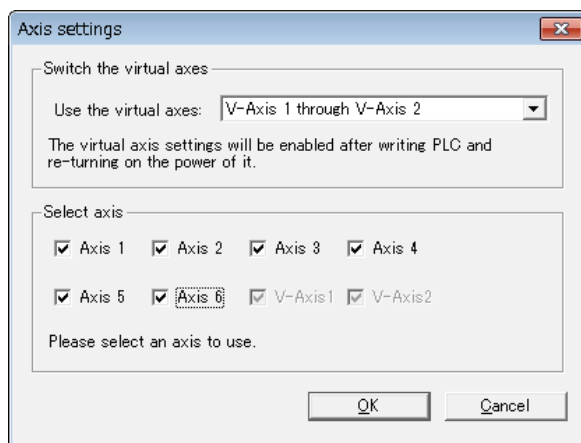

3. When using the virtual axes for the synchronous control, select from the drop-down list.

When selecting V-Axis 1, "Axis 8" changes to "V-Axis 1". When selecting V-Axis 1 through V-Axis 2, "Axis 7" changes to "V-Axis 1", and "Axis 8" changes to "V-Axis 2".

4. Select the axis to be used and click [OK].

The dialog box for setting interpolation operation group appears.

5. For performing the interpolation control, drag the icon of each axis to be allocated for interpolation to the interpolation group field.

The figure below shows the cases when axis 1 and axis 2 are assigned to the interpolation operation group.

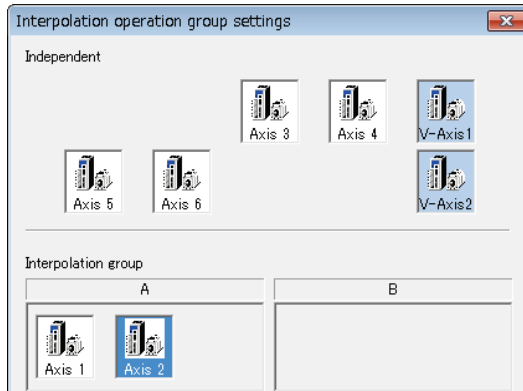

6. Click the [OK] button.

The confirmation message is displayed.

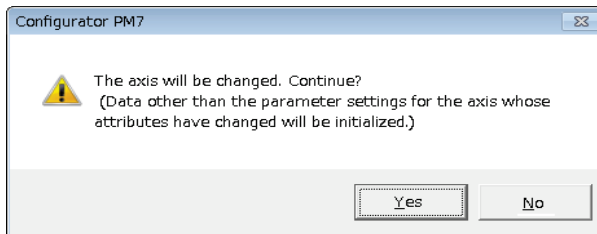

7. Confirm the change and click [Yes].

Create the data table tab respectively according to the set group.

19	E: End point	I: Incr...	0	L: Linear	100	100	1000
20	E: End point	I: Incr...	0	L: Linear	100	100	1000

Virtual 1Axis Virtual 2Axis [A] 1,2Axis 3Axis 4Axis 5Axis 6Axis



◆ KEY POINTS

- After setting the interpolation group, settings for the movements of the X-axis, Y-axis or Z-axis and the interpolation operations will be added to the data table and displayed on the tab as group [A] and [B].
- Virtual axes and slave axes under synchronized control cannot be set to the interpolation operation groups.
The master axis of the synchronous control can be set as the interpolation group.
- When changing the setting of "use of virtual axes", restart the power supply after writing to the PLC. The set information will be reflected.
- Press × to close during the edition to cancel and exit.

9.2 Parameter settings

9.2.1 Parameter Settings in Configurator PM7

The parameters common to various controls such as command unit, origin input, logic of limit input and stop time, and the parameters relating to home return and JOG operation are assigned by Configurator PM7. The following steps are performed with the Configurator PM7 that has been started as a premise.



◆ PROCEDURE

1. Select "Axis Settings"→"Parameter Settings" from the menu bar.

The dialog box of "Parameter Settings" appears.

	V-Axis1	V-Axis2	Axis 1 [A]	Axis 2 [A]
Unit setting	Ppulse	Ppulse	Ppulse	Ppulse
Number of pulses per revolution	1	1	1	1
Movement per revolution	1	1	1	1
Clockwise/counterclockwise direction setting	-----	-----	0: Clockwise positive	0: Clockwise positive
Limit switch	-----	-----	N: Disabled	N: Disabled
Limit switch connection	-----	-----	S: Standard	S: Standard
Software limit (Positioning control)	N: Disabled	N: Disabled	N: Disabled	N: Disabled
Software limit (Home return)	N: Disabled	N: Disabled	N: Disabled	N: Disabled
Software limit (JOG operation)	N: Disabled	N: Disabled	N: Disabled	N: Disabled
Software limit upper limit value	1073741823	1073741823	1073741823	1073741823

2. Set the necessary parameters according to the purpose and press [OK].

After displaying the message "Updating data display", the screen returns to the base screen of Configurator PM7.

3. Select "File"→"Apply Settings" from the menu bar.

The parameters set in Configurator PM7 are applied as the project data being edited.



◆ KEY POINTS

- Closing the window with the X mark during editing the "Parameter settings" dialog cancels and stops the operation.
- To save parameters as a file, select "File" > "Save Setting".

9.2.2 Parameter setting items

Parameter Name	Description	Related Page	
Unit setting	Specify the unit of each axis. Select from the following items. P:pulse, M:um [Min 0.1], M:um [Min 1], I:inch [Min 0.00001], I:inch [Min 0.0001], D:degree [Min 0.1], D:degree [Min 1]	7.3 Check with Power Turned On	
Number of pulses per revolution	Pulses per rotation of the motor (Default: 1) pulse		
Movement per revolution	Movement per rotation of the motor (note 1)		
Pulse output rotation direction	CW+ : set to CW in the + direction of elapsed value CCW+ : set to CCW in the + direction of elapsed value		
Limit switch	Set whether to enable or disable the limit switch. Select from the following items. A: Enabled, N: Disabled		
Limit switch connection	Set the connections of the + direction limit switch and - direction limit switch. Select from the following items. S: Standard, R: Reverse connection		
Software limit (Positioning control)	Set whether to enable or disable the software limit in positioning control. Select from the following items. A: Enabled, N: Disabled	17.2 Software Limit	
Software limit (Home return)			
Software limit (JOG operation)			
Software limit upper limit value			When starting the data in which the current position exceeds this value in operation, an error occurs. For performing infinite rotation, set the both software limits to 0. Setting range: -2,147,482,624-2,147,482,624
Software limit upper limit value			
Auxiliary output mode	Set the timing when auxiliary output contact turns ON and the output timing of auxiliary output code. In With mode, auxiliary output is reflected in operation. In Delay mode, auxiliary output is reflected when the table moves by the amount of the delay ratio (%) to the total movement amount. Select from the following items. N: Not use, W: With mode, D: Delay mode	17.3 Auxiliary Output	
Auxiliary output on time (ms)	Set the time period that auxiliary output contact is ON. Setting range: 0-255 (Default: 10) ms		
Auxiliary output delay ratio (%)	Set the delay ratio (ratio of current movement amount to the total movement amount) for using Delay mode. Auxiliary output is reflected when the movement amount passes over the delay ratio after starting positioning operation. Setting range: 0-100 (Default: 0) %		
Completion width (pulse)	Specify the width of the completion of command operation. Setting range: 0-2,147,482,624 (Default: 10) pulse	17.11 Operation Done Signal	

(Note 1): Only set when units are set to μm , inch or degree. .



◆ KEY POINTS

- In the control unit, as the direction of movement, the direction for increase of elapsed value is set to CW, and the direction for decrease of elapsed value is set to CCW. Therefore, limit input is limit + in the CW direction and limit – in the CCW direction.

Setting of Position Control Parameters

Parameter Name	Description	Related Page
Monitor error - Torque judgment	This is the setting to announce errors or warnings by setting judgement values for the torque command values of motors controlled by AMP of each axis. Select from the following items. N: Disabled, E: Enabled (Error), W: Enabled (Warning)	17.10 Monitor Error (Torque / Actual Speed Judgement)
Monitor error - Torque judgment value (%)	This judgement value is not set in AMP, and used only for monitoring monitor values. Setting range: 0.0-500.0 (Default: 500) %	
Monitor error - Judge the actual speed	This is the setting to announce errors or warnings by setting judgement values for the actual speed of motors controlled by AMP of each axis. Select from the following items. N: Disabled, E: Enabled (Error), W: Enabled (Warning)	
Monitor error - Acutal speed judgemnet value (rpm)	This judgement value is not set in AMP, and used only for monitoring monitor values. Setting range: 0-5000 (Default: 5000) rpm	
Home return - Return setting code	Set the pattern of home return. Select from the following items. 0: DOG method 1 (based on front-end + Z phase), 1: DOG method 2 (based on front-end), 2: DOG method 3 (based on back-end + Z phase), 3: Limit method 1 (limit signal + Z phase), 4: Limit method 2 (limit signal), 5: Z-phase method 1, 7: Stop-on-contact 2 (stop-on-contact + Z phase), 8: Data set method	14.1 Type of Home Return
Home return - Stop-on-contact torque value (%)	Set the torque value for using the stop-on-contact method for home return. It is regarded as a criterion for judging the home return once the torque value of the AMP exceeded this set value by the stop-on-contact. Setting range: 0-5000 (Default: 100) %	
Home return - Stop-on-contact judgment time (ms)	Set the judgement time for using the stop-on-contact method for home return. The position when this set time elapses after the AMP torque value exceeds the stop-on-contact torque is regarded as a decision criterion for the home return by the stop-on-contact method. Setting range: 0-10000 (Default: 100) ms	
Home return - Return direction	Set the operation direction of home return. The limit (-) direction means the decreasing direction of elapsed values. The limit (+) direction means the increasing direction of elapsed values. Select from the following items. 0: Limit (-) direction, 1: Limit (+) direction	
Home return - Return acceleration time (ms)	Set the acceleration time or return time when performing the home return. At the beginning of the home return, accelerates for the specified acceleration time, decelerates for the specified deceleration time after the proximity input and changes to the creep speed. Setting range: 0-10000 (Default: 100) ms	
Home return - Return deceleration time (ms)		
Home return - Return target speed	Set the target speed when performing the home return. When there is no proximity input after starting the home return, accelerates to the target speed. Setting range: 1-2,147,482,624	
Home return - Return creep speed	Set the speed to search the home position after the proximity input. Setting range: 1-2,147,482,624	
Home return - Home coordinates	The coordinate specified for the coordinate origin is registered as the origin after the completion of the home return. Setting range: -2,147,482,624-2,147,482,624 (Default: 0)	

Parameter Name	Description	Related Page
JOG operation - Acceleration/deceleration method	Set the acceleration/deceleration method when performing the JOG operation. Select from the following items. 0: Linear acceleration/deceleration, 1: S-shaped acceleration/deceleration	13.1 Setting and Operation of JOG Operation
JOG operation - JOG acceleration time (ms)	Set the acceleration time or deceleration time when performing the JOG operation. At the beginning of the JOG operation, accelerates for the specified acceleration time, decelerates for specified deceleration time when the starting contact (I/O) of the JOG operation turns off, and stops. Setting range: 0-10000 (Default: 100) ms	
JOG operation - JOG deceleration time (ms)		
JOG operation - JOG target speed	Set the target speed for performing the JOG operation. After starting the JOG operation, accelerates to the target speed by a specified acceleration operation while the starting contact (I/O) of the JOG operation is on. After reaching the target speed, the operation is performed at the target speed. Setting range: 1-2,147,482,624	
Emergency stop deceleration time (ms)	When the emergency stop is requested by I/O, the deceleration operation is complete in this deceleration time. Setting range: 0-10000 (Default: 100) ms	16.1 Types and Settings of Stop Function
Limit stop deceleration time (ms)	The deceleration operation is complete in this deceleration time at the time of limit input. Setting range: 0-10000 (Default: 100) ms	
Error stop deceleration time (ms)	When an error occurs, the deceleration operation is complete in this deceleration time. Setting range: 0-10000 (Default: 100) ms	
J point - Operation setting code	Set the acceleration/deceleration method when performing the J point control. Select from the following items. 0: Linear acceleration/deceleration, 1: S-shaped acceleration/deceleration	11.1.5 Setting and Operation of J-point Control
J-point - Acceleration time (ms)	Set the acceleration time when performing the J point control. Setting range: 0-10000 (Default: 100) ms	
J-point - Deceleration time (ms)		
J-point - Target speed	Set the target speed when performing the J point control. After starting the J point control, it reaches the target speed in the acceleration time. Setting range: 1-2,147,482,624 (Default: 1000)	
Pulsar operation setting code	Select from the channels whose pulse input application is set to "Pulsar". Select from the following items. 0: Pulsar input CH1, 1: Pulsar input CH2, 2: Pulsar input CH3, 3: Pulsar input CH4	15.2 Setting and Operation of Pulsar
Pulsar input method	Set the pulsar input method. Select from the following items. 0: Standard operation, 1: Speed restriction (pulse hold), 2: Speed restriction (time hold)	
Pulsar operation ratio numerator	Set the pulsar operation ratio numerator by multiplying the input pulse train from the pulsar by (the pulsar operation ratio numerator) / (the pulsar operation ratio denominator) to obtain the number of AMP movement pulses. Setting range: 1-32767 (Default: 1)	
Pulsar operation ratio denominator		
Pulsar operation maximum speed	Set the pulsar operation maximum speed. Setting range: 0-2,147,482,624 (Default: 0)	

9.3 Synchronous Parameter / Cam Pattern Settings

9.3.1 Synchronization parameter settings

Parameters required for synchronous control are set via the Configurator PM7. The following steps are performed with the Configurator PM7 that has been started as a premise.



◆ PROCEDURE

1. Select "Axis Setting"→"Synchronization Parameter Setting" from the menu bar.

The dialog box of "Synchronization Parameter Settings" appears.

	Axis 1 [A]	Axis 2 [A]	Axis 3	Axis 4
Select synchronous master axis	No synchronous master	No synchronous master	No synchronous master	No synchronous master
Deceleration stop method	Linear deceleration	Linear deceleration	Linear deceleration	Linear deceleration
Deceleration stop time	100	100	100	100
Electronic gear operation settings	Not use	Not use	Not use	Not use
Gear ratio numerator	1	1	1	1
Gear ratio denominator	1	1	1	1
Gear ratio change time	1	1	1	1
Clutch operation settings	Not use	Not use	Not use	Not use
Clutch on trigger type	I/O clutch on request	I/O clutch on request	I/O clutch on request	I/O clutch on request
Edge selection	Level	Level	Level	Level
Method	Direct	Direct	Direct	Direct
Slip method	Specify slip time	Specify slip time	Specify slip time	Specify slip time
Slip time	1	1	1	1
Slip curve selection	Linear	Linear	Linear	Linear
Clutch off trigger type	I/O clutch off request	I/O clutch off request	I/O clutch off request	I/O clutch off request
Edge selection	Disable	Disable	Disable	Disable
Phase ratio	0	0	0	0

Select the axis and master axis to synchronize.
Please select from the following.
No synchronous master, Axis 1, Axis 2, Axis 3, Axis 4, Axis 5, Axis 6, Axis 7, Axis 8, Virtual Axis 1, Virtual Axis 2, Pulse input CH1, Pulse input CH2, Pulse input CH3, Pul

OK Cancel Copy axis Initialize Help

2. Set the necessary parameters according to the purpose and press [OK].
3. Select "File" > "Apply Setting" from the menu bar.

The parameters set in Configurator PM7 are applied as the project data being edited.



◆ KEY POINTS

- In the case of synchronous control, basic parameters related to I/O operate according to "9.2 Parameter settings".
- Closing the window with the X mark during editing the "Synchronous parameter settings" dialog cancels and stops the operation.
- To save parameters as a file, select "File" > "Save Setting".

9.3.2 Cam Pattern Settings

Use the Configurator PM7 to allocate the electronic cam setting. The following steps are performed with the Configurator PM7 that has been started as a premise.



◆ PROCEDURE

1. Select "Axis Setting" → "Cam pattern Setting" from the menu bar.

The dialog box for cam pattern settings appears.

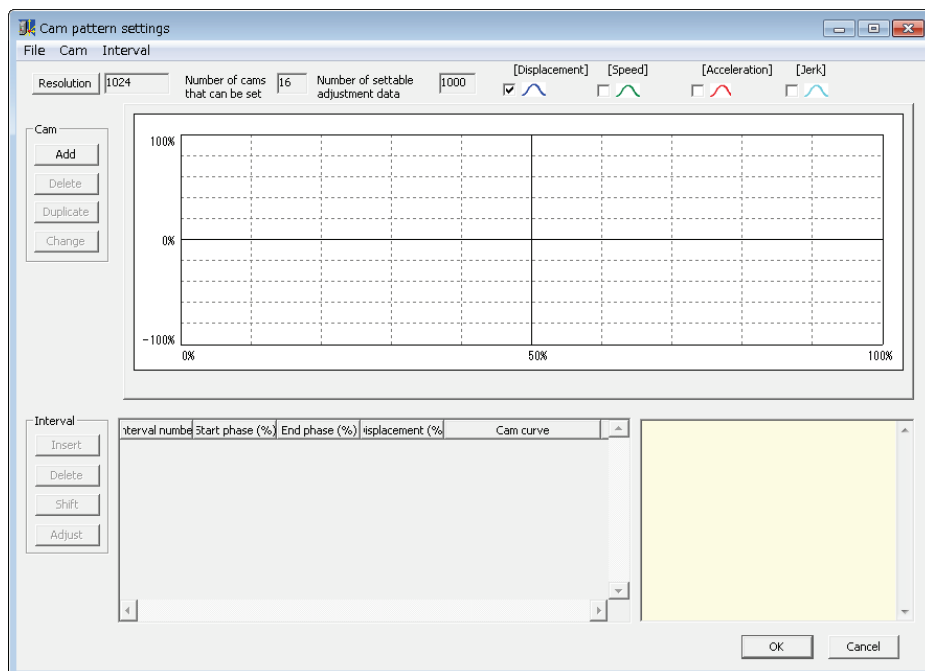

2. Set the necessary parameters according to the purpose and press [OK].
3. Select "File" → "Apply Setting" from the menu bar.

The parameters set in Configurator PM7 are applied as the project data being edited.



◆ REFERENCE

For setting of synchronous control parameters, please refer to "Chapter 12 Automatic Operation (Synchronous Control)".



◆ KEY POINTS

- The saved parameters can be read on the Configurator PM7.
- During synchronous control, basic input and output parameters will also operate according to "9.2 Parameter settings".

9.4 Creating Positioning Data Table

9.4.1 Structure of the position control data table

The Position Control Data table are assigned via the Configurator PM7. The following steps are performed with the Configurator PM7 that has been started as a premise.

■ Initial display of the Configurator PM7

- The form is assigned by each axis to set data tables.

The screenshot shows the 'Configurator PM7' window with a menu bar (File, Edit, View, Online, Debug, Axis Settings, Options, Help) and a toolbar. Below the toolbar, there are status indicators: 'Communications destination: Home', 'Position unit: pulse', and 'Speed unit: pulse / s'. The main area contains a table with the following data:

Table number	Operation pattern	Control method	X axis (1) mo...	Acceleratio...	Acceleration ...	De
1	E: End point	I: Increment	0	L: Linear	100	
2	E: End point	I: Increment	0	L: Linear	100	
3	E: End point	I: Increment	0	L: Linear	100	
4	E: End point	I: Increment	0	L: Linear	100	

■ Setting items

Parameter Name	Description
Operation pattern	Select any one of the following operation patterns. E-Point: trapezoid control of 1 data table C-Point: continuous trapezoid control E-point is specified at the end of C-point control. P-Point: continuous speed change control. E-point is specified at the end of P-point control. J-point: speed change) E-point is specified at the end of J-point control.
Control method	Select any one of the increment and the absolute values.
X-axis movement amount	Enter the movement of the X-axis. The movement unit system is specified via parameter setting.
Acceleration/ deceleration method	Select the acceleration/deceleration method.
Acceleration time (ms)	Set the acceleration time. Set the unit to ms.
Deceleration time (ms)	Set the deceleration time. Set the unit to ms.
Target speed	Set the target speed. Set the units to pps, $\mu\text{m/s}$, inch/s and rev/s.
Dwell time (ms)	Set the time from the completion of the positioning instruction in the E-point control until the operation done flag turns ON. The dwell time is the waiting time between data tables in the C-point control. In P-point control, the dwell time is ignored.
Auxiliary output	Set the auxiliary output code. When auxiliary output is enabled in parameter settings, the auxiliary output code set here will be outputted.
Comments	Any comment can be inputted in the data tables.

(Note 1): Details of parameter settings are displayed in the navigation bar.

(Note 2): When the interpolation control is selected, items like interpolation, Y-axis and Z-axis movements, X-axis auxiliary point, Y-axis auxiliary point, Z-axis auxiliary point and interpolation speed will also display.

9.4.2 Select type of position control data setting area

The position control data setting areas are classified into the 600-point standard area and the 89-point extension area with the features shown in the following table. Please use this function according to the applications.

■ Comparison between the standard area and the extension area

Item	Standard area	Extension area
Position control data table number	600 Data tables	89 Data tables
Data table No.	1-600	10001-10089
Position control parameters are set via the Configurator PM7 (note 1)	Optional	Optional
Position control data are set via the Configurator PM7 (note 2)	Optional The set data will be downloaded to the control unit along with programs and other file data. The position control data will be calculated to make the operations available to start when the power is turned on or the control unit enters the RUN mode.	Unavailable
Position control data are set by user program (Note 2)	Optional Send the data to the area of positioning memory via user program to send request for recalculation and make the operations available to start.	Optional Send the data to the area of positioning memory via user program to make the operations available to start. Recalculation request is not required.
Characteristics	Compared with using the extension area, starting by presetting the position control data via the Configurator PM7 is faster.	Compared with using the standard area, starting by setting the position control data via user program is faster.
Usage	Applications where position control data like movement and target speed are preset.	Applications where position control data change with the results of PLC operation.

(Note 1): Position control parameters mean JOG operation and home return conditions, limit input logic, deceleration time upon stop, etc.

(Note 2): Position control parameters mean movement, target speed, acceleration/deceleration time, running mode and other individual position control operation information.

■ Reconstruction calculation of standard area

After altering the position control data area with user program, reconstruction calculation (recalculation) is required. If no recalculation is conducted after altering the position control data tables with program, the position control data tables will operate as before the altering. The recalculation should follow the steps below.

1. Change the position control data table on the positioning memory
2. Set the recalculation signal (Y1107) of the I/O area to ON
3. Confirm the recalculation signal (X1107) of the I/O area and start any operation

9.4.3 Data table No. and position control startup

- The data table No. of the Configurator PM7 is specified via the F386 PSET instruction in the user program.
- After specifying the axis No. and data table No. with the F386 PSET instruction, when the corresponding position control starting point of is ON, execute control according to the settings in the data table.

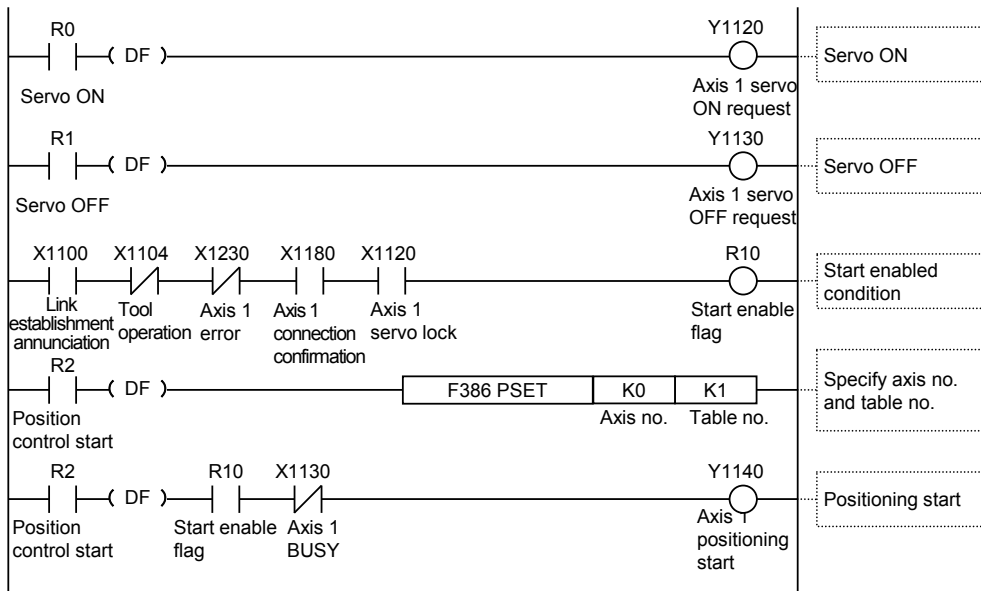

9.4.4 Running Mode and Data table

- Multiple data tables are used when the position control method is P-point control (speed change control), C-point control (continuance point control) or J-point control (JOG position control).
- When executing such controls, the data tables will be continuously created in the Configurator PM7, and select "E-point Control" for the operation pattern for the final data table.
- Specify the starting data table No. of each control in the program.

Eg.) During P-point control (speed change control)

Create 3 position control data tables and select "E: End Point" for the final data table. In addition, start the initial data table No. from the user program.

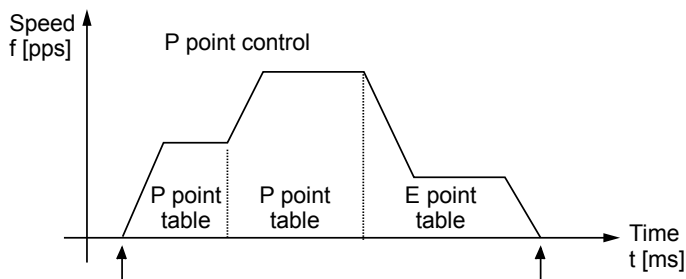

Table number	Operation pattern	Control method	X axis (1) mo...	Acceleratio...
1	P: Pass point	I: Increment	50000	L: Linear
2	P: Pass point	I: Increment	100000	L: Linear
3	E: End point	I: Increment	30000	L: Linear



◆ REFERENCE

For control details, please refer to "Chapter 11 Automatic Operation (Position Control)".

9.5 Saving and Managing Files

9.5.1 File Type

The set parameters and positioning table information can be saved or exported in the following three formats.

File name	Extension	Application	Operation of Configurator PM7
FPWIN GR7 project file	.fpx	Save parameters set by the Configurator PM7 together with programs and system registers as part of project data.	Apply Settings
Configurator PM7 file	.pm7r	Save parameters set by Configurator PM7 as files. The saved data can also be reused in multiple units and projects.	Save Setting Read Setting
CSV file	.csv	Export parameters set by Configurator PM7 in csv format. They can be used for checking parameters.	Export to CSV

9.5.2 Saving Parameters as Part of Project File

Parameters set by Configurator PM7 can be saved as part of project data. The following procedure is explained on the condition that the Configurator PM7 has already started.



◆ PROCEDURE

1. **Select "File" > "Apply Setting" from the menu bar.**
A confirmation message box is displayed.
2. **Press the [Yes] button.**
Parameters are saved as part of the project data being edited on the FPWIN GR7.
3. **Select "File" > "Exit" from the menu bar.**
It returns to the base screen of FPWIN GR7.
4. **Select "Project" > "Save As" from the FPWIN GR7 menu bar.**
The "Save As" dialog box is displayed.
5. **Enter a saving destination and file name, and press [Save] button.**
The parameters are saved as a FPWIN GR7 project file (extension (.fpx)).

9.5.3 Saving Parameters as Parameter File

Parameters set by Configurator PM7 can be saved as a file. The following procedure is explained on the condition that the Configurator PM7 has already started.



◆ PROCEDURE

1. **Select "File" > "Save Settings" from the menu bar.**

The "Save As" dialog box is displayed.

2. **Enter the save path and file name, and press [Save].**

Parameter information and position control data table information are saved as files with an extension (.pm7r).



◆ KEY POINTS

- **The files saved by the above operations contain the information on all parameters and positioning tables set on the Configurator PM7. The information can be read by selecting "File" > "Read Setting" of the Configurator PM7 menu.**

9.5.4 Exporting Parameters to CSV Files

The information on set parameters and positioning tables can be exported in csv format. It is possible to open the csv files and check the settings of each parameter and positioning table.



◆ PROCEDURE

1. Select "File" > "Export to CSV" from the menu bar.

The "Export to CSV" dialog box is displayed.

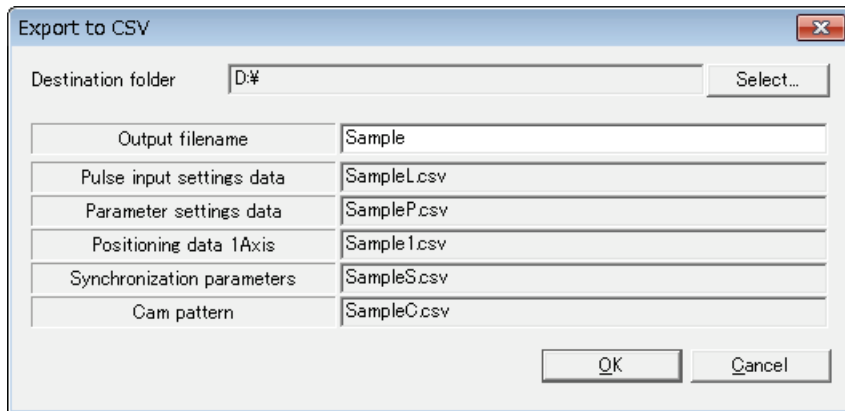

2. Enter a file name, and press the [OK] button.

CSV files with given file names are saved for each parameter.

10

Transfer to Unit and Commissioning

10.1 Check on Settings

10.1.1 Data Check of Parameters

The following procedure is explained on the condition that the Configurator PM7 has already started.



◆ PROCEDURE

1. Select "Debug" → "Check Parameters and Data Values" from the menu bar.

A message box will be displayed to show the check result. If there is an error in the settings for the positioning data tables, an error message will appear and the cursor will move to the corresponding error position.

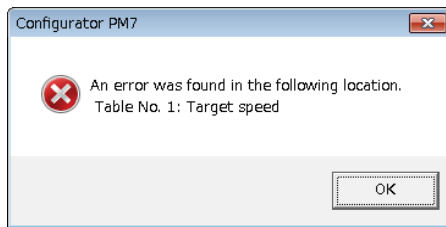

10.1.2 Comparison of Parameter information

It is possible to compare information on parameters being edited with information saved in the Configurator PM7. The following procedure is explained on the condition that the Configurator PM7 has already started.



◆ PROCEDURE

1. **Select "Debug" → "Verify" → "File" or "PLC" from the menu bar.**

After selecting the file, the "Select a file to verify" dialog box appears. After selecting PLC, the parameters being edited and configuration information saved in the PLC can be compared in Configurator PM7, and then the results are displayed.

2. **Select the file from the "Select a file to verify" dialog box and click the [OK] button.**

Compare the parameters being edited and configuration information saved in the PLC in Configurator PM7, and then display the results.

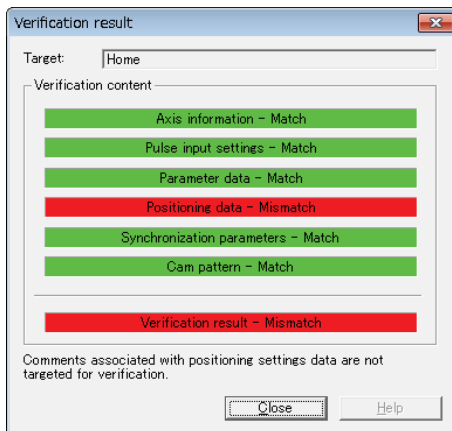

10.2 Transfer of parameters

10.2.1 Download by FPWN GR7

- Information on parameters that have been set is transferred as part of project information to the control unit along with programs and system registers. The following steps are performed with the Configurator PM7 that has been started as a premise.



◆ PROCEDURE

1. Select "File"→"Exit" from the Configurator PM7 menu bar.
2. "Setting data will be applied. Are you sure you want to proceed?" After a message appears, click [Yes (Y)].

The parameters set on the Configurator PM7 are applied to the project being edited, and the screen returns to the base screen of the FPWIN GR7.

3. Select "Online"→"Download to PLC" (Entire Project) from the menu bar.

A confirmation message dialog box is displayed.

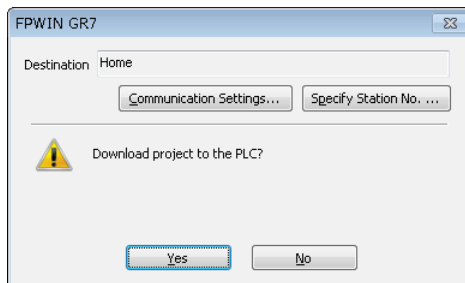

4. Press the [Yes] button.

Downloading the project is executed. A message dialog box to confirm whether to switch the mode or not is displayed.

5. Press the [Yes] or [No] button.

Press [Yes] to change to the RUN mode. [Press [No] to continue the PROG. mode. When changing the RUN mode, the configuration information is valid in the unit, and the test run using I/O signals or the Configurator PM7 can be performed.

6. Select "Options"→"Positioning Table Settings" from the menu bar.

Configurator PM7 is started. Select [Online]→[Data Monitor], [Status Display], [Tool Operation] to enter the status available to execute different menus of the unit.

10.2.2 Download by Configurator PM7

In the case of FP-XH M8N Control Unit, parameters and information data can be downloaded or uploaded on the Configurator PM7. The following procedure is explained on the condition that the Configurator PM7 has already started.



◆ PROCEDURE

1. Select **"File" > "Write PLC"** from the menu bar of the Configurator PM7.

A confirmation message box is displayed.

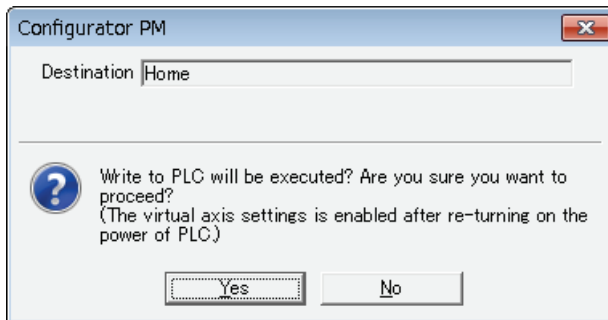

2. Press the **[Yes]** button.

The positioning parameters are downloaded to the control unit. A message dialog box to confirm whether to switch the mode or not is displayed.

3. Press the **[Yes]** or **[No]** button.

Press [Yes] to change to the RUN mode. Press [No] to continue the PROG. mode. When changing the RUN mode, the configuration information is valid in the unit, and the test run using I/O signals or the Configurator PM7 can be performed.

4. Select **"Options" > Positioning Table Settings"** in the menu bar.

The Configurator PM7 is activated. Select [Online] > [Data monitor] > [Status display] > [Tool operation] so that each menu items of the unit will be available.



◆ KEY POINTS

- When the download is performed on the Configurator PM7, the positioning parameters saved in the F-ROM of the control unit will also be overwritten. Save the projects as files as necessary.

10.3 Monitoring on Configurator PM7

10.3.1 Status Monitor

The connection state of each axis and input state of external terminals can be monitored. The following procedure is explained on the condition that Configurator PM7 has already started.



◆ PROCEDURE

1. Select "Online" → "Status Display" from the menu bar.

The "Status monitor" dialog box is displayed.

Model	FP-XH RTEX 8-Axis Type			
Axis [Group]	V-Axis1	Axis 1	Axis 2	Axis 3
Connection status	Connected	Connected	Connected	Not connected
Brand name	-----	Panasonic	Panasonic	-----
Amp model code	-----	MADHT1505NA1	MADHT1505NA1	-----
Motor model code	-----	MSME5A2G1S	MSME5A2G1S	-----
Status display				
Servo free	Lock	Lock	Free	-----
Status	Stopped	Operating	Stopped	-----
Completion width	Out of range	Out of range	Within range	-----
External terminal input monitor				
Home position proximity	-----	OFF	OFF	-----
Limit +	-----	Limit +	Limit +	-----
Limit -	-----	Limit -	Limit -	-----
◀ ▶				
Firmware version	1.00			
Hardware version	1.00			
Help Close				

■ Monitoring items

Item	Description	Related page
Model	Displays the model name of the FP-XH M8N Control Unit.	
Axis [Group]	Indicates the axis numbers. For interpolation axes, the group names are also displayed such as [A], [B], [C] and [D].	
Connection status	Displays the state whether the network is established or not, and whether the communication between the control unit and servo amplifiers are performed properly or not. "Connected" (green): The communication is performed. "Not connected" (gray): The communication is not performed.	
Brand name	Displays the servo amplifiers, motors' brand names, AMP model codes and motor model codes.	
AMP model code		
Motor model code		
Status display		
servo free	Displays the servo-locked/free state. "Lock" (green): Indicates that the servo is locked. "Free" (gray): Indicates that the servo is free.	
Status	Displays the operation state of each axis. "Operating" (green): The motor is running. "Stopped" (gray): The motor stops. "-----" (gray): No motor is connected.	
Completion width	Displays the state whether the deviation counter is in the imposition range or not. "Within range" (green): It is in the imposition state. "Out of range" (gray): It is not in the imposition state.	
External input terminal monitor		
Home position proximity	Displays the input state of the near home and limit inputs connected to the servo amplifiers. "Home position proximity" (green): The near home input is ON (valid). "Limit +" (green): The limit + input is ON (valid). "Limit -" (green): The limit + input is ON (valid). "OFF" (gray): The above inputs are OFF (invalid).	
Limit +		
Limit -		
Firmware version	Displays the firmware version and, hardware version of the FP-XH M8N Control Unit and motion control part.	
Hardware version		

The input logics of the near home, limit + and limit - inputs depend on the settings of servo amplifiers.

10.3.2 Data Monitor

The connection state of each axis and input state of external terminals can be monitored. The following procedure is explained on the condition that Configurator PM7 has already started.



◆ PROCEDURE

1. Select "Online" → "Data Monitor" from the menu bar.

The "Data monitor" dialog box is displayed.

Axis [Group]	V-Axis1	Axis 1	Axis 2	Axis 3
Synchronous master axis	Master	-----	-----	V-Axis1
Synchronized output	-----	-----	-----	Gear + Clutch + Cam
Synchronous state	Synchronous	Asynchronous	Asynchronous	Synchronous
Table number executing	0	0	0	0
Auxiliary output code	0	0	0	0
Amp current value (Pulse)	-43305	5578	112	-1
Unit conversion current value	-43305 pulse	5578 pulse	112 pulse	-1 pulse
Torque command(%)	-----	1.2	0.0	-0.1
Actual speed (rpm)	-----	0	0	0
Deviation	-----	-1	0	1
Axis state	Operating	Stopped	Error	Operating
Error code	-----	-----	00000-E3000	-----
	<input type="button" value="Clear errors"/>	Clear errors	Clear errors	Clear errors
Warning code	-----	00000-EB010	-----	-----
	Clear warning	Clear warning	Clear warning	Clear warning

■ Item monitoring

Item	Description	Related Page
Synchronous master axis	When set as the master axis, "Main Station" will be displayed. When set as the slave axis, the master axis based on such axis will be displayed. E.g.) When axis-2 is set to be a slave following axis-1 as the main station, "axis-1" will be displayed in the line of axis-2". Axes not used for synchronized control will be displayed as [-----].	12.1 Synchronous Control
Synchronize output	Displays the synchronous running function set to the slave axis. Gear, clutch, cam Gear+Clutch, Gear+Cam, Clutch+Cam Gear+Clutch+Cam Axes not used for master axis and synchronized control will be displayed as [-----].	
Synchronous state	Displays the set status (synchronous/non-synchronous) of each axis.	
Table number executing	No. of data tables being executed or executed by position control data	9.4 Creating Positioning Data Table
Auxiliary output code	When auxiliary output is enabled, the output codes are outputted within the scope of 0-65536.	17.3 Auxiliary Output
Amp current value	Displays the feedback pulse value of the servo amplifier. It returns to "0" on the completion of home return.	17.4 Coordinate 17.5 Current Value Update
Unit conversion current value	Displays the feedback pulse value after the unit conversion of the servo amplifier. It returns to "0" on the completion of home return. When the home coordinate has been set, it will be preset to the home coordinate on the completion of home return.	
Torque command (%)	Monitors the torque command value of the servo amplifier.	17.10 Monitor Error (Torque / Actual Speed Judgement)
Actual speed (rpm)	Monitors the actual speed of the servo amplifier.	
Deviation	Monitors the deviation between the current position managed in the control unit and the AMP current position fed back from the AMP.	17.12 Position Deviation Simple Monitor
Axis state	Displays the operation state of each axis. "Operating" (green): The motor is running. "Stopped" (gray): The motor stops. "Error" (red): An error occurs.	
Error code	The latest error code is displayed in case of an error. Click [Clear errors] to remove the error.	19.3 Table of Error Codes
Warning code	The latest warning code is displayed in case of a warning. Click [Clear warning] to clear the warning.	19.4 Table of Warning Codes



◆ NOTES

- Click [Clear errors] to clear the error upon recoverable error of the control unit.
- Click [Clear warning] to clear the warning upon warning of the control unit.

10.4 Tool Operation

10.4.1 Tool Operation Function

- You can perform commissioning with the Configurator PM7 before actually starting the user program.
- Be sure to save the settings and download the project to the control unit before starting the tool operation of the positioning unit.
- The following procedure is explained on the condition that the Configurator PM7 has already started.



◆ PROCEDURE

1. Select "Online" → "Tool Operation" from the menu bar.

The "Tool Operation" dialog box is displayed.

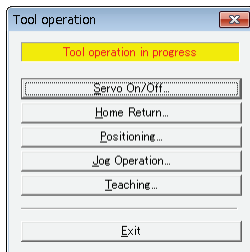

■ Types of tool operation

Item	Description
Servo ON/OFF	Controls servo ON/OFF of each axis.
Home return	A home return is performed to the home of the machine coordinates according to the specified parameter.
Positioning	Moves from the start table number according to the set contents of the positioning table.
JOG operation	The specified axis can be moved to the specified direction at the specified speed while the operation command is on.
Teaching	Controls the axis manually like JOG operation, and reflects the resulting positioning address on the data editing screen.



◆ KEY POINTS

- The unit cannot go into the tool operation while the unit is operated with a user program.
- Operation requests with I/O signals will be disabled while the positioning unit is in tool operation.
- If any communication error occurs during the tool operation, the control unit will detect the error and stop automatically.
- If the previous tool operation did not finish properly due to a communication error, etc., the tool operation mode will be cancelled forcibly when the next tool operation starts.

10.4.2 Servo ON/OFF with Tool Operation Function

The following procedure is explained on the condition that the Configurator PM7 has already started.



◆ PROCEDURE

1. Select "Online" → "Tool Operation" from the menu bar.

The "Tool Operation" dialog box is displayed.

2. Select "Servo ON/OFF" from the "Tool Operation" dialog box.

The "Servo ON/OFF" dialog box is displayed.

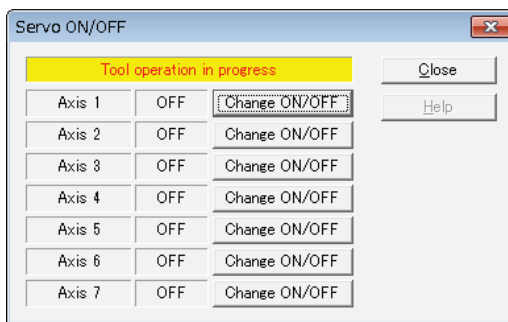

3. Press the [ON/OFF] button of any axis.

The Servo ON/Servo OFF status is switched.

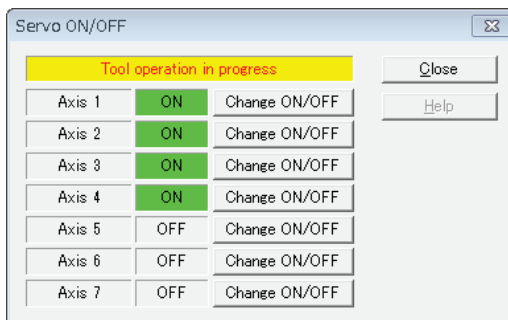

4. Confirm the Servo ON/OFF of any axis and press the [Close] button.

It returns to the "Tool Operation" dialog box.



◆ KEY POINTS

- If the servo ON/OFF has been controlled using ladder programs, the servo-lock or servo-free state before the start of the tool operation is kept and the operation shifts to the tool operation.
- The servo-lock or servo-free state before the completion will be kept even after finishing the tool operation mode.

10.4.3 JOG Operation with Tool Operation Function

You can perform commissioning with the Configurator PM7 before actually starting the user program. The following procedure is explained on the condition that the Configurator PM7 has already started.



◆ PROCEDURE

1. Select "Online" → "Tool Operation" from the menu bar.

The "Tool Operation" dialog box is displayed.

2. Select "JOG operation" from the Tool Operation dialog box.

The "Tool operation – Jog operation" is displayed.

Tool operation in progress				
Axis [Group]	V-Axis 1	Axis 1	Axis 2	Axis 3
Synchronous master axis	Master	-----	-----	V-Axis 1
Synchronized output	-----	-----	-----	Gear + Clutch + Cam
Synchronous state	Synchronous	Asynchronous	Asynchronous	Synchronous
	Change synchronization	Change synchronization	Change synchronization	Change synchronization
Current value	0	1008	7	1
	Current value update	Current value update	Current value update	Current value update
Unit	pulse	pulse	pulse	pulse
Jog target speed	1000	1000	1000	1000
	Change	Change	Change	Change
JOG	+ -	+ -	+ -	+ -
Axis state	Stopped	Operating	Stopped	Error
Error code	-----	-----	-----	00000-E3000
	Clear errors	Clear errors	Clear errors	Clear errors
Warning code	-----	-----	-----	-----
	Clear warning	Clear warning	Clear warning	Clear warning
Speed Rate	100 %			Help Exit

3. Press the [+] or [-] button in the field of JOG.

It executes JOG operation.

4. Press [Exit] button to terminate the JOG operation.



◆ KEY POINTS

- This dialog box cannot be closed during the operation.

■ Dialog box items

Item	Description	Related Page
Synchronous master axis	When set as the master axis, "Master" will be displayed. When set as the slave axis, the master axis based on such axis will be displayed. E.g.) When the axis 2 is set to be a slave following the axis 1 as the master, "Axis 1" will be displayed in the line of Axis 2". Axes not used for synchronized control will be displayed as [-----].	12.1 Synchronous Control
Synchronized output	Displays the synchronous running function set to the slave axis. Gear, clutch, cam Gear+Clutch, Gear+Cam, Clutch+Cam Gear+Clutch+Cam Axes not used for master axis and synchronized control will be displayed as [-----].	
Synchronous state	Displays the set status (synchronous/non-synchronous) of each axis. Pressing the "Change synchronization" button switches the state between Synchronous and Asynchronous.	
Current value	Monitors the feedback values of various axes after unit conversion. Press the [Update Current Value] button to display the value input dialog box, which allows change of the current value.	17.5 Current Value Update
Unit	Displays the unit of the position command of each axis set in parameter settings.	
JOG target speed	Monitors and displays the target speed of JOG operation. Click the [Change] button to change the target speed of JOG operation.	13.1 Setting and Operation of JOG Operation
JOG [+]	Click the [+] button to execute JOG forward running.	
JOG [-]	Click the [-] button to execute JOG backward running.	
Axis state	Displays the operation state of each axis. "Operating" (green): The motor is running. "Stopped" (gray): The motor stops. "Error" (red): An error occurs.	
Error code	The latest error code is displayed in case of an error. If a recoverable error occurs in the control, click the [Clear errors] button to clear the error.	19.3 Table of Error Codes
Warning code	The latest warning code is displayed in case of a warning. Click [Clear warning] to clear the warning.	19.4 Table of Warning Codes
Speed rate	It allows setting the target speed of JOG operation of different axes set in parameter settings as 100% to specify the speed multiplier operation. Click the [Speed Rate] button to display the value input dialog box.	

10.4.4 Home Return by Tool Operation Function

- When the power is turned on, the coordinates of the control unit do not coincide with those of the machine position. Execute a home return before starting positioning.
- You can perform commissioning with the Configurator PM7 before actually starting the user program..
- The following procedure is explained on the condition that the Configurator PM7 has already started.



◆ PROCEDURE

1. Select "Online" → "Tool Operation" from the menu bar.

The "Tool Operation" dialog box is displayed.

2. Select "Home Return" from the Tool Operation dialog box.

The "Tool operation - Return to home position " dialog box is displayed.

Tool operation in progress				
Axis [Group]	V-Axis 1	Axis 1	Axis 2	Axis 3
Synchronous master axis	Master	-----	-----	V-Axis 1
Synchronized output	-----	-----	-----	Gear + Clutch + Cam
Synchronous state	Synchronous	Asynchronous	Asynchronous	Synchronous
	Change synchronization	Change synchronization	Change synchronization	Change synchronization
Current value	0	902	14	2
	ome position coordinate	ome position coordinate	ome position coordinate	ome position coordinate
Unit	pulse	pulse	pulse	pulse
Home return mode	Data set method	Dog method 1	Dog method 1	Dog method 1
	Start	Stop	Start	Start
Axis state	Stopped	Operating	Stopped	Error
Error code	-----	-----	-----	00000-E3000
	Clear errors	Clear errors	Clear errors	Clear errors
Warning code	-----	-----	-----	-----
	Clear warning	Clear warning	Clear warning	Clear warning
Speed Rate	100 %			Help Exit

3. Click the [Start] button of the axis to be subject home return.

It executes home return.

4. Press [Exit] button to terminate the home return operation.



◆ KEY POINTS

- This dialog box cannot be closed during the operation.

■ Dialog box items

Item	Description	Related Page
Synchronous master axis	When set as the master axis, "Master" will be displayed. When set as the slave axis, the master axis based on such axis will be displayed. E.g.) When the axis 2 is set to be a slave following the axis 1 as the master, "Axis 1" will be displayed in the line of Axis 2". Axes not used for synchronized control will be displayed as [-----].	12.1 Synchronous Control
Synchronized output	Displays the synchronous running function set to the slave axis. Gear, clutch, cam Gear+Clutch, Gear+Cam, Clutch+Cam Gear+Clutch+Cam Axes not used for master axis and synchronized control will be displayed as [-----].	
Synchronous state	Displays the set status (synchronous/non-synchronous) of each axis. Pressing the "Change synchronization" button switches the state between Synchronous and Asynchronous.	
Current value	Displays the current value of the axes after unit conversion. Click [Home position coordinate] to display the value input dialog box to change the value after home return.	17.4 Coordinate 17.5 Current Value Update
Unit	Displays the unit of the position command of each axis set in parameter settings.	
Home return mode	Displays the content of the home return setting code registered in the positioning setting data.	14.1 Type of Home Return
Start/stop	Executes Start/Stop operation of origin ·Click the [Start] button to execute home return, and the button name is changed to [Stop]. ·Press the [Stop] button to execute deceleration stop, and the button name is changed to [Stop].	
Axis state	Displays the operation state of each axis. "Operating" (green): The motor is running. "Stopped" (gray): The motor stops. "Error" (red): An error occurs.	
Error code	The latest error code is displayed in case of an error. If a recoverable error occurs in the control, click the [Clear errors] button to clear the error.	19.3 Table of Error Codes
Warning code	The latest warning code is displayed in case of a warning. Click [Clear warning] to clear the warning.	19.4 Table of Warning Codes
Speed rate	It allows setting the target speed of home return of different axes set in parameter settings as 100% to specify the speed multiplier operation. Click the [Speed rate] button to display the value input dialog box.	

10.4.5 Positioning by Tool Operation Function

Specifying a starting table number enables to check if positioning from the starting table operates properly.



◆ PROCEDURE

1. Select "Online" → "Tool Operation" from the menu bar.

The "Tool Operation" dialog box is displayed.

2. Select "Positioning" from the "Tool Operation" dialog box.

The "Tool operation – Positioning" dialog box is displayed.

Axis [Group]	V-Axis1	Axis 1	Axis 2	Axis 3
Synchronous master axis	Master	-----	-----	V-Axis1
Synchronized output	-----	-----	-----	Gear + Clutch + Cam
Synchronous state	Synchronous	Asynchronous	Asynchronous	Synchronous
	Change synchronization	Change synchronization	Change synchronization	Change synchronization
Current value	0	119325	9	-1
	Current value update	Current value update	Current value update	Current value update
Unit	pulse	pulse	pulse	pulse
Table number executing	-----	1	-----	-----
Start table number	1	1	1	1
	Change	Change	Change	Change
	Operation	Stop	Operation	Operation
Axis state	Stopped	Operating	Stopped	Error
Error code	-----	-----	-----	00000-E3000
	Clear errors	Clear errors	Clear errors	Clear errors
Warning code	-----	-----	-----	-----
	Clear warning	Clear warning	Clear warning	Clear warning
Speed Rate	100 %			
	Help		Exit	

3. Press the [Change] button under the target start table number field.

The starting table no. setting dialog box is displayed.

4. Enter the starting table number.

5. Press the [Operation] button.

Positioning starts from the specified start table number.

6. Press [Exit] button to terminate the positioning operation.

■ Dialog box items

Item	Description	Related Page
Synchronous master axis	When set as the master axis, "Master" will be displayed. When set as the slave axis, the master axis based on such axis will be displayed. E.g.) When the axis 2 is set to be a slave following the axis 1 as the master, "Axis 1" will be displayed in the line of Axis 2". Axes not used for synchronized control will be displayed as [-----].	12.1 Synchronous Control
Synchronized output	Displays the synchronous running function set to the slave axis. Gear, clutch, cam Gear+Clutch, Gear+Cam, Clutch+Cam Gear+Clutch+Cam Axes not used for master axis and synchronized control will be displayed as [-----].	
Synchronous state	Displays the set status (synchronous/non-synchronous) of each axis. Pressing the "Change synchronization" button switches the state between Synchronous and Asynchronous.	
Current value	Monitors the feedback values of the axes after unit conversion. Click the [Current value update] button to display the value input dialog box, which allows to update the current value.	17.5 Current Value Update
Unit	Displays the unit of the command of each axis set in parameter settings.	
Table number executing	Displays the table number during the operation or when it completes.	9.4 Creating Positioning Data Table
Start table number	Start table No. of position control Click the [Change] button to change the start table no. .	
Operation/Stop	Operates/stops operation of position control <ul style="list-style-type: none"> Click the [Operation] button to execute position control, and the button name is changed to [Stop]. Press the [Stop] button to execute deceleration stop, and the button name is changed to [Operation]. 	
Axis status	Displays the operation state of each axis. "Operating" (green): The motor is running. "Stopped" (gray): The motor stops. "Error" (red): An error occurs.	
Error code	The latest error code is displayed in case of an error. If a recoverable error occurs in the control, click the [Clear errors] button to clear the error	19.3 Table of Error Codes
Warning code	The latest warning code is displayed in case of a warning. Click [Clear warning] to clear the warning.	19.4 Table of Warning Codes
Speed rate	It allows setting the target speed of JOG operation of different axes set in parameter settings as 100% to specify the speed multiplier operation. Click the [Speed Rate] button to display the value input dialog box.	



◆ **KEY POINTS**

- For the positioning operation, the setting data should be downloaded to the control unit in advance. The operations after the starting table number vary depending on operation patterns.
- The positioning operation of the interpolation group starts and stops the axis with the smallest number in the group. In the case of the tool operation function, the positioning operation starts by pressing the "Operate" button of any axes, however, a warning message is displayed when the "Operate" button other than that for the smallest axis number is pressed.
- This dialog box cannot be closed during the operation.
- When conditions are changed during the tool operation, the positioning memory will be updated temporarily and the operation will be performed, however, the changed conditions will not be reflected in the configuration data written in the control unit. Therefore, when the mode is changed to the RUN mode again, the unit will start based on the configuration data downloaded to the control unit.

10.4.6 Teaching by Tool Operation Function

Activate each axis manually by the tool operation, and register the positioning addresses where each axis stops as the point data.



◆ PROCEDURE

1. Select "Online" → "Tool Operation" from the menu bar.

The "Tool Operation" dialog box is displayed.

2. Select "Teaching" from the Tool Operation dialog box.

The "Tool operation – Teaching" dialog box is displayed.

Tool operation in progress				
Axis [Group]	V-Axis 1	Axis 1	Axis 2	Axis 3
Synchronous master axis	Master	-----	-----	V-Axis 1
Synchronized output	-----	-----	-----	Gear + Clutch + Cam
Synchronous state	Synchronous	Asynchronous	Asynchronous	Synchronous
	Change synchronization	Change synchronization	Change synchronization	Change synchronization
Current value	0	2014	9	-1
	Current value update	Current value update	Current value update	Current value update
Unit	pulse	pulse	pulse	pulse
Jog target speed	1000	1000	1000	1000
	Change	Change	Change	Change
JOG	+ -	+ -	+ -	+ -
Table number	1	1	1	1
	Teaching	Teaching	Teaching	Teaching
Axis state	Stopped	Operating	Stopped	Error
Error code	-----	-----	-----	00000-E3000
	Clear errors	Clear errors	Clear errors	Clear errors
Warning code	-----	-----	-----	-----
	Clear warning	Clear warning	Clear warning	Clear warning
Speed Rate	100 %			
	Help		Exit	

3. Stop at the positioning point by the JOG operation.
4. Press the [Teaching] button.
5. Enter the table number where the desired positioning information is registered, and click the [OK] button.

The current value is registered for the amount of movement of the table number specified. Also, if the axis that the teaching operation is performed is an interpolation axis, the current value is registered for the movement amount of the equivalent coordinate in the interpolation group.

6. Press [Exit] button to terminate the teaching operation.

■ Dialog box items

Item	Description	Related Page
Synchronous master axis	When set as the master axis, "Master" will be displayed. When set as the slave axis, the master axis based on such axis will be displayed. E.g.) When the axis 2 is set to be a slave following the axis 1 as the master, "Axis 1" will be displayed in the line of Axis 2". Axes not used for synchronized control will be displayed as [-----].	12.1 Synchronous Control
Synchronized output	Displays the synchronous running function set to the slave axis. Gear, clutch, cam Gear + Clutch, Gear + Cam, Clutch + Cam Gear + Clutch + Cam Axes not used for master axis and synchronized control will be displayed as [-----].	
Synchronous state	Displays the set status (synchronous/non-synchronous) of each axis. Pressing the "Change synchronization" button switches the state between Synchronous and Asynchronous.	
Current value	Monitors the feedback values of the axes after unit conversion. Click the [Current value update] button to display the value input dialog box, which allows to update the current value.	17.5 Current Value Update
Unit	Displays the unit of the command of each axis set in parameter settings.	
JOG target speed	Monitors and displays the target speed of JOG operation. Click the [Change] button to change the target speed of JOG operation.	13.1 Setting and Operation of JOG Operation
JOG [+]	Click the [+] button to execute JOG forward running.	
JOG [-]	Click the [-] button to execute JOG backward running.	
Table no.	Displays the table no. of teaching an press the [Teaching] button to change the data table No. of teaching and register the current value.	9.4 Creating Positioning Data Table
Axis state	Displays the operation state of each axis. "Operating" (green): The motor is running. "Stopped" (gray): The motor stops. "Error" (red): An error occurs.	
Error code	The latest error code is displayed in case of an error. If a recoverable error occurs in the control, click the [Clear errors] button to clear the error.	19.3 Table of Error Codes
Warning code	The latest warning code is displayed in case of a warning. Click [Clear warning] to clear the warning.	19.4 Table of Warning Codes
Speed rate	It allows setting the target speed of home return of different axes set in parameter settings as 100% to specify the speed multiplier operation. Click the [Speed Rate] button to display the value input dialog box.	



◆ KEY POINTS

- The control method for the table number that the teaching operation was performed is automatically changed to "Absolute".
- The result of the teaching becomes effective once the tool operation quits and the setting data is downloaded to the control unit.
- This dialog box cannot be closed during the operation.

10.5 Monitoring Current Value with Program

10.5.1 Current Value Area

- They are stored as 2-word 32-bit data in the axis information area of positioning memory.
- The elapsed value area will be reset when the power supply turns off. It will be held when switching the mode from RUN to PROG.

■ Counting range of the elapsed value (current value) area

Division	Range
Independent axis control	-2,147,482,624~2,147,482,624
Interpolation axis control	-8,388,608-+8,388,607

10.5.2 Reading of the current value

Perform reading according to the reading instruction for the [F384 PTBLR] position control parameters.

■ Instruction Format



Operand	Settings	Specify reading of the elapsed value area	
S1	Specify the axis number and positioning memory area	H1	Specify the axis information area of axis 1
		H101	Specify the axis information area of axis 2
		H201	Specify the axis information area of axis 3
		H301	Specify the axis information area of axis 4
		H401	Specify the axis information area of axis 5
		H501	Specify the axis information area of axis 6
		H601	Specify the axis information area of axis 7 (or virtual)
		H701	Specify the axis information area of axis 8 (or virtual)
S2	Saves the starting address of the positioning memory (offset address)	H3C	Current value (Pulse)
		H3E	Unit converted into the current value (pulse/μm/inch/degree)
n	Read the number of words	K2	Specify the word 2
D	Save the operation memory of the read data	Specify any memory.	

■ **Sample program**

It represents the situation when axis-4 elapsed value (current value) is read into the data registers DT300-DT301. For details about the instructions, please refer to "Chapter 18 Instruction Reference".

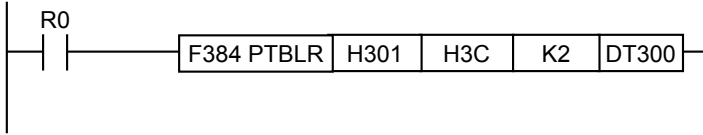

■ **Current value and unit converted into the current value**

Offset Address	Description
H3C	Unit: Pulse The current value based on the mechanical origin and is saved in the unit of pulse. reset to "0" upon home return. The value will not be updated even if the Update Current Value function is executed.
H3E	Unit: pulse/ μ m/inch/degree Saves the current value based on the electrical origin. Save the value converted to the selected unit system (pulse, μ m, inch and degree) in the setting area of different axes. After home return, the values set as the coordinate origin will be saved. It will be reset to "0" when the value saved in the coordinate origin is "0". This area will be updated when using the Update Current Value function.

11

Automatic Operation (Position Control)

11.1 Basic Operations

11.1.1 Position Control Method

■ Operation pattern

(A: Available)

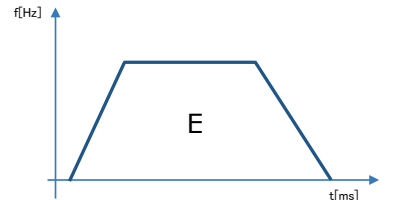
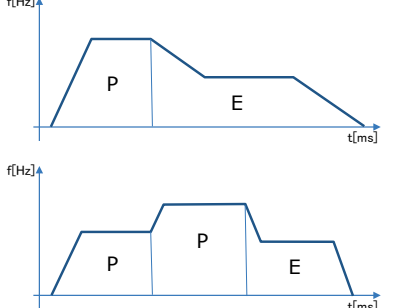
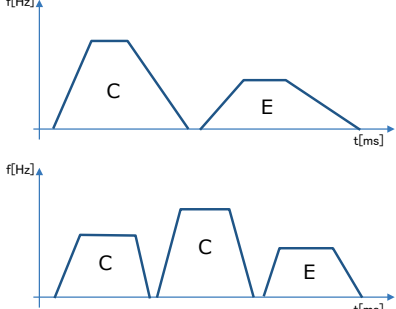
Name	Timing charts	Actions and Purposes	Repe- tition	Interpo- lation
E-point Control		<ul style="list-style-type: none"> ● Moving to the end point is called "E-point Control". ● Use this method for the 1-speed acceleration and deceleration control. 	A	A
P-point Control		<ul style="list-style-type: none"> ● Controlling via the pass point is called "P-point Control". ● Use this method for the 2-speed acceleration and deceleration control. ● When the P-point control is started, it will be switched to the E-point control after the pulse output is performed based on the specified movement amount. 	A	A
C-point Control		<ul style="list-style-type: none"> ● Controlling via the continuance point is called "C-point Control". ● Use this method for two continuous 1-speed position controls corresponding to the target speed, acceleration and deceleration time. ● The time switching to the E-point control from the C-point control is specified as the dwell time. 	A	A

Name	Timing Charts	Actions and Purposes	Repetition	Interpolation				
J-point Control	<p>No Speed Change</p>	<ul style="list-style-type: none"> Controlling via the speed point (JOG Operation Point) is called "J-point Control". Perform control at the set speed after startup. Start the position control when the J-point position control contact is in ON. Change speed when the J-point speed change flag is set <table border="1"> <tr> <td>①</td> <td>Position control contact of Point J</td> </tr> <tr> <td>②</td> <td>Speed change flag of Point J</td> </tr> </table>	①	Position control contact of Point J	②	Speed change flag of Point J	—	—
	①		Position control contact of Point J					
②	Speed change flag of Point J							
<p>Speed Change</p>								

■ Selection of the position control operation pattern

Select the position control operation pattern with the Configurator PM7.

- Enter the mode in 1 line of the E-point control.
- During continuous input of data tables with P point control, C point control and J point control, executes combined input to make the final data table adopt E-point control.

Table number	Operation pattern	Control method	X axis (1) mo...	Acceleratio...	Acceleration ...	Deceleration ti...	Target s...	Dwell time ...	Auxiliary...
1	P: Pass point	I Increment	50000	L: Linear	80	100	200000	0	0
2	P: Pass point	I Increment	100000	L: Linear	100	100	300000	0	0
3	E: End point	I Increment	30000	L: Linear	100	100	100000	0	0
4	C: Continuance p...	I Increment	50000	L: Linear	100	100	50000	0	0
5	P: Pass point	I Increment	20000	L: Linear	100	100	100000	0	0
6	E: End point	I Increment	10000	L: Linear	100	100	200000	0	0
7	J: Speed point	I Increment	0	L: Linear	100	100	10000	0	0
8	E: End point	I Increment	100000	L: Linear	100	100	200000	0	0
9	E: End point	I Increment	0	L: Linear	100	100	1000	0	0



◆ KEY POINTS

- When using P: passing point, C: continuance point, J: the next line of the speed point is not selected and E: end point, detect the self-diagnostic error.

■ Setting the J-point control

- Only select the "Increment" with the J-point control.
- Set the changed target speed in the dialog box of the position control parameters for the speed change with the J-point control.

11.1.2 Setting and Operation of E-point Control

The following example is explained with the independent axis control of axis-1. Set the movement amount as the increment mode and the unit as pulse.

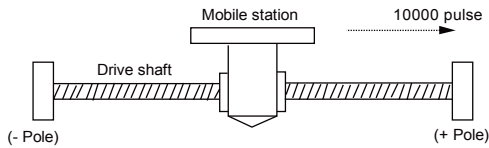

■ Settings

Item	Setting Example
Operation pattern	E: end point
Control method	I: increment
X-axis movement amount	10,000 pulse
Acceleration/deceleration method	L: linear
Acceleration time (ms)	100 ms
Deceleration time (ms)	100 ms
Target speed	10000 pps

■ Operation diagram

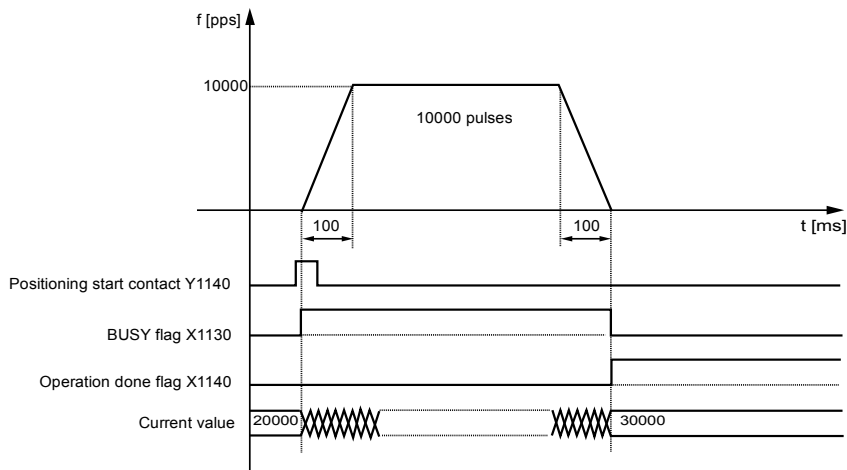

■ Operation of each contact

- The BUSY flag (X1130), which indicates that the motor is running, will turn ON when the positioning control starts, and it will turn OFF when the operation completes.
- The operation done flag (X1140), which indicates the completion of operation, will turn ON when the current operation is completed, and it will be held until the next positioning control JOG operation, home return, or pulse operation starts. The flag will turn ON after the unit transmits a reference for the target position.

11.1.3 Setting and Operation of P-point Control

The following example is explained with the independent axis control of axis-1. Set the movement amount as the increment mode and the unit as pulse.

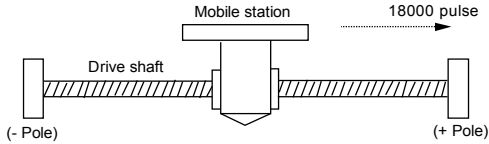

■ Settings

Item	Setting Example		
	Table 1	Table 2	Table 3
Operation pattern	P: Passing Point	P: Passing Point	E: end point
Control method	I: increment	I: increment	I: increment
X-axis movement amount	5,000 pulse	10,000 pulse	3,000 pulse
Acceleration/deceleration method	L: linear	L: linear	L: linear
Acceleration time (ms)	100 ms	200 ms	30 ms
Deceleration time (ms)	10 ms	20 ms	150 ms
Target speed	10,000 pps	20,000 pps	5,000 pps

■ Operation diagram

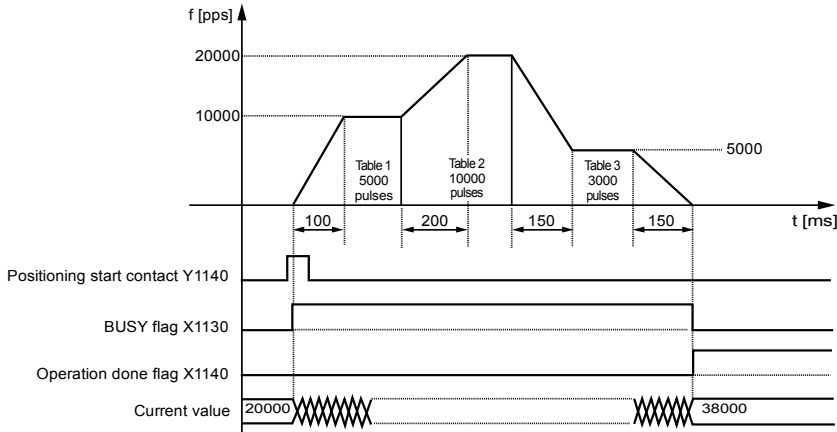

■ Operation of each contact

- The BUSY flag (X1130), which indicates that the motor is running, will turn ON when the positioning control starts, and it will turn OFF when the operation completes.
- The operation done flag (X1140), which indicates the completion of operation, will turn ON when the current operation is completed, and it will be held until the next positioning control, JOG operation, home return, or pulsar operation starts. The flag will turn ON after the unit transmits a reference for the target position.

11.1.4 Setting and Operation of C-point Control

The following example is explained with the independent axis control of axis-1. Set the **movement amount as the increment mode and the unit as pulse**.

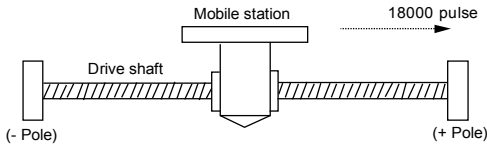

■ Settings

Position control data and parameters are set via the tool software. Unit set to pulse

Item	Setting Example		
	Table 1	Table 2	Table 3
Operation pattern	C: Continuance Point	C: Continuance Point	E: end point
Control method	I: increment	I: increment	I: increment
X-axis movement amount	5,000 pulse	10,000 pulse	3,000 pulse
Acceleration/deceleration method	L: linear	L: linear	L: linear
Acceleration time (ms)	100 ms	200 ms	30 ms
Deceleration time (ms)	10 ms	20 ms	150 ms
Target speed	10,000 pps	20,000 pps	5,000 pps

■ Operation diagram

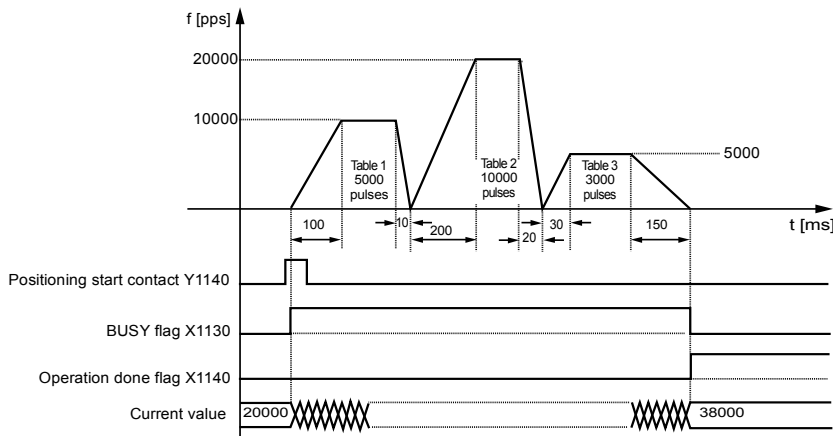

■ Operation of each contact

- The BUSY flag (X1130), which indicates that the motor is running, will turn ON when the positioning control starts, and it will turn OFF when the operation completes.
- The operation done flag (X1140), which indicates the completion of operation, will turn ON when the current operation is completed, and it will be held until the next positioning control JOG operation, home return, or pulsar operation starts. The flag will turn ON after the unit transmits a reference for the target position.

11.1.5 Setting and Operation of J-point Control

J-point control operates at the target speed from the operation start to the position control start contact of J-point control is ON, and start the next position control when the J-point control is ON.

■ Settings

Item	Setting Example			
	Data table 1	J-point axis parameter settings	Data table 2	Data table 3
Operation pattern	J: Speed Point	—	P: Passing Point	E: end point
Control method	I: increment	—	I: increment	I: increment
X-axis movement amount	5,000 pulse	—	10,000 pulse	3,000 pulse
Acceleration/deceleration method	L: linear	—	L: linear	L: linear
Acceleration time (ms)	100 ms	—	200 ms	30 ms
Deceleration time (ms)	10 ms	—	20 ms	150 ms
Target speed	10,000 pps	—	20,000 pps	5,000 pps
J-point - running setting code	—	Linear acceleration/deceleration	—	—
J-point - acceleration time (ms)	—	10 ms	—	—
J-point - deceleration time (ms)	—	10 ms	—	—
J point target speed	—	30,000 pps	—	—



◆ KEY POINTS

- Specify parameters in the position control data table at the beginning of operation. Specify parameters upon speed change in the axis parameters settings menu.
- The J-point control can only be used for the independent axis control. It can not be used for the interpolation control.
- Please adopt the increment mode for the P-point control, C-point control and E-point control after the J-point control.
- Execute the speed control with the J-point control, but the constant value must be input at the target speed for the movement amount of the position control.

■ Operation diagram

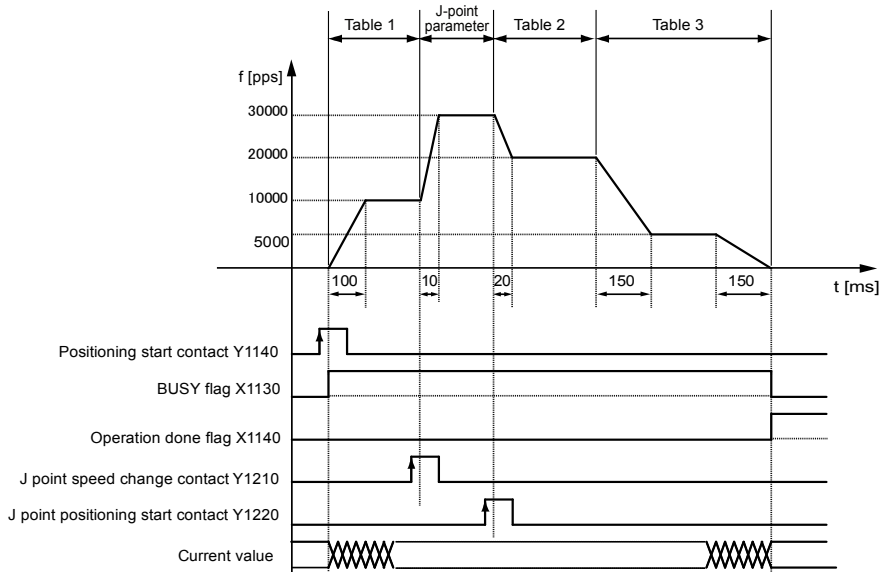

■ Operation of each contact

- The BUSY flag (X1130) is in ON at startup and then OFF at the end of operation.
- It indicates that the action completion flag (X1140) is in ON at the end of operation, and has been holden to any action from the next position control, JOG operation, home return and pulsar operation for startup.
- The target speed is changed when the contact (Y1210) of the J-point speed change is in ON. The speed change contact is valid in the pulse edge of OFF→ON.
- Start the position control action when starting points (Y1220) of the J-point position control are in ON.

■ Actions with the speed change contact in ON during acceleration and deceleration

- Change speed during action of the J-point control, rather than during acceleration (deceleration).
- When the speed change signal is in ON during acceleration (deceleration), first convert to the constant speed status and then execute the speed change action.

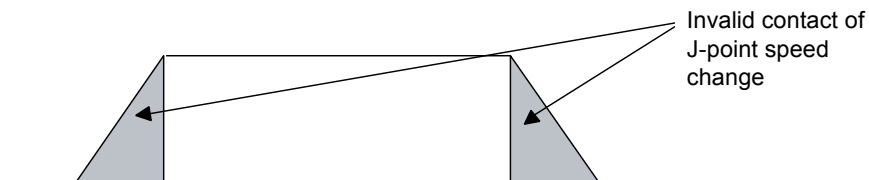

11.1.6 Sample Program (E-point, P-point and C-point Control)

■ Sample program

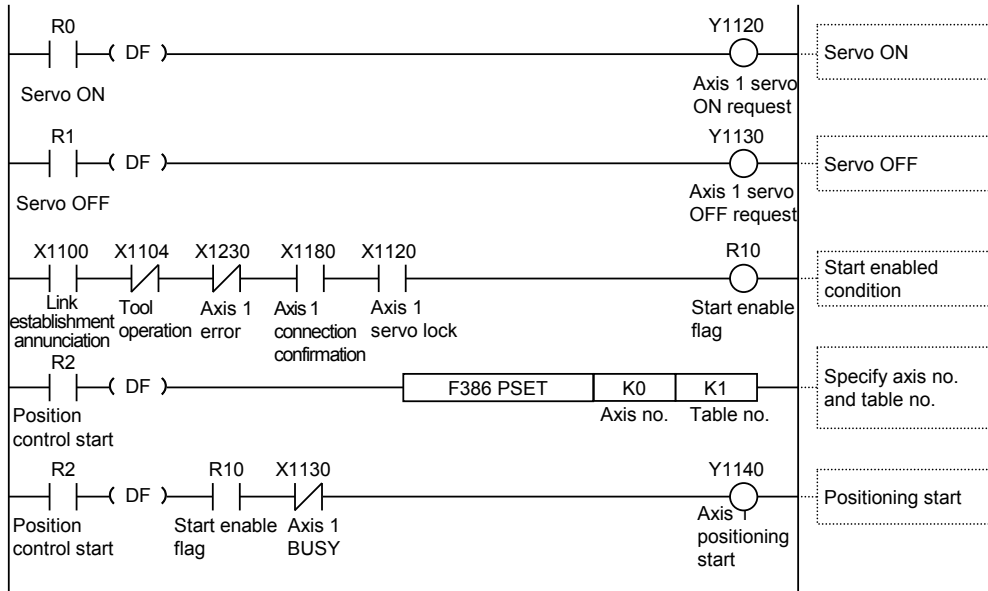

11.1.7 Sample Program (J-point Control)

■ Sample program

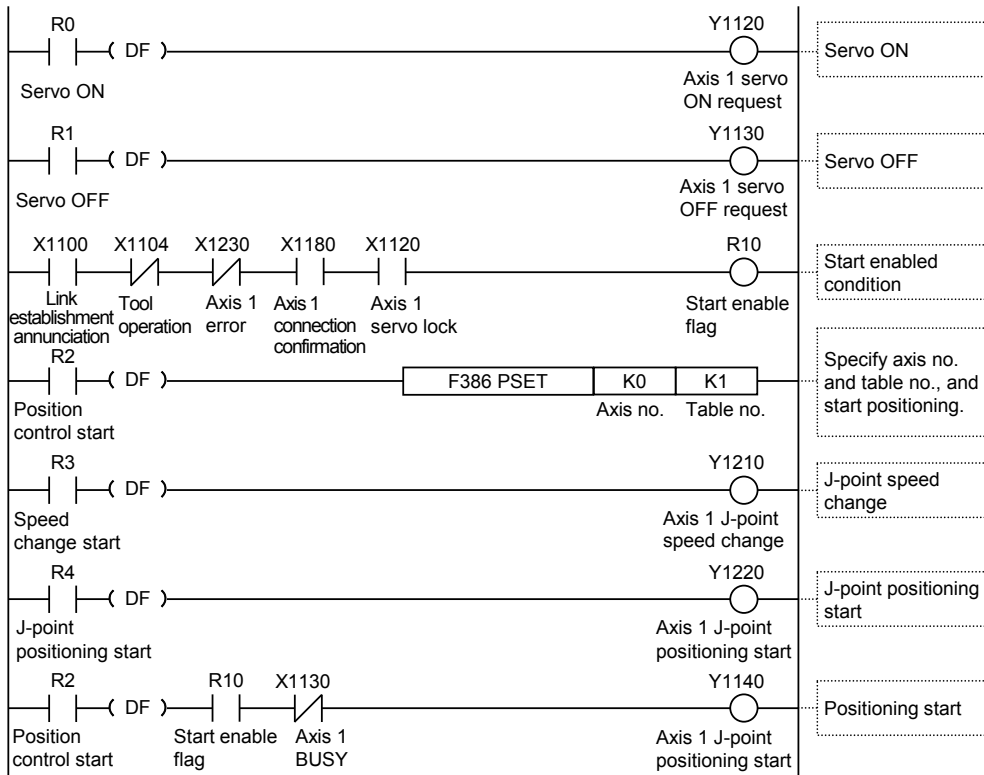

11.1.8 Programming Precautions

■ Programming Precautions

The last table should be set to E: End point.

- If any value such as a movement amount, acceleration time, deceleration time or target speed is out of the specified range, a set value error will occur when the positioning control starts.
- The start contact and flag number varies depending on the number of axes

■ Operation at limit input

Conditions	Direction	Limit Status	Operation
At each control start	Forward rotation	Limit input (+): ON	Not executable, Error occurs.
		Limit input (-): ON	Not executable, Error occurs.
	Reverse rotation	Limit input (+): ON	Not executable, Error occurs.
		Limit input (-): ON	Not executable, Error occurs.
During each type of control	Forward rotation	Limit input (+): ON	Deceleration stop, Error occurs.
	Reverse rotation	Limit input (-): ON	Deceleration stop, Error occurs.

11.2 Interpolation Control

11.2.1 Interpolation Control Types

■ Operation types

- Interpolation control includes 2-axis linear interpolation control, 2-axis circular interpolation control, 3-axis linear interpolation control, and 3-axis spiral interpolation control. The following methods are available to specify the operation of each interpolation control. Select an appropriate method according to the application. The axes in the relation of interpolation are called X-axis and Y-axis for the 2-axis interpolation, and are called X-axis, Y-axis, and Z-axis for the 3-axis interpolation. X-, Y-, and Z-axes are automatically assigned in ascending order of axis signal levels.
- In each type of interpolation control, the E-point control that uses one table, P-point control and C-point control that uses multiple tables can be combined arbitrarily as positioning data.
- For example, using P-point control enables continuous interpolation control from 2-axis linear control to 2-axis circular interpolation control. The acceleration time and deceleration time can be specified individually. For P-point control and C-point control, an E point should be set as the last table.

Type	Action designation mode	Necessary data
2 axis linear interpolation control	Resultant speed assignment	Resultant speed of the X-axis and Y-axis.
	Long-axis Speed Assignment	Speed of the long-axis (axis with longer moving distance)
2 axis arc interpolation control	Center point assignment/CW direction	X-axis and Y-axis coordinates of center point
	Center point assignment/CCW direction	X-axis and Y-axis coordinates of center point
	Passing point assignment	X-axis and Y-axis coordinates of passing point on the arc
3 axis linear interpolation control	Resultant speed assignment	Resultant speed of the X-axis, Y-axis and Z-axis.
	Long-axis Speed Assignment	Speed of the long-axis (axis with longer moving distance)
3 axis spiral interpolation control	Center point assignment/CW direction/X-axis feeding	Y-axis and Z-axis coordinates of center point
	Center point assignment/CCW direction/X-axis feeding	Y-axis and Z-axis coordinates of center point
	Center point assignment/CW direction/Y-axis feeding	X-axis and Z-axis coordinates of center point
	Center point assignment/CCW direction/Y-axis feeding	X-axis and Z-axis coordinates of center point
	Center point assignment/CW direction/Z-axis feeding	X-axis and Y-axis coordinates of center point
	Center point assignment/CCW direction/Z-axis feeding	X-axis and Y-axis coordinates of center point
	Passing point assignment/X-axis feeding	Y-axis and Z-axis coordinates of passing point on the arc
	Passing point assignment/Y-axis feeding	X-axis and Z-axis coordinates of passing point on the arc
	Passing point assignment/Z-axis feeding	X-axis and Y-axis coordinates of passing point on the arc

2-axis linear interpolation
(Composite speed specification)

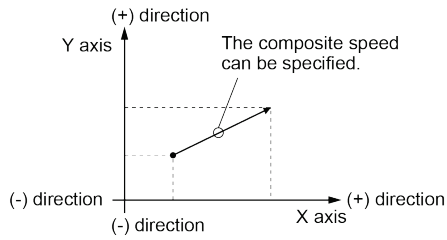

2-axis linear interpolation
(Long axis speed specification)

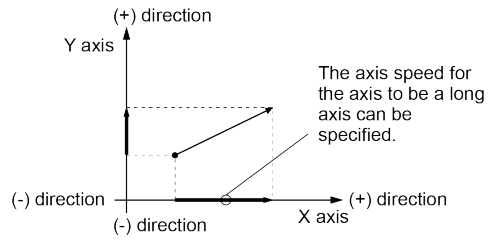

2-axis circular interpolation
(Center point specification/CW direction)

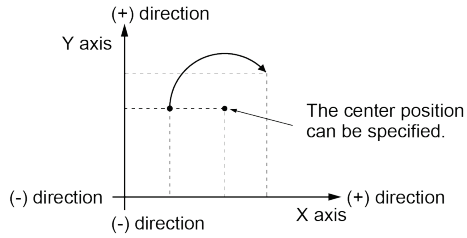

2-axis circular interpolation
(Center point specification/CCW direction)

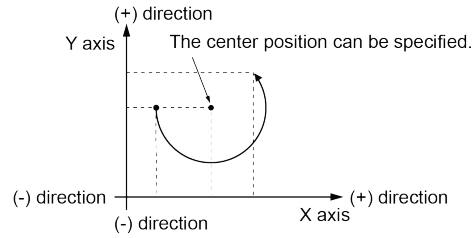

2-axis circular interpolation
(Pass point point specification)

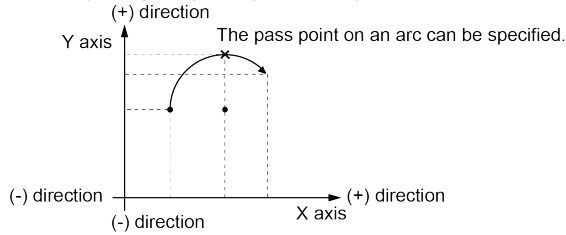

Automatic Operation (Position Control)

3-axis linear interpolation
(Composite speed specification)

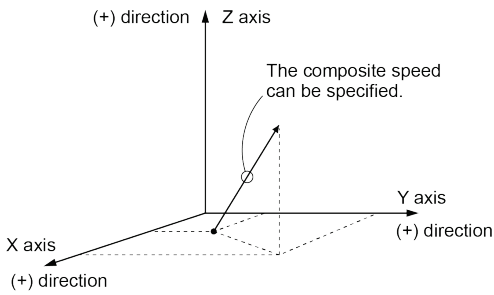

3-axis linear interpolation
(Long axis speed specification)

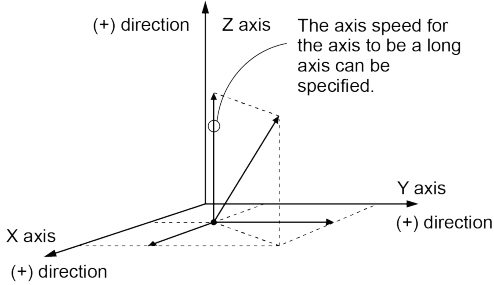

3-axis spiral interpolation (Center point specification/
CW direction/Z-axis movement)

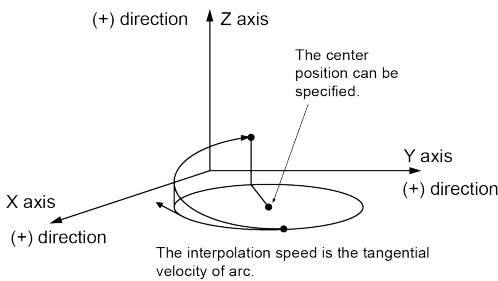

3-axis spiral interpolation (Center point specification/
CCW direction/Z-axis movement)

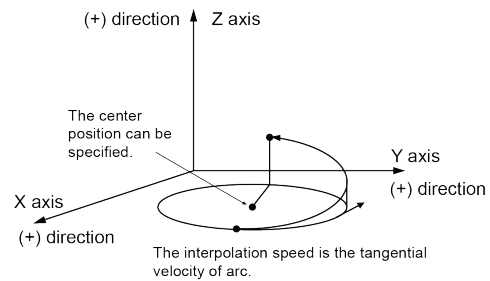

3-axis spiral interpolation (Pass point specification/
Z-axis movement)

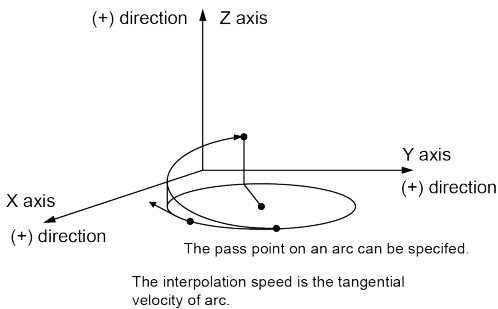

(Note): When the X-axis and Y-axis is the moving axes, each axis in the above diagram is replaced.

11.2.2 Setting and Operation of 2-axis Linear Interpolation

The following example is explained with the execution of the E-point control. Set the X-axis as axis-1, Y-axis as axis-2, movement amount as the increment mode and unit as pulse.

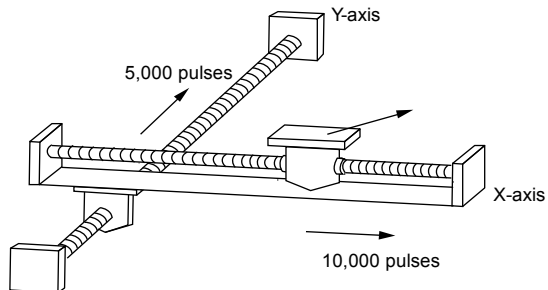

■ Settings

Item	Setting Example
Operation pattern	E: end point
Interpolation operation	0: Linear (resultant speed)
Control method	I: increment
X-axis movement amount	10,000 pulse
X-axis auxiliary point	0
Y-axis movement amount	5,000 pulse
Y-axis auxiliary point	0
Acceleration/deceleration method	L: linear
Acceleration time (ms)	100 ms
Deceleration time (ms)	100 ms
Interpolation speed	10,000 pps

■ Operation diagram

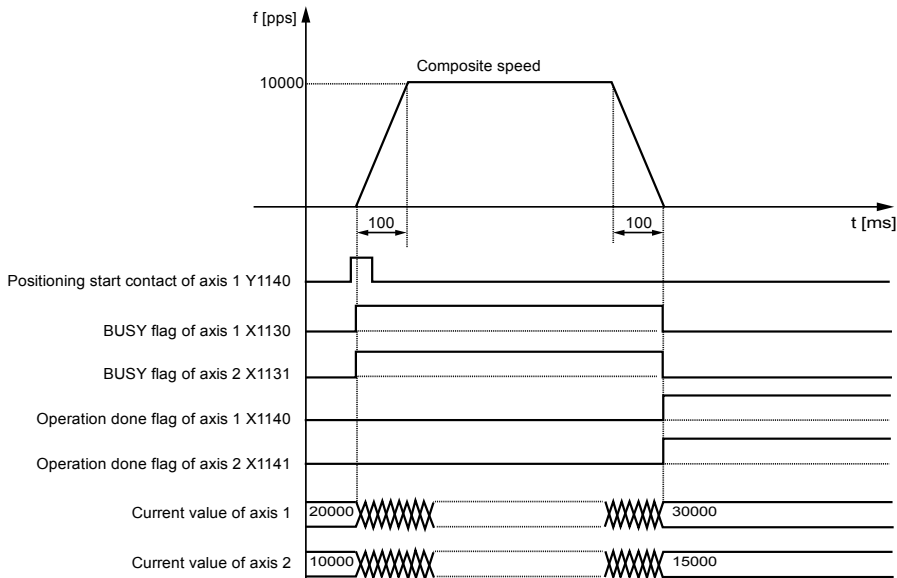

■ Operation of each contact

- The 1st axis and 2nd axis BUSY flags (X1130 and X1131) indicating the state that a motor is running will turn ON when the positioning control starts, and they will turn OFF when the operation completes.
- The 1st axis and 2nd axis operation done flags (X1140 and X1141) indicating the state that an operation completed will turn ON when the JOG operation is completed, and they will be held until the next positioning control, JOG operation, home return, or pulsar operation starts.

■ Programming precautions

- To start the interpolation control, turn ON the positioning start contact of the axis with the smallest number in the same group.
- The values of the X-axis auxiliary point and Y-axis auxiliary point are invalid for the linear interpolation.
- In the case of specifying long axis speed, the composite speed will be faster than the long axis speed.
- If any value such as a movement amount, acceleration time, deceleration time or target speed is out of the specified range, a set value error will occur when the positioning control starts.
- The starting point and flag number vary with the axis number.

11.2.3 Setting and Operation of 2-axis Circular Interpolation

The following example is explained with the execution of the E-point control. Set the X-axis as axis-1, Y-axis as axis-2, movement amount as the increment mode and unit as pulse.

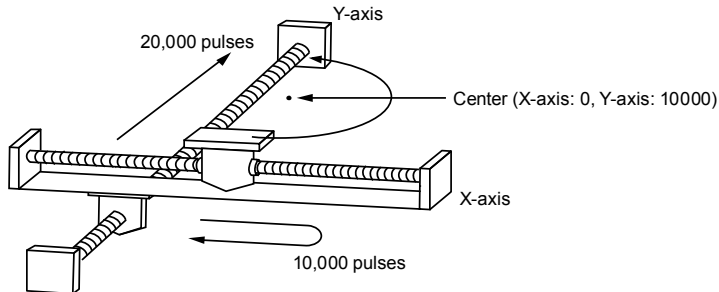

■ Settings

Position control data and parameters are set via the tool software. Unit set to pulse

Item	Setting Example
Operation pattern	E: end point
Interpolation operation	S: arc (center point/CW direction)
Control method	I: increment
X-axis movement amount	0 pulse
X-axis auxiliary point	0 pulse
Y-axis movement amount	20,000 pulse
Y-axis auxiliary point	10,000 pulse
Acceleration/deceleration method	L: linear
Acceleration time (ms)	100 ms
Deceleration time (ms)	100 ms
Interpolation speed	10,000 pps

■ Operation diagram

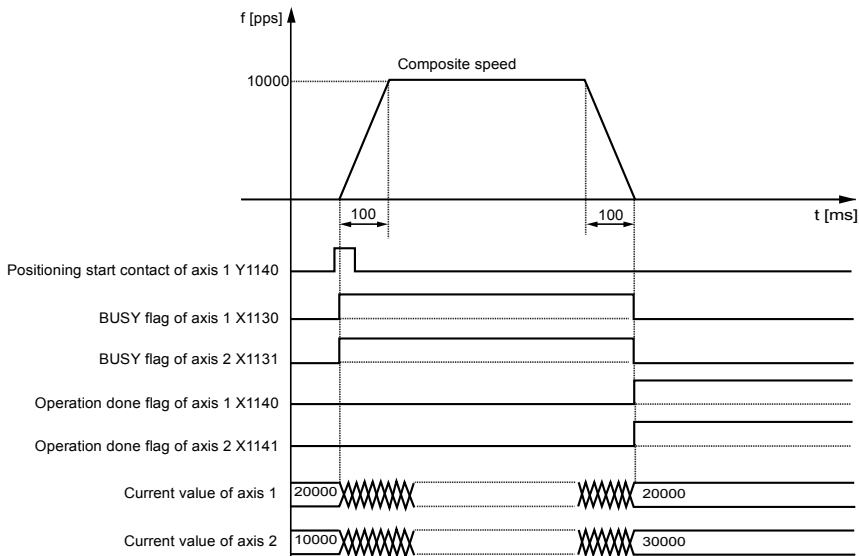

■ Operation of each contact

- The 1st axis and 2nd axis BUSY flags (X1130 and X1131) indicating the state that a motor is running will turn ON when the positioning control starts, and they will turn OFF when the operation completes.
- The 1st axis and 2nd axis operation done flags (X1140 and X1141) indicating the state that an operation completed will turn ON when the JOG operation is completed, and they will be held until the next positioning control, JOG operation, home return, or pulsar operation starts.

■ Programming precautions

- To start the interpolation control, turn ON the positioning start contact of the axis with the smallest number in the same group.
- In the case of the center point specification, the X-axis auxiliary point is the center point of X-axis, and the Y-axis auxiliary point is the center point of Y-axis. In the case of the pass point, each pass point is set as the pass point of X-axis and Y-axis.
- When the control method is increment, both the center point and pass point will be increment coordinates from the start point.
- When the start point and the operation done point is the same, it performs one circular operation when using the center point method. However, when using the pass point method, an error will occur.
- In the case of the pass point method, when the start point, pass point, and operation done point exist in the same straight line, an arc will not be comprised and an error will occur.
- In the case of specifying long axis speed, the composite speed will be faster than the long axis speed.
- If any value such as a movement amount, acceleration time, deceleration time or target speed is out of the specified range, a set value error will occur when the positioning control starts.
- The starting point and flag number vary with the axis number.

11.2.4 Setting and Operation of 3-axis Linear Interpolation

The following example is explained with the execution of the E-point control. Set the X-axis as axis-1, Y-axis as axis-2, Z-axis as axis-3, movement as the increment mode and unit as pulse.

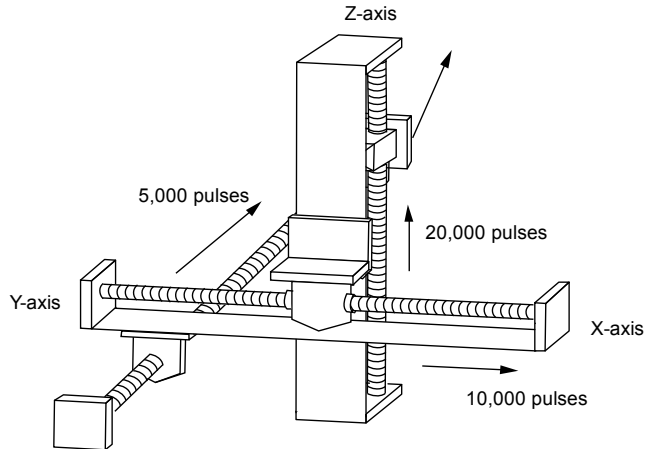

■ Settings

Item	Setting Example
Operation pattern	E: end point
Interpolation operation	0: Linear (resultant speed)
Control method	I: increment
X-axis movement amount	10,000 pulse
X-axis auxiliary point	0
Y-axis movement amount	5,000 pulse
Y-axis auxiliary point	0
Z-axis movement amount	20,000 pulse
Z-axis auxiliary point	0
Acceleration/deceleration method	L: linear
Acceleration time (ms)	100 ms
Deceleration time (ms)	100 ms
Interpolation speed	10,000 pps

■ Operation diagram

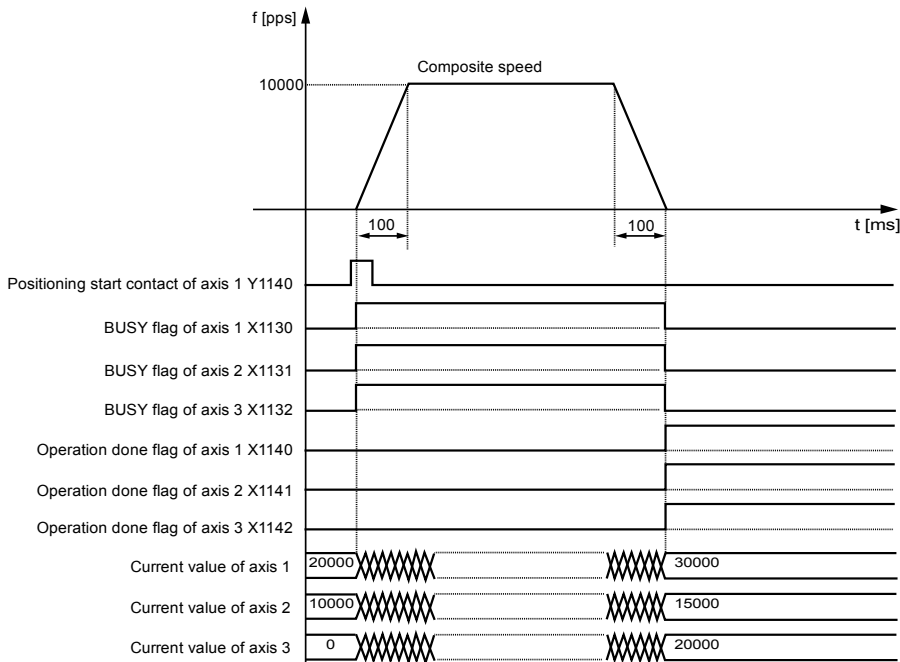

■ Operation of each contact

- The 1st axis, 2nd axis, and 3rd axis BUSY flags (X1130, X1131 and X1132) indicating the state that a motor is running will turn ON when the positioning control starts, and they will turn OFF when the operation completes.
- The 1st axis, 2nd axis, and 3rd axis operation done flags (X1140, X1141 and X1142) indicating the state that an operation completed will turn ON when the JOG operation is completed, and they will be held until the next positioning control, JOG operation, home return, or pulser operation starts.

■ Programming precautions

- To start the interpolation control, turn ON the positioning start contact of the axis with the smallest number in the same group.
- The values of the X-axis auxiliary point and Y-axis auxiliary point are invalid for the linear interpolation.
- In the case of specifying long axis speed, the composite speed will be faster than the long axis speed.
- If any value such as a movement amount, acceleration time, deceleration time or target speed is out of the specified range, a set value error will occur when the positioning control starts.
- The start contact and flag number varies depending on the number of axes and the installation position of the unit.
- The starting point and flag number vary with the axis number.

11.2.5 Setting and Operation of 3-axis Spiral Interpolation

The following example is explained with the execution of the E-point control. Set the X-axis as axis-1, Y-axis as axis-2, Z-axis as axis-3, movement as the increment mode and unit as pulse.

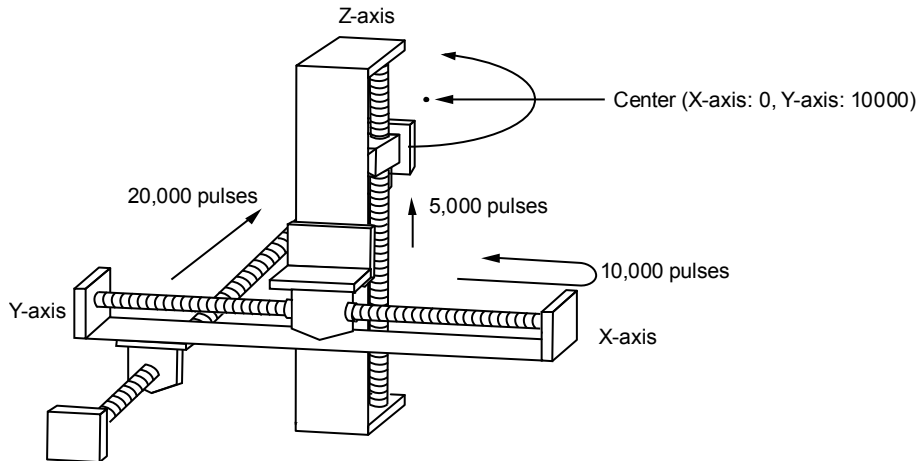

■ Settings

Item	Setting Example
Operation pattern	E: end point
Interpolation operation	E: spiral (center point/CCW direction/Z-axis feeding)
Control method	I: increment
X-axis movement amount	0 pulse
X-axis auxiliary point	0 pulse
Y-axis movement amount	20,000 pulse
Y-axis auxiliary point	10,000 pulse
Z-axis movement amount	5,000 pulse
Z-axis auxiliary point	0
Acceleration/deceleration method	L: linear
Acceleration time (ms)	100 ms
Deceleration time (ms)	100 ms
Interpolation speed	10,000 pps

■ Operation diagram

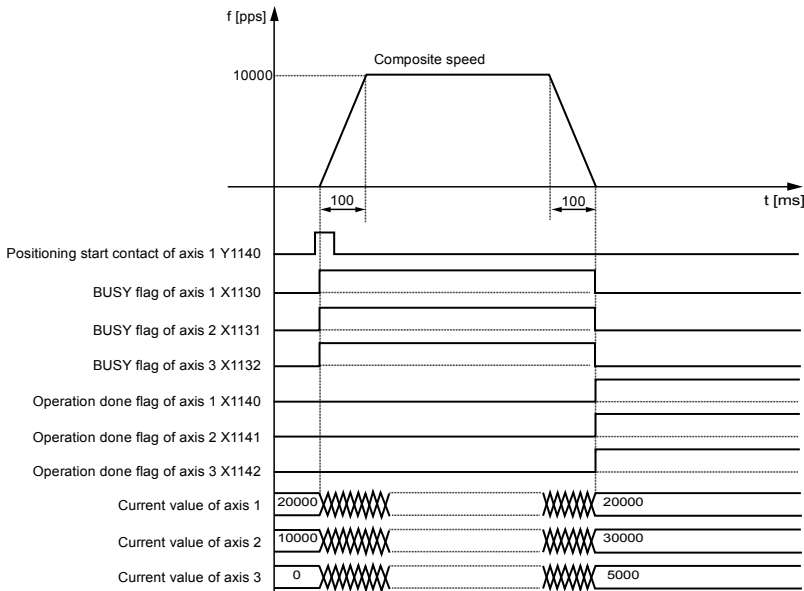

■ Operation of each contact

- The 1st axis, 2nd axis, and 3rd axis BUSY flags (X1130, X1131, and X1132) indicating the state that a motor is running will turn ON when the positioning control starts, and they will turn OFF when the operation completes.
- The 1st axis, 2nd axis, and 3rd axis operation done flags (X1140, X1141, and X1142) indicating the state that an operation completed will turn ON when the JOG operation is completed, and they will be held until the next positioning control, JOG operation, home return, or pulser operation starts.

■ Programming precautions

- For X-Y plane, in the case of the center point specification, the X-axis auxiliary point is the center point of X-axis, and the Y-axis auxiliary point is the center point of Y-axis. In the case of the pass point, each pass point is set as the pass point of X-axis and Y-axis. These settings are the same for Y-Z plane and X-Z plane.
- When the control method is increment, both the center point and pass point will be increment coordinates from the start point.
- When the start point and the operation done point is the same, it performs one circular operation when using the center point method. However, when using the pass point method, an error will occur.
- In the case of the pass point method, when the start point, pass point, and operation done point exist in the same straight line, an arc will not be comprised and an error will occur.
- In the case of specifying long axis speed, the composite speed will be faster than the long axis speed.
- If any value such as a movement amount, acceleration time, deceleration time or target speed is out of the specified range, a set value error will occur when the positioning control starts.
- The starting point and flag number vary with the axis number.

11.2.6 Sample Program (Interpolation Control)

3-axis interpolation control as the example.

■ Sample program

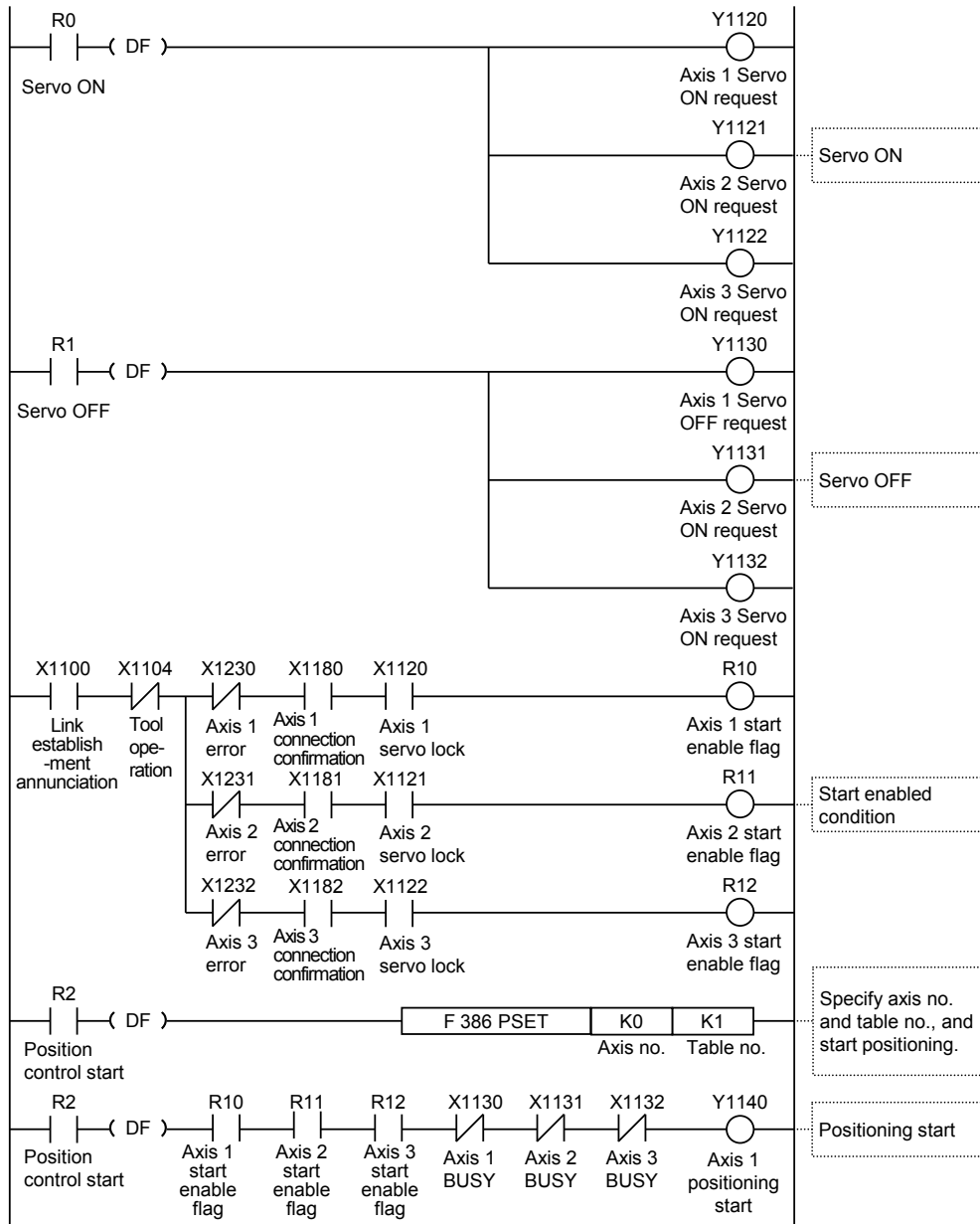

11.3 Positioning Repeat Function

Positioning repeat function means to specify the times of repetition for continuous position control at specified times.

The times of repetition is set in the position control repetitions area of each axis. The repetitions can be specified within 2~254, or be set to 255 to indicate infinite repetitions.

■ Overview of Positioning repeat function

The following figure shows repetition of the position control for 3 times.

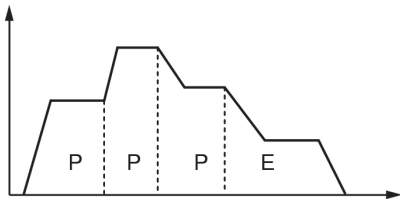

When the dwell is set to 0 with the E-point control of the end position control, the control unit processes E-point control as P-point control and repeats the position control for 3 times without stopping the operation before ending the operation.

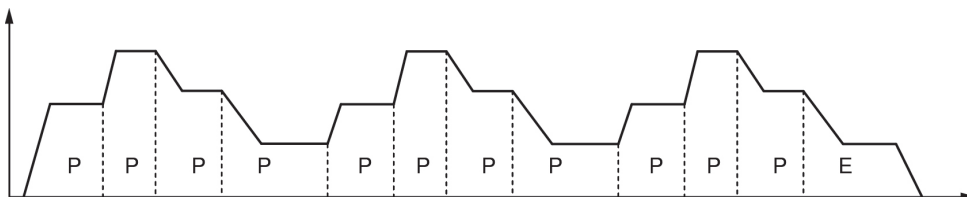

When the pause is set to a value other than 0 with the E-point control of the end position control, the control unit processes E-point control as C-point control and pause according to the set dwell time of pause before executing position control again.

The operation is ended after repetitions of position control for 3 times.

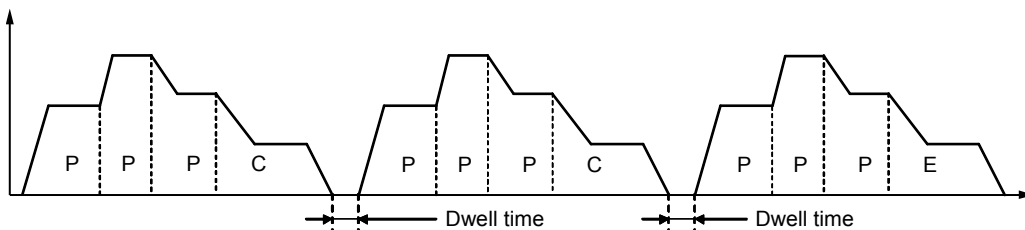

■ **Position control repetitions settings area (memory area no.0: common area)**

In this area, it is allowed to set the times of repetitions from the position control start by axis. The control unit will start repeating the position control that is started for the set times before ending the operation. The times of repetition will change to the initial value at the end of the operation.

Positioning memory offset address	Name	Description	Initial value	Setting Range	Unit
H108	Positioning repeat count of axis 1	Saves the times of repetition from the no. of the position control start data table to the E-point. If set to 255, the operation will be repeated infinitely before the operation is stopped.	0	0-255	Times
H109	Positioning repeat count of axis 2				
H10A	Positioning repeat count of axis 3				
H10B	Positioning repeat count of axis 4				
H10C	Positioning repeat count of axis 5				
H10D	Positioning repeat count of axis 6				
H10E	Positioning repeat count of axis 7 (or virtual)				
H10F	Positioning repeat count of axis 8 (or virtual)				

■ **Stop processing in the repetitive operation of position control**

During repetitions of position control, if deceleration stop is executed, the following operations will occur.

● **When E-point control is repeated (Dwell time : 0 ms)**

When the control unit detects the deceleration stop, it will stop after performing the repetitive position control N+2 times.

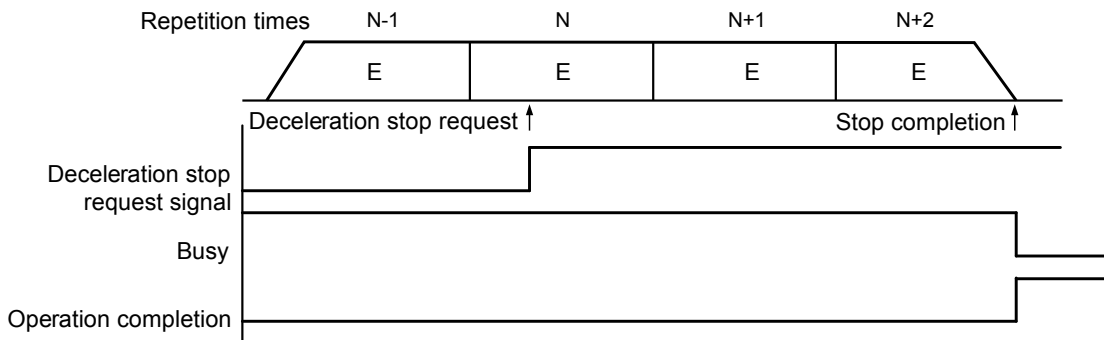

● **When continuously executing multiple position control data tables**

When the control unit detects the deceleration stop, it will stop after performing the repetitive position control N+1 times.

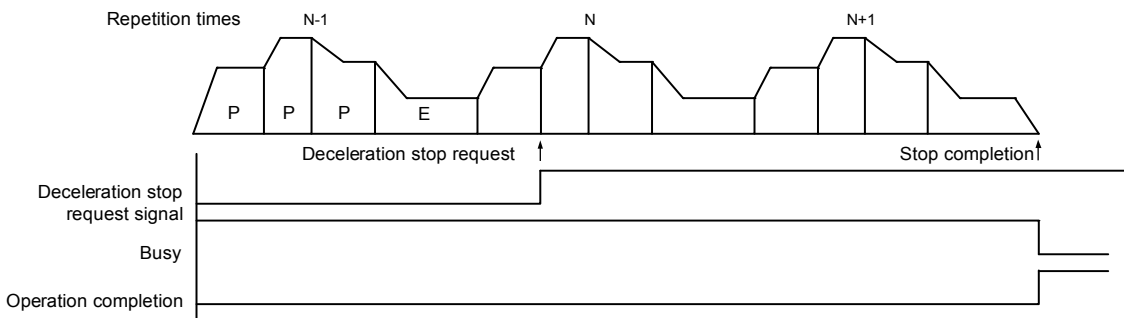

11.3.1 Setting and Operation of Repeat Operation

The following example is explained with the independent axis control. Set the movement amount as the increment mode and the unit as pulse.

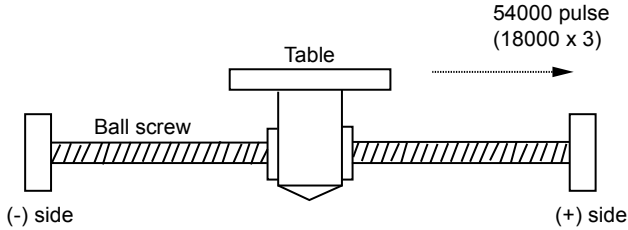

■ Settings

Item	Setting Example		
	Table 1	Table 2	Table 3
Operation pattern	P: Passing Point	P: Passing Point	E: end point
Control method	I: increment	I: increment	I: increment
X-axis movement amount	5,000 pulse	10,000 pulse	3,000 pulse
Acceleration/deceleration method	L: linear	L: linear	L: linear
Acceleration time (ms)	100 ms	200 ms	30 ms
Deceleration time (ms)	10 ms	20 ms	150 ms
Target speed	10,000 pps	20,000 pps	5,000 pps
Dwell time	0 ms	0 ms	0 ms
Repetitions of position control	3 (setting area for writing to the positioning memory)		

■ Operation diagram

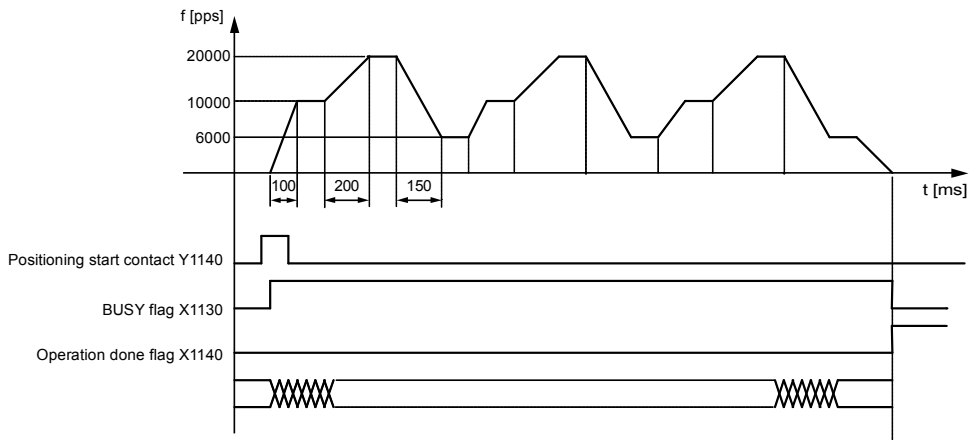

■ Operation of each contact

- The BUSY flag (X1130), which indicates that the motor is running, will turn ON when the positioning control starts, and it will turn OFF when the operation completes.
- The operation done flag (X1140), which indicates the completion of operation, will turn ON when the current operation is completed, and it will be held until the next positioning control, JOG operation, home return, or pulser operation starts.

■ Sample program

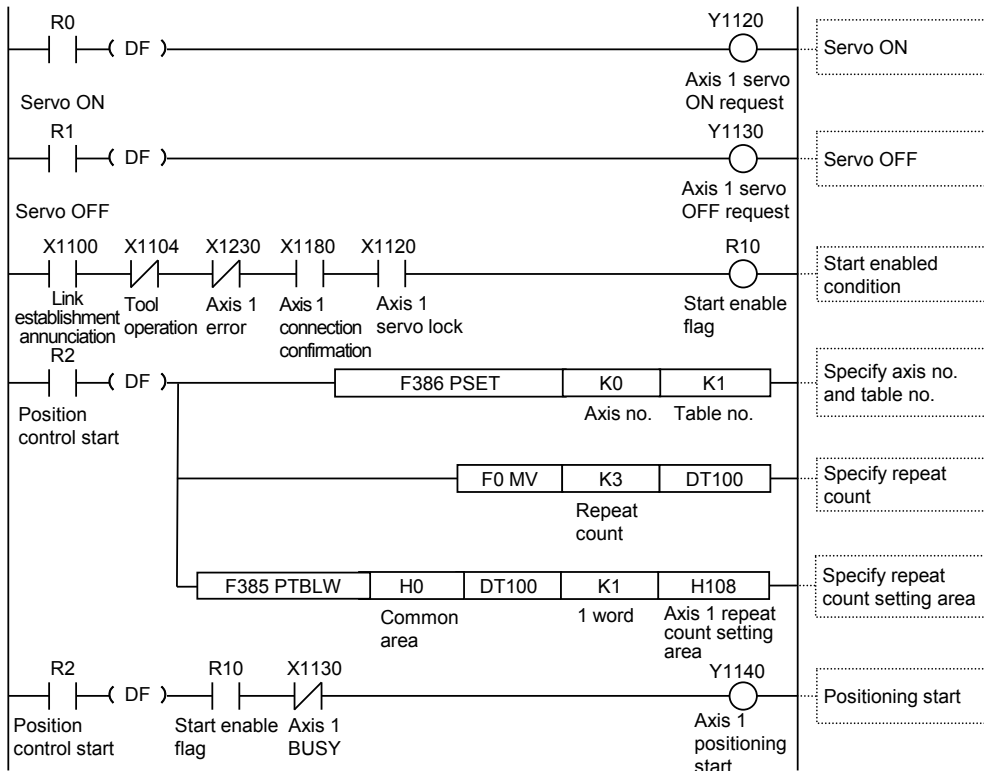

12

Automatic Operation (Synchronous Control)

12.1 Synchronous Control

12.1.1 Outline of Synchronous Control

The positioning unit in synchronous control operates a master axis so that slave axes will operate in synchronization with the master axis. The use of synchronous control provides the following merits.

1. Ease of setting

A number of related axes can be operated with ease by designing the operation of the axes based on the master axis.

2. Ensuring operational safety

If an axis comes to a stop for some reason while the positioning unit is in synchronous control, all the relevant axes under synchronous control will come to a stop. Therefore, you can easily increase the safety of the positioning unit.

■ Outline of synchronous control

The synchronous control provides the following functions. These functions are executed in order, and the slave axes operate according to the operation result of each function.

Function	Outline
Electronic gear	The number of pulses multiplied by the preset electronic gear ratio is output according to the operation of the master axis.
Electronic clutch	The operation of the slave axes can be separated from the operation of the master axis by disengaging the clutch.
Electronic cam	A function to output pulses according to the preset cam pattern. Calculates the operation phase of the master axis and outputs cam pulses according to the phase. The cam pattern is set with a setting tool.

■ Execution Order of Synchronous Control and Setting Procedure

The following section provides information on the outline of functions achieved by synchronous control and setting procedures for the functions.

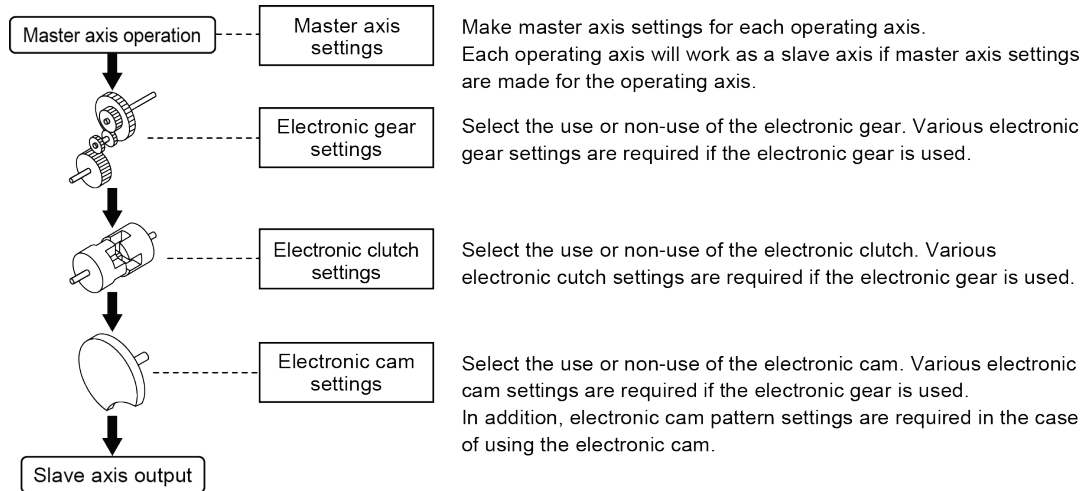

12.2 Settings for Master and Slave Axes

12.2.1 Selection for Master and Slave Axes

The master axis serves as a reference for synchronization control. Start and stop requests for various operations are made to the master axis under synchronous control. It is possible to select one of the following master axes.

■ Types of master axes

Types of master axes	Outline
Existing axis	Axis that can be physically controlled by the control unit (1~8 axis). It is used when you hope that the master axis is also used as a control object. When an actual axis is used as the master axis, it is allowed to use axes other than the master axis (7 axes) as the slave axes.
Virtual axis	A virtual axis exists in the control unit. The virtual axis does not perform the motor control
Pulse input	The action to make the pulse input value of the input unit as the master axis. It is used when connecting external devices on the bases of synchronous control such as external encoder. When pulse input is used as the master axis, the slave axis operates according to the pulse input. Therefore, special attention must be paid when starting or stopping operations via the control unit.

■ Types and restrictions of master axis

		Type		
		Existing axis	Virtual axis	Pulse input
Home return		Yes	Available to data setting only.	No
JOG operation		Yes	Yes	No
Positioning	Single axis	Yes	Yes	No
	Interpolation	Yes	No Available to single axis only.	No
Stop functions	System/Emergency/Deceleration stop	Yes	Yes	No
	Limit stop	Yes	Questionable Stops only with software limit because of no limit signal input.	No
	Error stop	Yes	Yes	No
Others			Necessary to make settings to use the virtual axis on the Configuration screen.	Synchronizes with external pulse input, and no master axis control is possible. To stop synchronous control, stop the slave axes.



◆ KEY POINTS

- While the positioning unit is in synchronous control, slave axes set to use the master axis will operate only in synchronization with the master axis, i.e., the slave axes cannot operate independently.
- The virtual axis is assigned to a single axis only. In the case of using the virtual axis, check the box for the virtual axis in the dialog box to set the operating axes on the Configurator PM7.
- The home return of the virtual axis is possible only by data setting.
- If pulse input is set for the master axis, the master axis will synchronize with pulse input from an external device, such as an encoder. Therefore, the master axis cannot be stopped arbitrarily.

12.2.2 Selection of Slave Axes and Settings

■ Selection of Slave Axes

The 1st to 8th axes are available as slave axes. The virtual axis can be used only as the master axis.

When “Synchronous master axis” is selected in the synchronous parameter dialog box of the Configurator PM7, the corresponding axis will operate as a slave axis for the specified master axis.

Up to eight slave axes can be set for a single master axis.

Axes set as slave axes operate in synchronization with the master axis as long as synchronous control is enabled. No slave axes can perform positioning and other control independently from the master axis while synchronous control is enabled.

■ Settings for Slave Axes

The slave axes operate in synchronization with the master axis. Set the following items, however, for each individual slave axis.

- Unit setting
- Number of pulses per rotation
- Movement amount per rotation

12.3 Start and Cancel of Synchronous Control

12.3.1 Start and Cancel of Synchronous Control

■ Start and cancel operations

- It is possible to cancel the synchronous control temporarily with a sync cancel request signal turned ON.
- It is possible to operate any slave axes individually while the synchronous state is canceled.
- The synchronous control can be started again with the sync cancel request signal turned OFF.
- The synchronous control can be cancelled while a master axis is activated.

■ I/O signal assignment

Signal name	Axis 1	Axis 2	Axis 3	Axis 4	Axis 5	Axis 6	Axis 7 (virtual)	Axis 8 (virtual)	Operation
Synchronous cancel request	Y1280	Y1281	Y1282	Y1283	Y1284	Y1285	Y1286	Y1287	On: Cancel synchronous control Off: Execute synchronous control
Synchronous cancel active announcement	X1280	X1281	X1282	X1283	X1284	X1285	X1286	X1287	On: Synchronous control being canceled Off: Under synchronous control

■ Operations while synchronous control is performed/canceled

Operation request axis		Operation while synchronous control is performed		Operation while synchronous control is canceled
		Master axis set	Slave axis set	Master/Slave axis set
Home return		<p>No</p> <p>The master axis performs a home return.</p> <p>The slave axes do not perform a home return but operate in synchronization with output from the master axis.</p> <p>For performing home return, cancel the synchronous control and operate.</p>	<p>No</p> <p>The slave axes do not operate in response to operation requests.</p>	<p>Yes</p> <p>The master axis or slave axes will perform a home return only if the master axis or the slave axes are so requested.</p>
JOG operation		<p>Yes</p> <p>The slave axes operate in synchronization with the operation request of the master axis.</p>		<p>Yes</p> <p>The master axis or slave axes will go into JOG operation only if the master axis or the slave axes are so requested.</p>
Positioning	Single axis	<p>Yes</p> <p>Interpolation will be executed upon request if the master axis is the start axis of interpolation.</p> <p>The slave axes operate in synchronization with the master axis.</p>		<p>Yes</p> <p>Interpolation will be executed upon request if the requested axis is the start axis of interpolation.</p>
	Interpolation			
Stop functions	System stop	All the axes come to a stop regardless of the synchronization settings.		
	Emergency stop	<p>Yes</p> <p>The master axis comes to a stop upon request.</p> <p>The slave axes come to a stop in synchronization with the master axis.</p>	<p>Yes</p> <p>Only axes requested come to a stop.</p> <p>The master axis and other slave axes set on the same master axis continue operating.</p>	<p>Yes</p> <p>Only axes requested come to a stop.</p> <p>(All the axes in interpolation operation come to a stop.)</p>
	Deceleration stop			
	Limit stop	The master axis and all the slave axes come to a stop.		Only axes resulting in a limit error come to a stop.
	Error stop			Only axes resulting in an error come to a stop.

(Note 1): When an error occurs in the master axis and slave axes, all axes will stop at the stop time of the master axis.

(Note 2): When a limit stop or error stop occurs in slave axes, the master axis will stop. Consequently all slave axes will stop at the stop time of the master axis.

12.3.2 Precautions When Canceling or Starting Synchronous Control

■ Precautions when canceling synchronous control

- The synchronous control can be canceled during the master operation, however, slave axes will stop immediately.
- It is recommended to cancel the synchronous control after stopping slave axes using the clutch function.
- When the synchronous control is canceled, relays related to the synchronous control (synchronous slave gear ratio change state annunciation, synchronous slave clutch connection state notification) will turn off.

■ Conditions for starting synchronous control

Only when the following conditions are met, the synchronous control can be started.

- Slave axes stop.
- No stop request for slave axes is generated.
- No error occurs in slave axes.

When these conditions are not met, the unit does not become the synchronous state and the synchronous control cancel active annunciation relay does not turn off. If the synchronous cancel request kept off while the conditions are not met, the synchronous control will start once the condition to start the synchronous control is met.

■ Phase when starting synchronous control

It is calculated from the "current value after unit conversion" of master axis and the "cam control synchronous master axis cycle" of synchronous parameter. The remainder obtained by dividing "current value after unit conversion" by "cam control synchronous master axis cycle" is used as a phase.

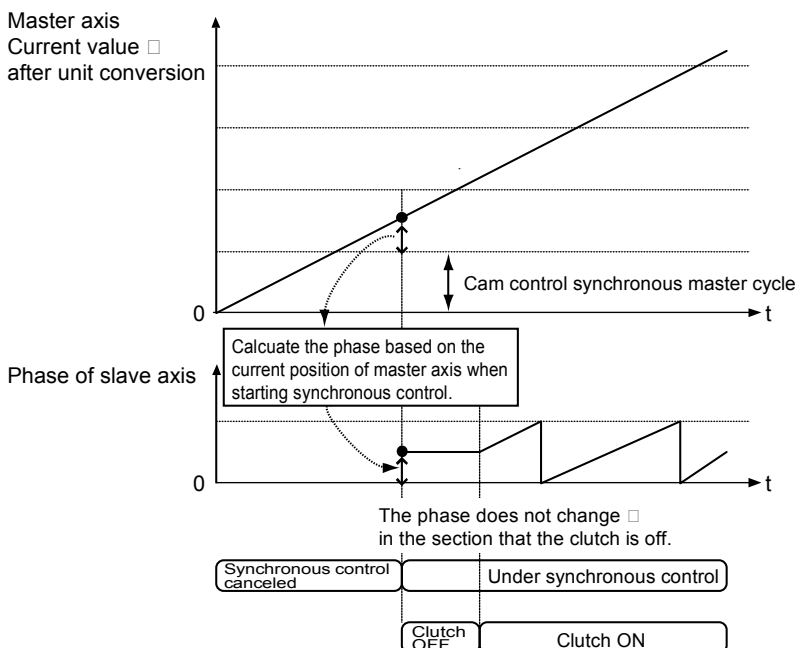

■ Procedures of canceling and starting synchronous control

The following shows the procedures when "Level" is selected for the clutch trigger type as an example.

Section	Procedure	Operation by user programs and unit operation
Synchronous canceled	Q ₁	Turn off the synchronous slave clutch ON request by a user program.
	Q ₂	The unit turns off the synchronous slave clutch connection state annunciation.
	Q ₃	Turn on the synchronous state cancel request by a user program.
	Q ₄	The unit cancel the synchronous control when the synchronous cancel active annunciation turns on.
Synchronous started	Q ₅	Turn off the synchronous state cancel request by a user program.
	Q ₆	The unit turns off the synchronous cancel active annunciation.
	Q ₇	Turn on the synchronous slave clutch ON request by a user program.
	Q ₈	The unit starts the synchronous operation of slave axes when the synchronous slave clutch connection state annunciation turns on.

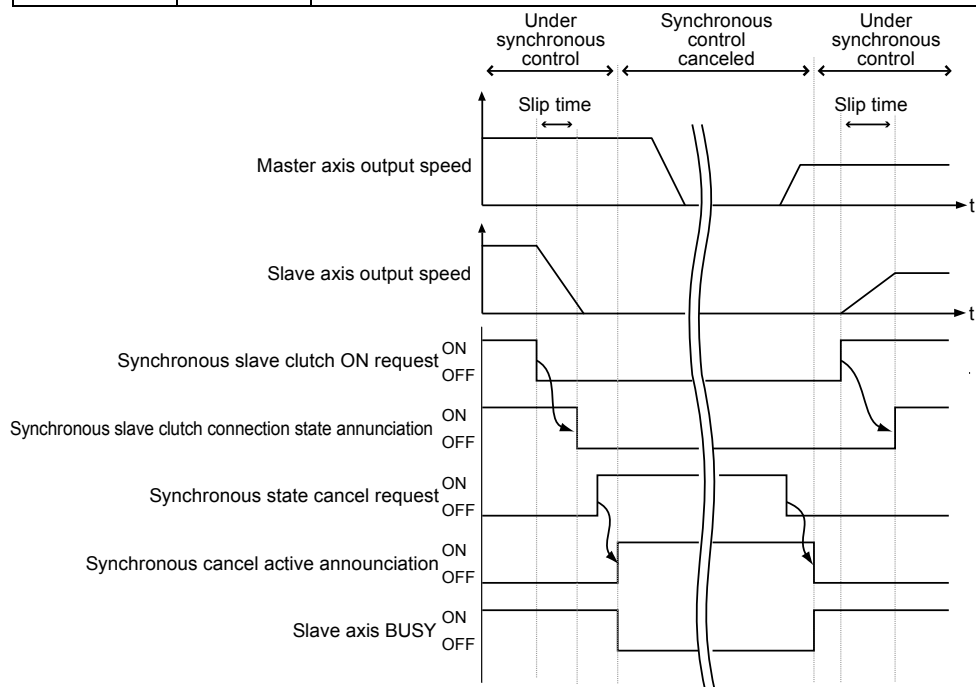

Signal name	Axis 1	Axis 2	Axis 3	Axis 4	Axis 5	Axis 6	Axis 7 (virtual)	Axis 8 (virtual)
Synchronous cancel request	Y1280	Y1281	Y1282	Y1283	Y1284	Y1285	Y1286	Y1287
Synchronous cancel active annunciation	X1280	X1281	X1282	X1283	X1284	X1285	X1286	X1287
Slave axis clutch ON request	Y1330	Y1331	Y1332	Y1333	Y1334	Y1335	Y1336	Y1337
Slave axis clutch operation annunciation	X1330	X1331	X1332	X1333	X1334	X1335	X1336	X1337
Slave axis BUSY	X1130	X1131	X1132	X1133	X1134	X1135	X1136	X1137

■ Operation when selecting "Level" for the clutch ON trigger type

- If the "synchronous slave clutch ON request" is on when the synchronous control start processing is executed, the clutch is connected by the direct method regardless of the setting of "slip method".
- However, if the "synchronous slave clutch ON request" is off when the synchronous control start processing is executed, the clutch is connected according to the setting of "slip method".

When the synchronous slave clutch ON request is on when the synchronous control start processing is executed

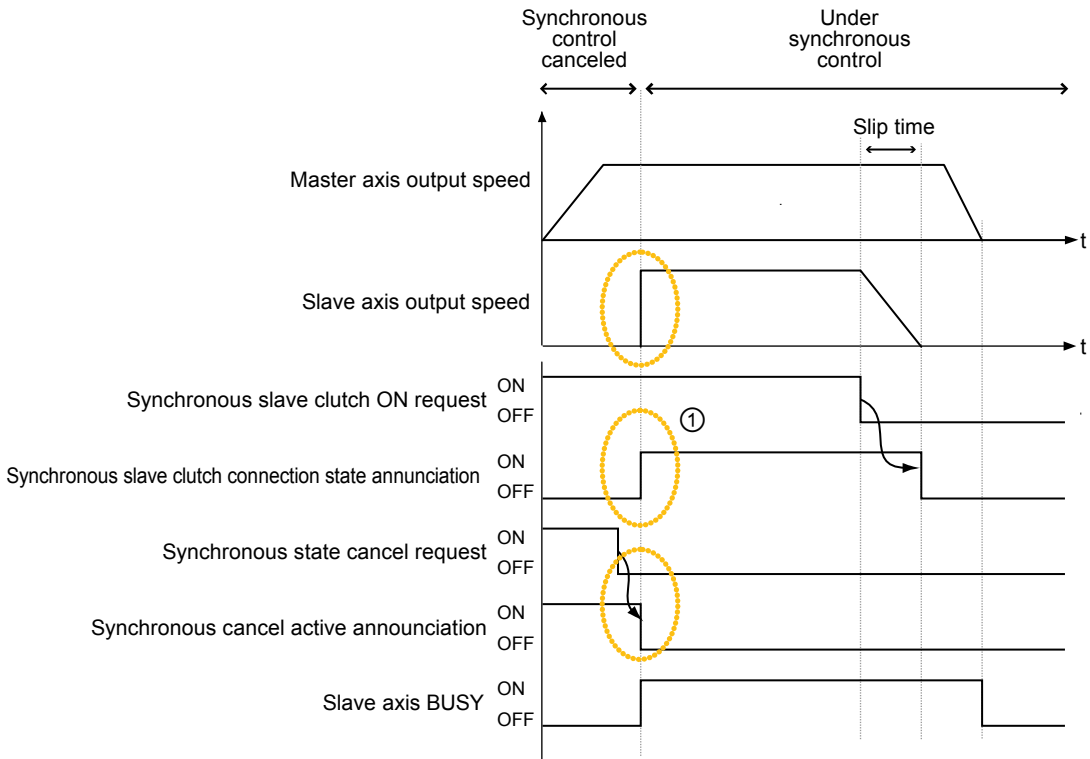

Q	The slave axes start the operation immediately as the clutch is connected (synchronous slave clutch connection state annunciation: ON) when the synchronous control starts (synchronous cancel active annunciation: OFF).
---	---

When the synchronous slave clutch ON request is off when the synchronous control start processing is executed

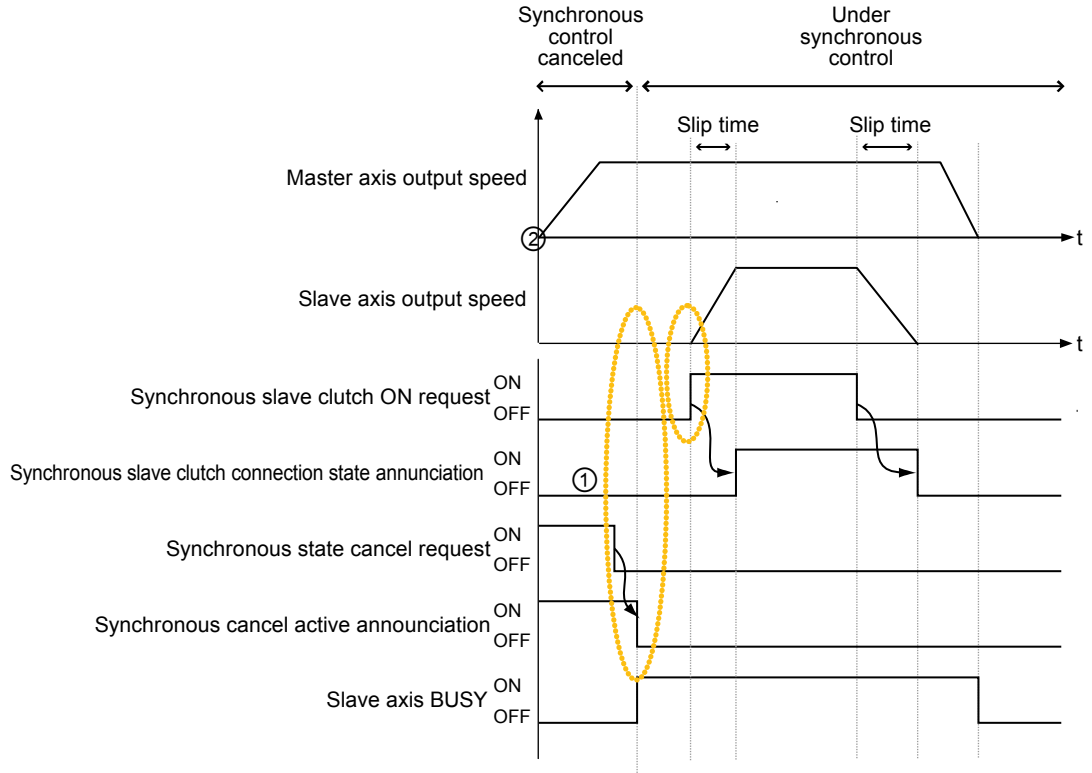

Q1	The slave axes do not operate immediately as the clutch is not connected (synchronous slave clutch connection state annunciation: OFF) when the synchronous control starts (synchronous cancel active annunciation: OFF).
Q2	Slave axes start the operation by the synchronous slave clutch ON request.

I/O Allocation

Signal name	Axis 1	Axis 2	Axis 3	Axis 4	Axis 5	Axis 6	Axis 7 (virtual)	Axis 8 (virtual)
Synchronous cancel request	Y1280	Y1281	Y1282	Y1283	Y1284	Y1285	Y1286	Y1287
Synchronous cancel active annunciation	X1280	X1281	X1282	X1283	X1284	X1285	X1286	X1287
Slave axis clutch ON request	Y1330	Y1331	Y1332	Y1333	Y1334	Y1335	Y1336	Y1337
Slave axis clutch operation annunciation	X1330	X1331	X1332	X1333	X1334	X1335	X1336	X1337
Slave axis BUSY	X1130	X1131	X1132	X1133	X1134	X1135	X1136	X1137

12.4 Electronic Gear Function

12.4.1 Outline of Electronic Gear Function

■ Electronic Gear Function

The electronic gear function operates the positioning unit at the speed of the master axis multiplied by a preset gear ratio.

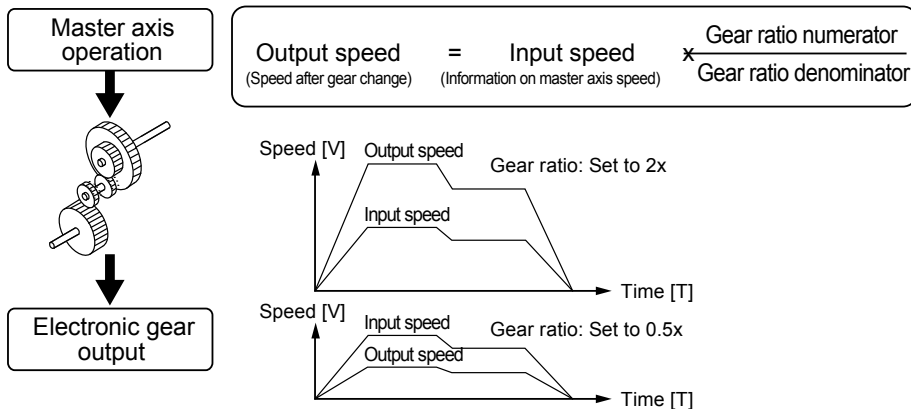

■ Cautions for using the electronic gear function.

The use of the electronic gear function makes it possible to set the slave axes to a desired speed relative to the master axis. The movement amount of the slave axes, however, is obtained from the following formula. Therefore, the movement amount of the master axis does not coincide with that of the slave axes.

Movement amount of slave axes = Movement amount of master axis x (gear ratio numerator/Gear ratio denominator)

* On the condition that the gear ratios are constant.

Do not use the electronic gear function if the movement amount of the master axis needs to coincide with that of the slave axes.



◆ NOTE

Keep in mind that the slave axes may come to a sudden stop if an emergency stop or deceleration stop is executed while making a gear ratio change.

12.4.2 Types and Contents of Setting Parameters

The use of the electronic gear requires the following parameter settings.

Parameter name	Outline
Electronic gear operation settings	<p>Set to use or not to use the electronic gear function.</p> <p>The gear ratio of the electronic gear will be set to 1:1 if the electronic gear is not used, and the operation of the master axis will be input as it is into the electronic clutch.</p>
Gear ratio numerator	Determines the gear ratio of the electronic gear.
Gear ratio denominator	<p>Electronic gear ratio is determined by the following formula.</p> <p>Output speed of electronic gear = Operating speed of master axis x (Gear ratio numerator/Gear ratio denominator)</p>
Gear ratio change time	The time required to change the current gear ratio to a new gear ratio if the new gear ratio is set for the electronic gear in operation.

12.4.3 Gear Ratio Changes while in Operation

■ Precautions for gear ratio changes while the positioning unit is in operation

- If the gear ratio is changed with a new gear ratio while the electronic gear is in operation, the new gear ratio will be effective with an elapse of a preset gear change time.
- If the gear ratio change time is 1, the gear ratio will be changed at an acceleration/deceleration time of 0.
- Acceleration or deceleration during the gear ratio change results in linear acceleration or deceleration. S-shaped acceleration or deceleration cannot be used.

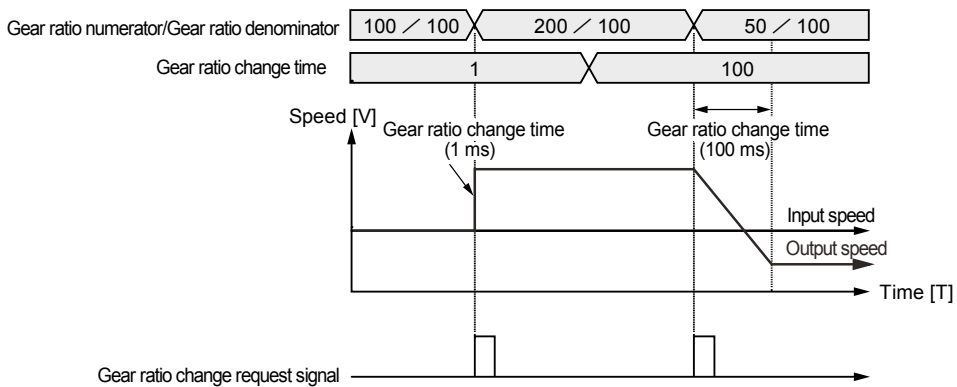

■ Programming

Follow the procedure below and write a user program in the case of changing the gear ratio while the positioning unit is in operation.

1. Change the gear ratio.

- Change the gear ratio numerator and denominator of the electronic gear in the setting area for the electronic gear.
- The gear ratio at the time of starting the positioning unit is set for this area. It is recommended to save the initial gear ratio before change so that the initial gear ratio can be reused with ease.

2. Set the gear ratio change request contact to ON

- Turn ON an I/O signal (electronic gear ratio change request) for the target axis allocated to the unit.
- This signal enabled is of edge type. Starts the gear ratio change triggered by the gear ratio change request signal turned ON.

■ I/O Allocation

Signal name	Axis 1	Axis 2	Axis 3	Axis 4	Axis 5	Axis 6	Axis 7 (virtual)	Axis 8 (virtual)
Slave axis gear ratio change request	Y1310	Y1311	Y1312	Y1313	Y1314	Y1315	Y1316	Y1317
Slave axis gear ratio change state annunciation	X1310	X1311	X1312	X1313	X1314	X1315	X1316	X1317

After the change, please set the gear ratio change request signal to OFF.



◆ **REFERENCE**

For details about the gear ration setting area, please refer to "Chapter 26.4 Positioning Memory".

12.5 Electronic Clutch Function

12.5.1 Electronic Clutch Function

The electronic clutch function is used to engage or disengage the clutch for output from the electronic gear. When the electronic clutch is disengaged, the master axis will be separated from the slave axes and the slave axes not in synchronization with the master axis will come to a stop. When the electronic clutch is engaged, the master axis and slave axes will operate in synchronization.

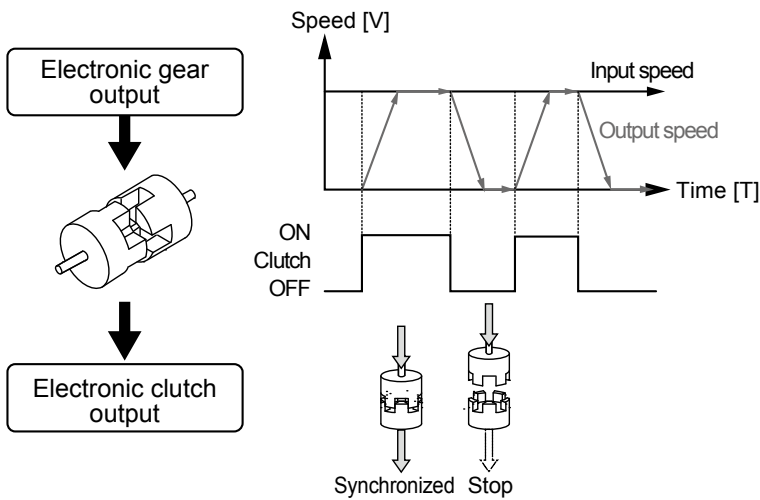

NOTE

Keep in mind that the slave axes may come to a sudden stop if the clutch is disengaged while making a gear ratio change.

12.5.2 Types and Contents of Setting Parameters

The use of the electronic clutch requires the following parameter settings.

Parameter name		Outline
Electronic clutch used/unused		<p>Set to use or not to use the electronic clutch function.</p> <p>The electronic clutch is by default disengaged.</p> <p>Be sure to engage the electronic clutch in response to the operation.</p> <p>The electronic clutch will be always engaged when the electronic clutch is not in use, in which case, output data from the electronic gear will be input as it is into the electronic cam. At that time, the master axis will always operate in synchronization with the slave axes.</p>
Clutch ON	Trigger type	Set an I/O clutch ON request as a trigger to be detected.
	Edge selection	Select the method of trigger signal detection from "Level," "Rising edge," or "Falling edge."
	Method	Select "Direct" or "Slip" for the engagement of the clutch.
	Slip time	If "Slip" is selected, set the slip time.
Clutch OFF	Trigger type	Set an I/O clutch OFF request or "I/O+Phase after clutch" as a trigger to be detected.
	Edge selection	Select the method of trigger signal detection from "Level," "Rising edge," or "Falling edge."
	Method	Select "Direct" or "Slip" for the engagement of the clutch.
	Slip time	If "Slip" is selected, set the slip time.



◆ KEY POINTS

- For the details of the mode to stop at any phase after the clutch OFF (I/O + phase after clutch), refer to "12.5.5 Phase Specification Clutch Off Function".

12.5.3 Trigger Types for Electronic Clutch

The following methods are available for the engagement or disengagement of the electronic clutch.

■ **Clutch request signal (Y1330-Y1337, Y1340-Y1347)**

An I/O signal (clutch request signal) allocated to the unit is in control of the electronic clutch.

■ **I/O Allocation**

Signal name	Axis 1	Axis 2	Axis 3	Axis 4	Axis 5	Axis 6	Axis 7 (virtual)	Axis 8 (virtual)	Operation
Slave axis clutch ON request	Y1330	Y1331	Y1332	Y1333	Y1334	Y1335	Y1336	Y1337	
Slave axis clutch OFF request	Y1340	Y1341	Y1342	Y1343	Y1344	Y1345	Y1346	Y1347	
Slave axis clutch operation annunciation	X1330	X1331	X1332	X1333	X1334	X1335	X1336	X1337	ON: Engaged, OFF: Disengaged

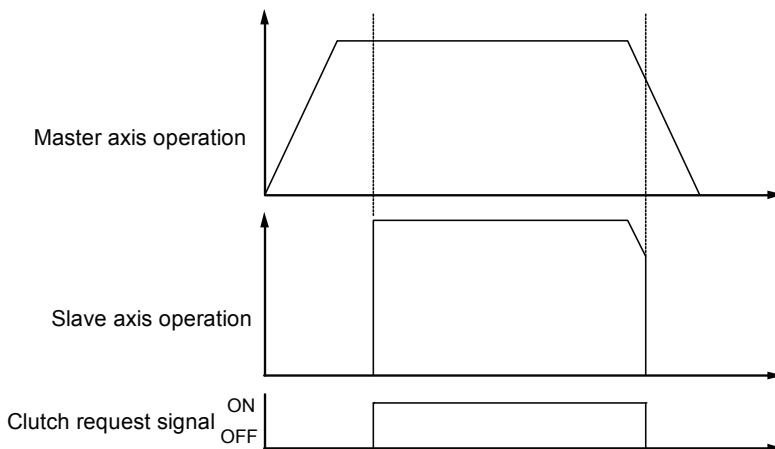

(Note): The above shows an example of the direct method selected for the engagement of the clutch.

■ **Edge selection**

Edge selection	Operation
Level	The clutch operation is switched by turning on or off the slave axis clutch ON request (Y1330-Y1337). The slave axis clutch OFF request signal is not used. When the edge selection is level, the slave clutch OFF request (Y1340-Y1347) is invalid.
Leading edge	The clutch turns ON by the leading edge of the slave clutch ON request (Y1330-Y1337). Also, the clutch turns OFF by the leading edge of the slave clutch OFF request (Y1340-Y1347).
Trailing edge	The clutch turns ON by the trailing edge of the slave clutch ON request (Y1330-Y1337). Also, the clutch turns OFF by the trailing edge of the slave clutch OFF request (Y1340-Y1347).

12.5.4 Engagement Methods of Electronic Clutch

The electronic clutch function engages the clutch to start operating the slave axes and disengages the clutch to stop operating the slave axes, the acceleration or deceleration of the slave axes can be set as shown below.

■ Direct method

This method detects the engagement or disengagement of the clutch to adjust the operating speed of the master axis to coincide with that of the slave axes. In the direct method, the speed of the slave axes with the clutch engaged or disengaged coincides with the operating speed of the master axis with the acceleration and deceleration time set to 0.

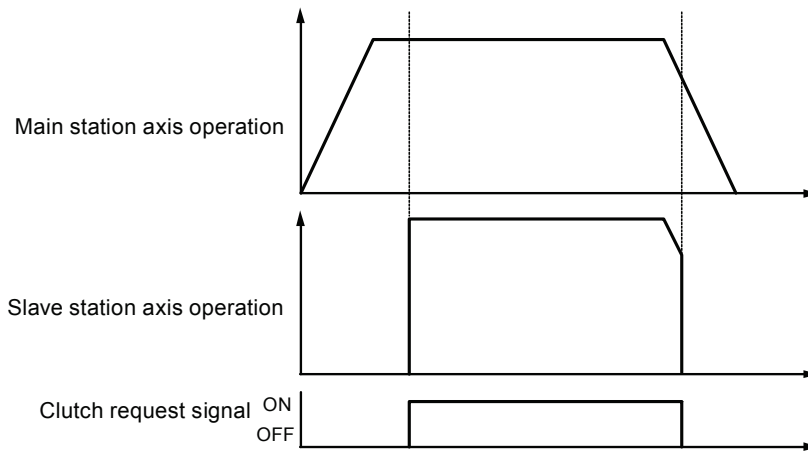

■ Slip method

This method detects the engagement or disengagement of the clutch and set the slip time to acceleration time and deceleration time so that the operating speed of the slave axes to follow the operation speed of the master axis. Linear acceleration and deceleration will apply.

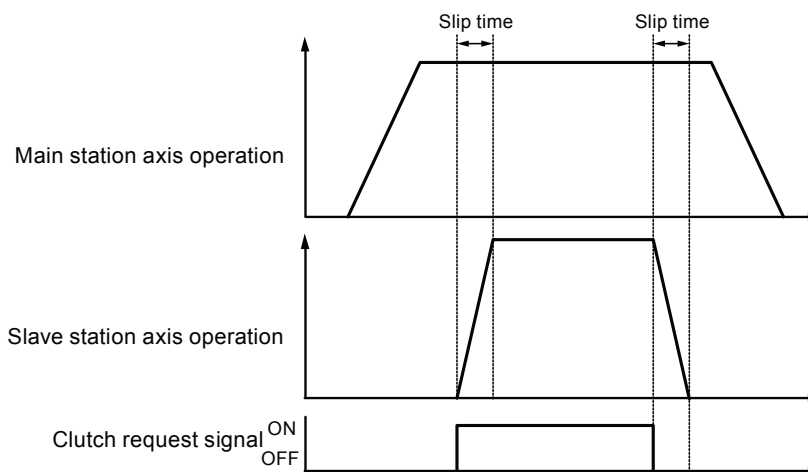

12.5.5 Phase Specification Clutch Off Function

The "phase specification clutch OFF function" is a function for turning off an electronic clutch at an arbitrarily specified phase. For stopping or starting at the same phase repeatedly, the control without variance can be performed.

■ **Phase specification clutch OFF function**

When performing the OFF request by the I/O signal, the clutch off operation will be executed regardless of phase.

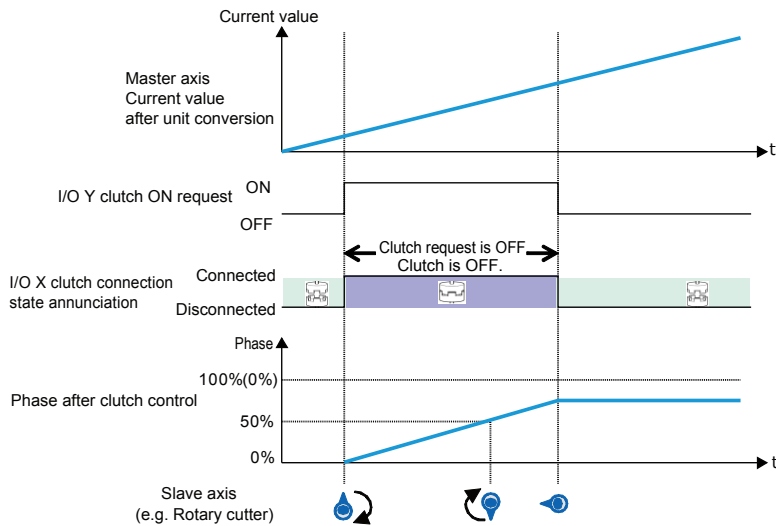

Using the "phase specification clutch off function" turns a clutch off when the phase reaches the set phase after the clutch off request by the I/O signal.

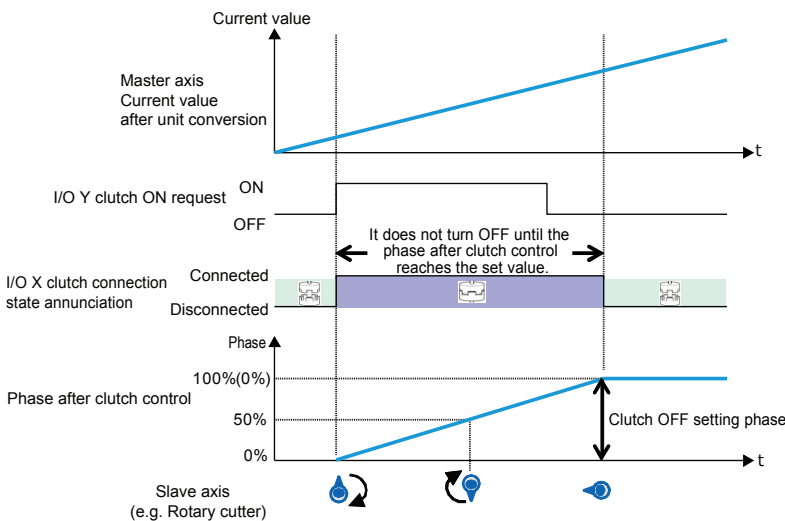

(Note 1): The above figure shows the case that the both clutch on request and off request are set to "Level". Also, either "Rising edge" or "Falling edge" can be selected.

(Note 2): The above figure shows the case that the clutch off setting ratio is set to "0%". It can be set to 0 to 99%.

■ Precautions for operation characteristics

- When setting "Slip" for the clutch off method, the deceleration stop is performed after a specified slip time from the time that the phase reaches the clutch off setting ratio. To stop the motors at the phase of a set ratio, set the clutch off method to "Direct".

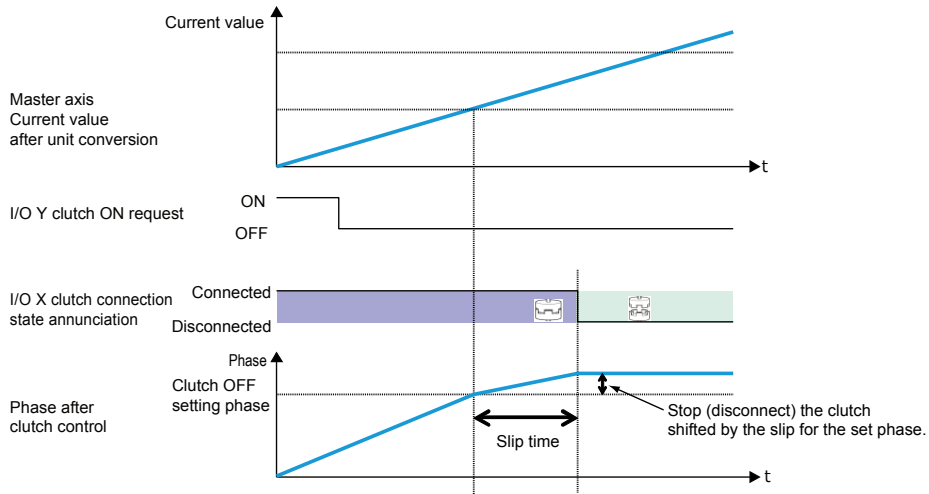

- When the clutch off trigger signal is detected at a phase larger than the set clutch off setting ratio (0 to 99%), the clutch will be off at the next time the signal reaches the set phase.

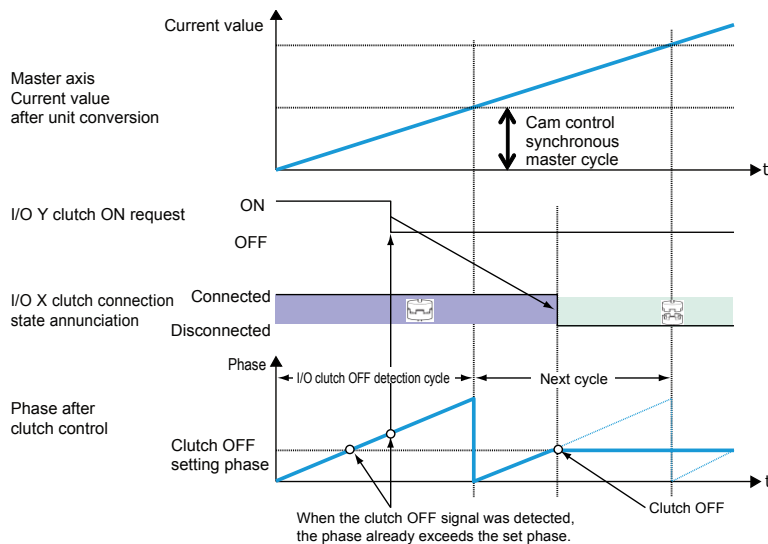

12.6 Electronic Cam Function

12.6.1 Outline of Electronic Cam Function

■ Electronic cam function

The electronic cam function uses a preset cam pattern, determines the movement amount of the slave axes according to the operation of the master axis (phase information) and cam pattern, and outputs the movement amount. The cam pattern uses one rotation of the master axis as an operation reference, based on which the displacement of the slave axes in each phase (rotation angle) is defined on the Configurator screen.

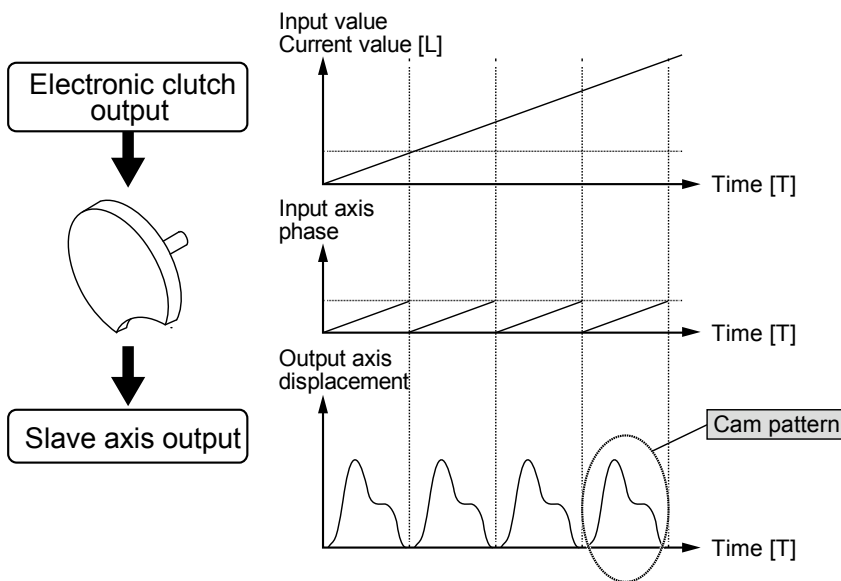

■ Cam pattern

The cam pattern uses one rotation of the master axis as an operation reference, based on which the displacement of the slave axes in each phase (rotation angle) is defined. The cam pattern is defined with the phase (rotation angle) of the master axis based on one rotation as a reference on the X-axis and the displacement on the Y-axis in percent. The cam pattern is set with the desired settings for the positioning unit selected from the Configurator PM7 Configuration screen.

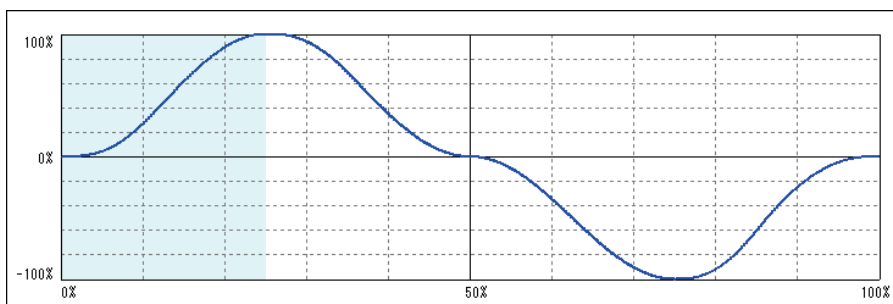

■ Cam pattern specifications

Setting items	Description
Resolution	1024, 2048, 4096, 8192, 16384, 32768
No. of cam patterns	Resolutions of 1024, 2048, 4096, and 8192: 16 Resolution of 16384: 8 Resolution of 32768: 4
Section setting	100%/cycle, 20 sections max.
Displacement setting	100% setting
Cam curve	Selected from the following ones Uniform velocity/Constant acceleration/Simple harmonic motion/Cycloid/Modified trapezoid/Modified sine/Trapezoid One-dwell cycloidal m=1/One-dwell cycloidal m=2/3/One-dwell modified trapezoid m=2/3/One-dwell modified trapezoidal (Ferguson)/One-dwell modified sine/One-dwell trapezoid/No-dwell modified trapezoid/NC2 curve/Asymmetric cycloid/Asymmetric modified trapezoid
Adjustment function	Function to adjust the displacement of desired point data. 1,000 points max. (in units of cam data)
Shift function	Phase shift in created cam data 0% to 100%
Indication	Displacement/Speed/Acceleration/Jerk A check box allows desired display.



◆ REFERENCE

The phases (values) of slave axes are stored in the positioning memory (each axis information area: H20-H21). The values can be read by using F384 (PTBR) instruction. For details of the positioning memory, refer to "26.4.3 Each Axis Information Area (Memory Area No. 1)".

12.6.2 Types and Contents of Setting Parameters

The use of the electronic cam requires the following parameter settings.

Parameter name	Outline
Electronic cam use/non-use	Select the use or non-use of the electronic cam function. When the electronic cam is not used, the electronic cam function will not work, and output from the electronic clutch will be output as pulses.
Cam pattern	The cam pattern is the most fundamental setting for using the electronic cam function. The cam pattern is set in the cam pattern settings window in the FPWIN GR7 Configuration screen. The positioning unit converts cam patterns into point data based on the preset cam curves and resolutions.
Cam control master axis period	Set the number of pulses corresponding to the total phase of the cam pattern used (one-rotation data on the master axis).
Cam pattern number to use	Specify the cam pattern number to be used from cam patterns created.
Cam stroke	Set the number of pulses corresponding to the total displacement (100%) of the cam pattern to use.
Advance angle correction operation setting	Select the use or non-use of the advance angle correction function.
Reference value	The unit follows the unit system of the master axis. Setting range: -2,147,482,624 to 2,147,482,624 (The decimal point position is based on unit systems.)
Reference speed	The unit follows the unit system of the master axis. Setting range: 1 to 2,147,482,624 (The decimal point position is based on unit systems.)
Parameter change time	Setting range: 1 to 10000 ms

12.6.3 Cam Pattern Setting Method

■ Starting Cam Pattern Setting Screen

Open the Configuration screen on the FPCWIN GR7 and select “Positioning settings” so that the setting tool will start.

Select “Axis settings” - “Cam pattern settings” from the toolbar of the setting tool for click the following icon:  The Cam Pattern Settings screen is displayed.

A blank screen will be displayed for a new file and settings for cam pattern 1 will be displayed if data already exists.

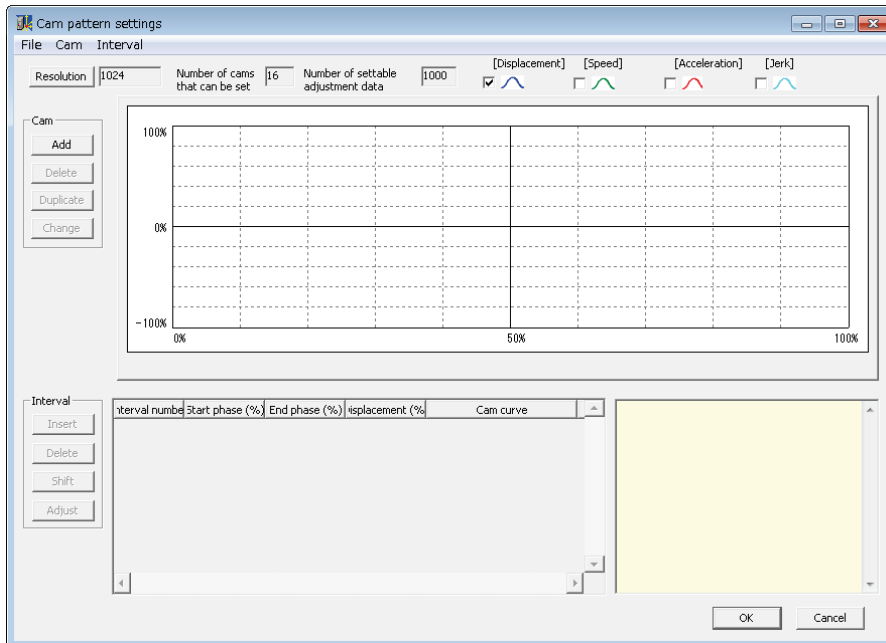

■ Resolution setting

Click the [Resolution] button from the cam pattern menu. After the resolution settings menu is displayed, select the resolution and click the [OK] button.

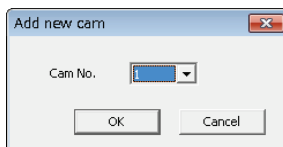



◆ KEY POINTS

- The resolution is valid for all cam patterns. It is not allowed to set the resolution of each cam pattern separately.
- Number of cam patterns available for setting depends on the resolution. When changing the resolution, if the set number of cam patterns exceeds the number of cam patterns available for setting after the resolution is changed, the resolution will not be changed. Please delete the cam patterns and change the resolution again.

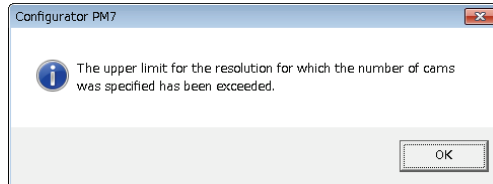

■ Creating/copying cam patterns

Click the [Add] button in the "Cam" field to start the cam no. selection menu.

Select the cam no. and click the [OK] button.

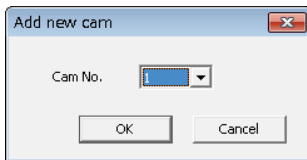

Cam patterns can also be copied. Click [Copy] to select the target and source cam pattern no.

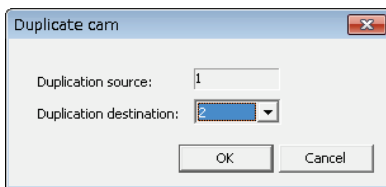

To change the cam no., click the [Change] button and select the changed cam no.

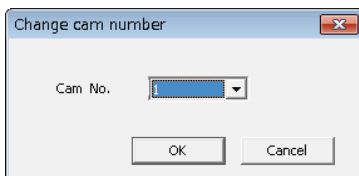

Note) A cam pattern no. that has been set cannot be set.

■ Cam pattern settings

Click the [Insert] button in the "Section" field. Set the starting phase and click the [OK] button.

In the initial status, the cam pattern is only set as a section of the 0~100 phase.

It is allowed to divide the above section into multiple sections by setting the starting phase.

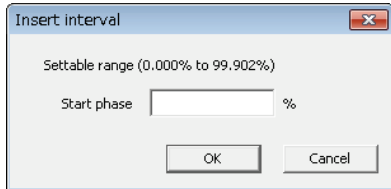

Selected sections are on white background and unselected sections are on gray background.

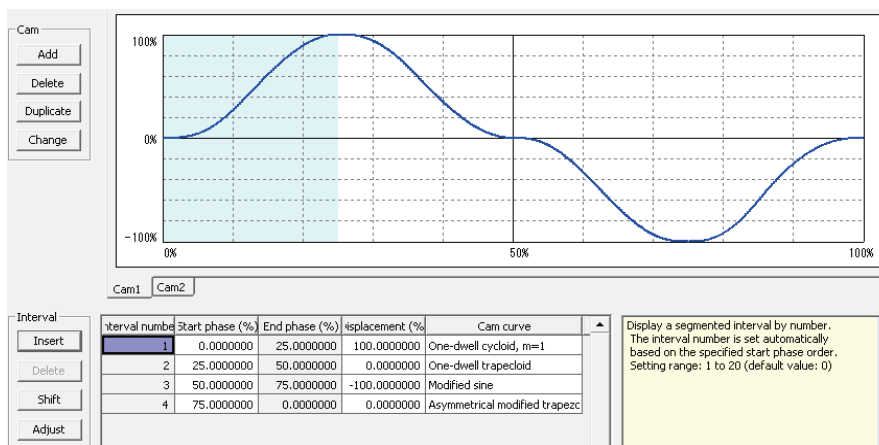

◆ NOTE

- The starting phase may fail to reach the designated phase due to resolution.

■ **Editing of the cam table**

Edit the cam table data that was created.

Set the following items for each section set:

- Starting phase (%)
- Displacement (%)
- Cam curve

The cam curve changes according to the settings.

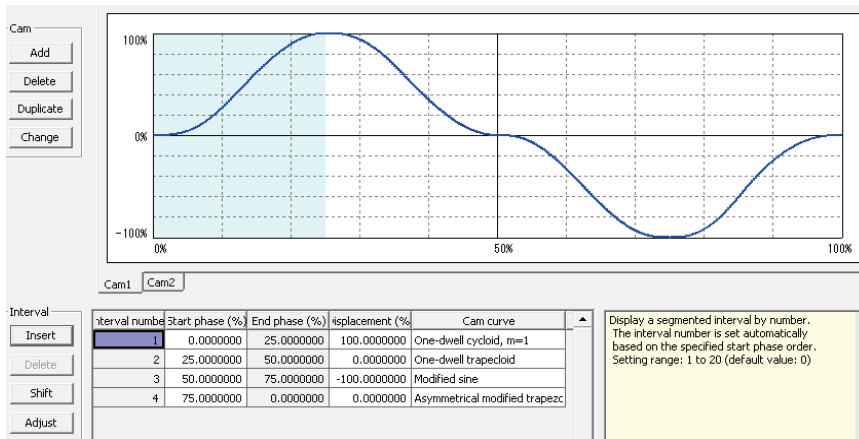

◆ **KEY POINTS**

- **The termination phase cannot be set. The termination phase will be changed automatically if the starting phase is changed.**
- **Do not make a radical displacement change of set cam curves. There is a possibility that the motor cannot keep up with the output in the case of rapid displacement.**
- **Similarly, make settings that a phase of 0% and that of 100% are the same in displacement.**

■ Cam table checks

Check the cam table (cam curve) that has been set. The slave axes in synchronous control operate to follow the cam curve cam. Therefore, there will be a possibility that the motor cannot follow the output if the change in the cam curve is steep. In addition, it is important to know information on the acceleration as well as the displacement of the cam as factors affecting the change of the cam curve. The Cam Table Settings screen can display information on the following items besides the displacement.

Display item	Outline
Displacement	An item set on the cam table.
Speed	The operating speed of the cam table for the amount of displacement that has been set is displayed. The relative value is displayed.
Acceleration	The acceleration in each phase is displayed. Pay attention to points of significant acceleration changes, which involve radical speed changes.
Jerk	Jerk, which is obtained from acceleration differentiated by time, represents the rate of change of acceleration.

Each display item is set by checking the following boxes in the Cam Table Settings screen. Refer to each display item and make setting changes in the cam table.

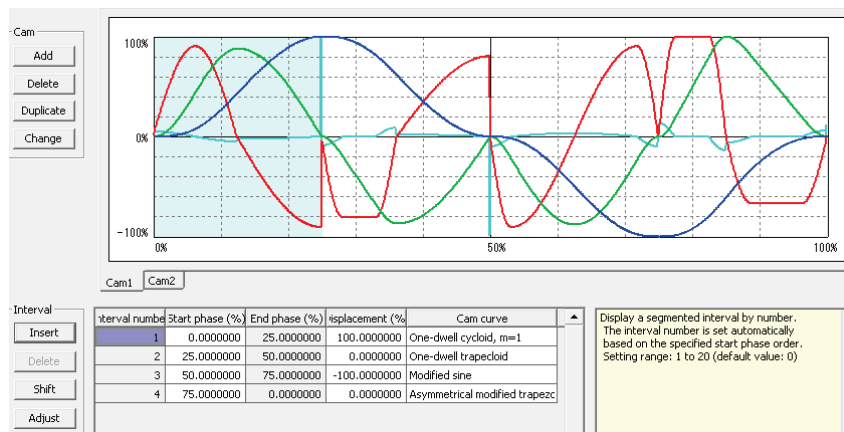
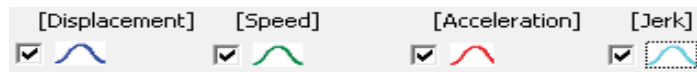

■ Cam table adjustments

The Cam Table settings screen is provided with a function to make the fine-tuning of set cam curve data. In order to mitigate radical changes, this adjustment function makes it possible to fine-tune cam data that has been set. To make adjustments, select the target section number and press the [Adjust] button. The adjustment screen is displayed. The Adjustment screen displays the tables corresponding to the numbers of the designated sections out of all the sections (0% to 100%) divided by the resolution.

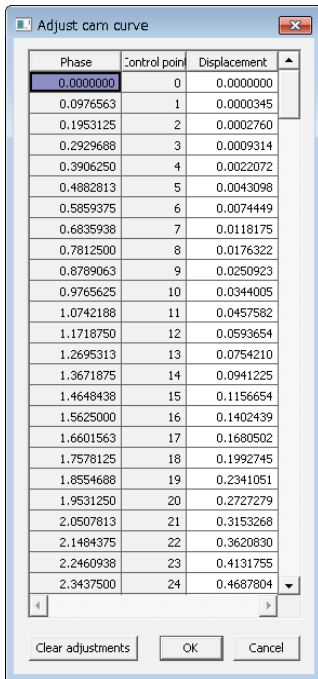

Select the data on the target phases (control points) and change the corresponding displacement data. The adjustments will be reflected by selecting [OK] and the set adjustment data will be cleared by selecting [Adjustment clear]. The numbers of the adjusted sections where the cam curve adjustments have been made are displayed in red, which tells that the adjustments have been completed.

Interval number	Start phase (%)	End phase (%)	Displacement (%)	Cam curve
1	0.0000000	25.0000000	100.0000000	One-dwell cycloid, m=1
2	25.0000000	50.0000000	0.0000000	One-dwell trapezoid
3	50.0000000	75.0000000	-100.0000000	Modified sine
4	75.0000000	0.0000000	0.0000000	Asymmetrical modified trapezoid

■ Cam table shift

The created cam pattern is defined with a phase of 0% to 100%, but the actual operation may differ in phase from the reference of the cam pattern. The cam table shift is a function to set the percentage of the created cam pattern for the phase at a current coordinate position of zero.

Shift image of electronic cam

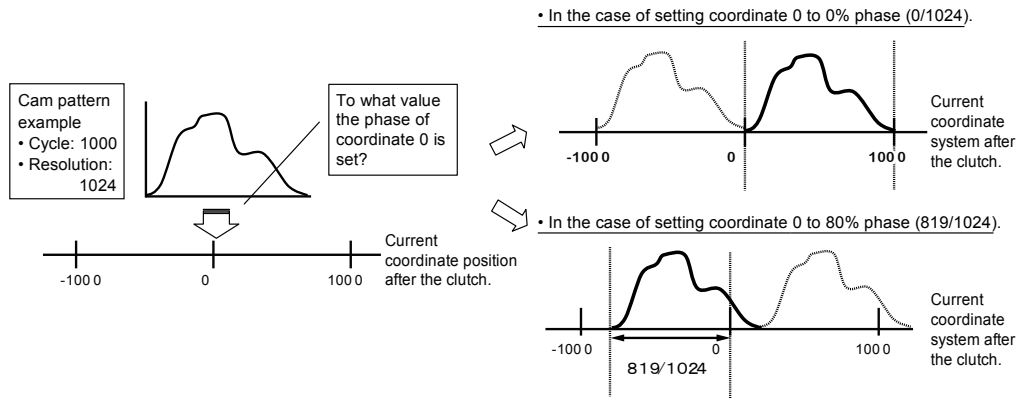

Select the shift from "Interval" and set the shift amount.

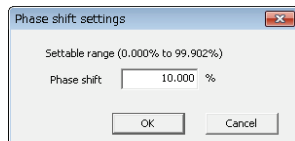

The created cam pattern moved by 10% with the display updated.

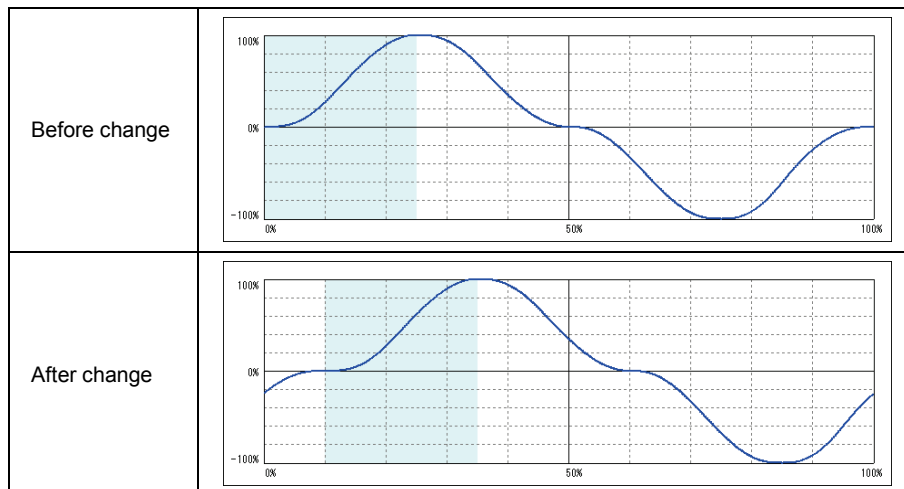

■ Storage of cam tables

Created cam tables can be automatically saved by pressing the [OK] button on the cam table setting screen. Saved cam tables are managed by FPWIN GR7, and set by downloading to control units.

12.6.4 Rewriting Cam Patterns by Programs

The editing function by the programs of cam patterns is a function to execute the change of cam patterns by user programs.

■ Procedure of editing cam patterns

The edit of cam patterns is executed by two operations, which are "Reading cam tables" and "Rewriting cam tables". These operations are performed using a "Cam pattern editing area" in the positioning memory.

(1) Procedure of changing a cam patten that has been set

- ① Read a cam table in the cam pattern editing area.
- ② Change the parameter of the cam table read in the cam pattern editing area.
- ③ Execute rewriting the cam table.

(2) Procedure of creating a new cam pattern

- ① Write parameters of created cam pattern data in the cam pattern editing area.
- ② Execute rewriting the cam pattern data.

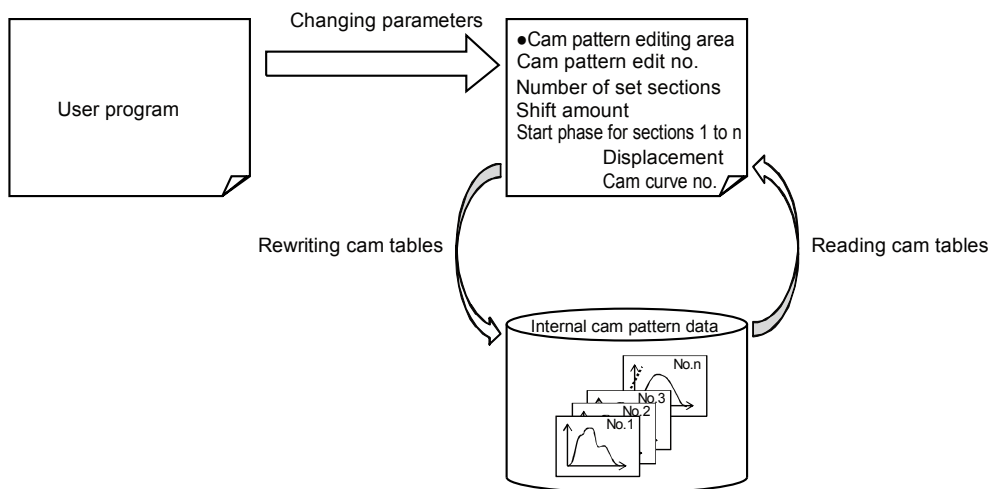

■ Execution conditions of editing cam patterns

The execution conditions for editing cam patterns are as follows.

- The synchronous control is not performed on all axes.
- All axes are not activated.
- Parameters are set correctly.

Also, when request for reading and rewriting are executed simultaneously, reading takes priority. In this case, the execution of the request for rewriting results in an abnormal end (response code: FF21H).

■ Procedure of reading cam pattern data

Step	Operation by user programs and unit operation
①	Set a cam pattern number to be read out to the cam pattern editing area.
②	Turn on the came table reading request (Y1102) from a ladder program.
③	On the completion of reading, turn on the cam pattern reading completion annunciation (X1102) after storing a response code in "Cam table reading result".
④	Once the cam table reading request (Y1102) turns off, the unit turns off the cam pattern reading completion annunciation flag (X1102).

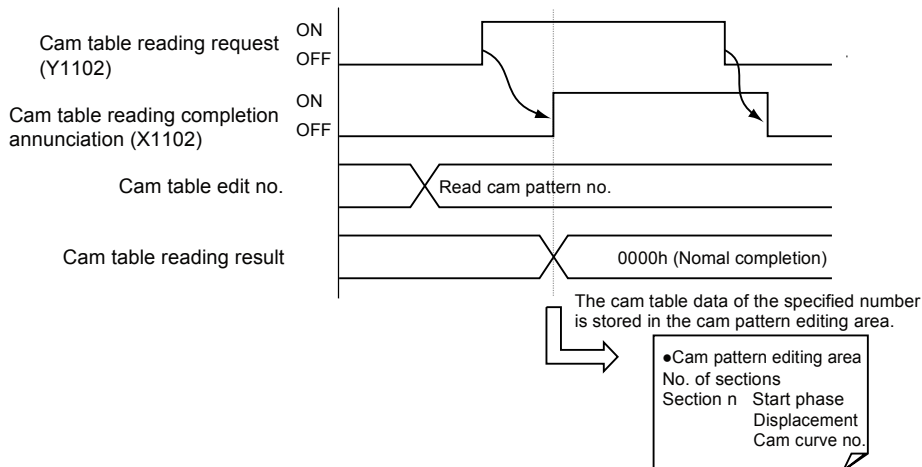

■ Related positioning parameter

Area	Offset address	Name	Default	Description
Cam pattern editing area (No.3)	58H	Cam pattern reading result	H0	<ul style="list-style-type: none"> •Stores the result of reading processing (response code). [Range] (Hexadecimal) 0000H: Normal end Other than 0000H: Abnormal end

■ Procedure of rewriting cam pattern data

Step	Operation by user programs and unit operation
①	Store necessary setting parameters in the cam pattern editing area. <ul style="list-style-type: none"> ● Rewriting cam pattern number ● No. of sections: following parameters in sections 1 to n (n is a specified number of sections.) ● Start phase ● Displacement ● Cam curve number
②	Turn on the came table rewriting request (Y1103) from a ladder program.
③	On the completion of rewriting, turn on the cam pattern rewriting completion annunciation (X1103) after storing a response code in "Cam table rewriting result".
④	Once the cam table rewriting request (Y1103) turns off, the unit turns off the cam pattern rewriting completion annunciation flag (X1103).

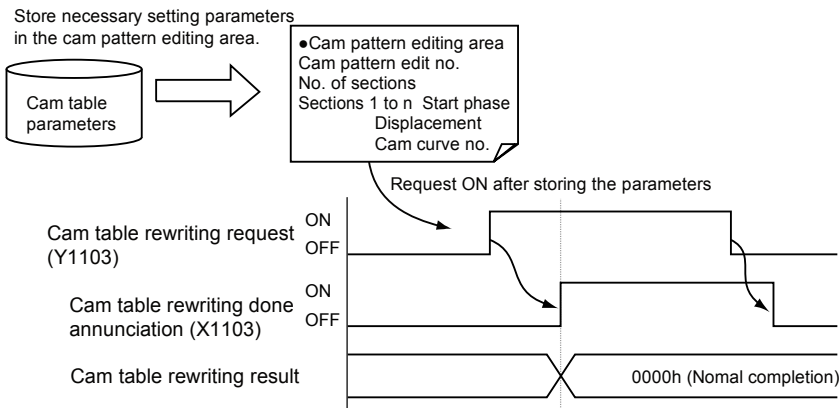

■ Related positioning parameter

Area	Offset address	Name	Default	Description
Cam pattern editing area (No.3)	59H	Cam pattern rewriting result	H0	·Stores the result of rewriting processing (response code). [Range] (Hexadecimal) 0000H: Normal end Other than 0000H: Abnormal end

■ Sample program

- The following program shows the case that the phase, displacement and the type of curve is changed in the section 3 of the cam table number 2. The first axis is set to the master axis, and the 2nd to 8th axes are set to slave axes.
- Execute the synchronous cancel operation is executed for all the slave axes (axes 2 to 8). Confirm if all slave axes (axes 2 to 8) are not in the synchronous control and all axes are not activated.
- Read the cam table, and change and rewrite the parameters.

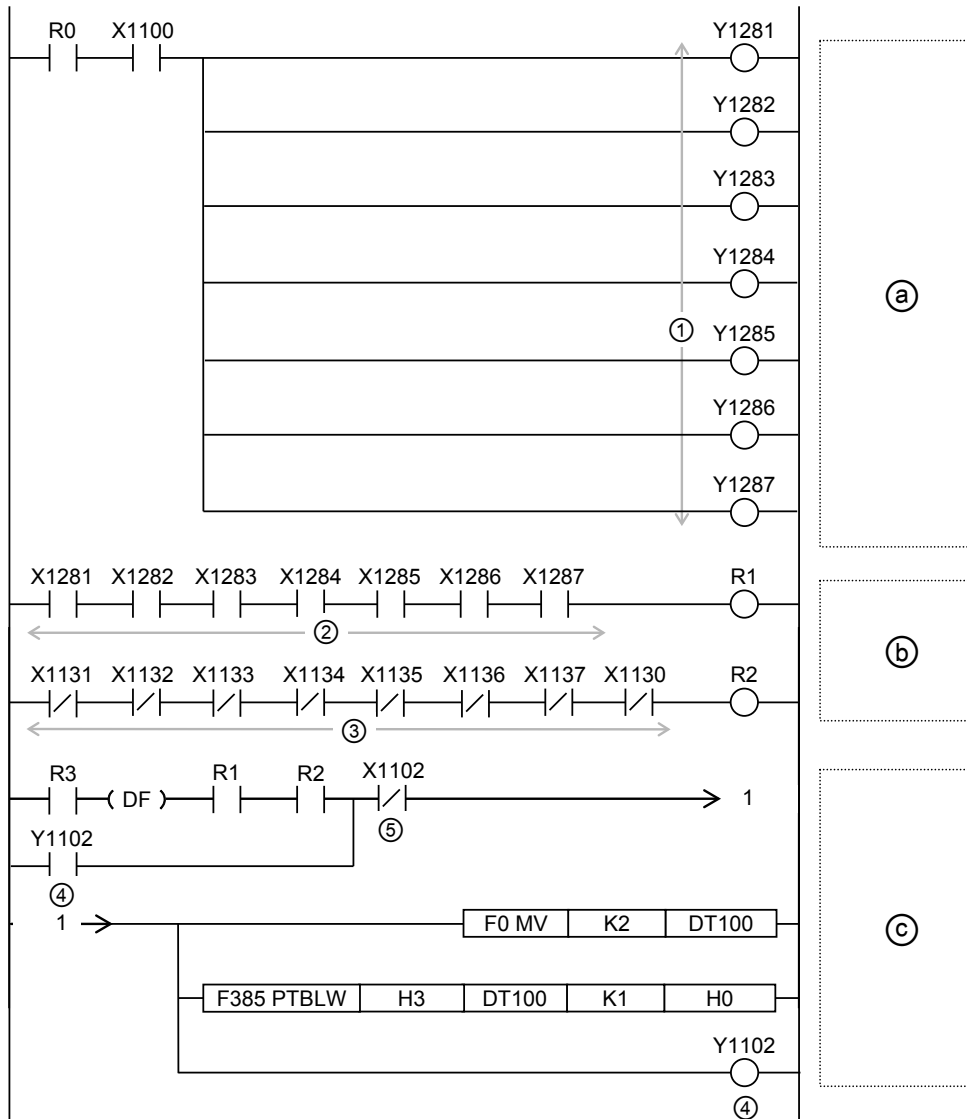

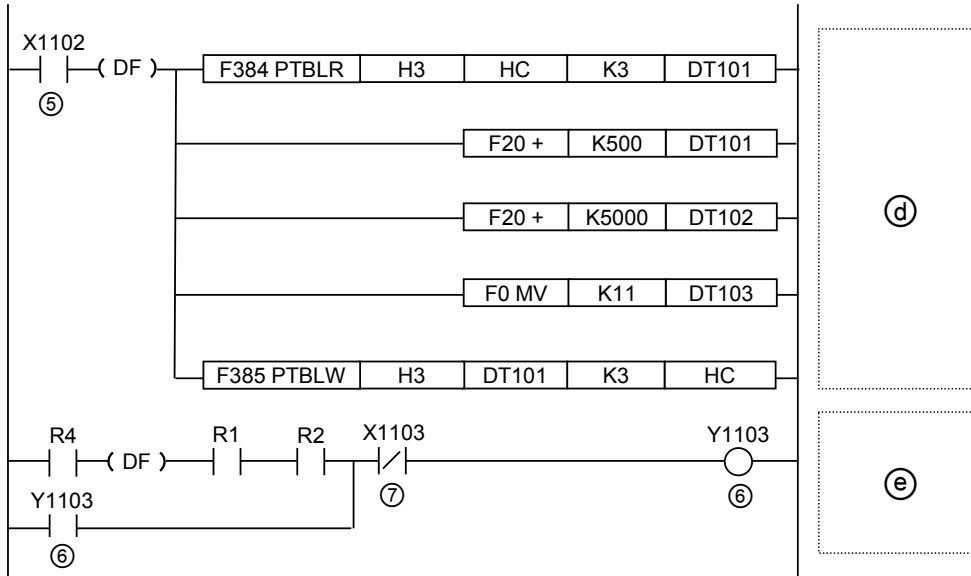

Code	Content specified by program	Description
Ⓐ	Synchronous control cancel for all axes	Cancels the synchronous control for all slave axes.
Ⓑ	Confirmation of execution permission condition	Confirms that all slave axes are not in the synchronous control and all axes are stopped.
Ⓒ	Cam table reading start	Specifies a cam pattern number, and performs a reading request (Y1102).
Ⓓ	Parameter change in cam table editing area	Edits the cam table data in the section 3 after the completion of reading the cam table. In this example, start phase + 5%, displacement + 50%, and cam curve are set to constant acceleration.
Ⓔ	Cam table rewriting start	Performs the rewriting to a specified cam pattern data.

Code	Content specified by program	Value specified in program							
		Axis 1	Axis 2	Axis 3	Axis 4	Axis 5	Axis 6	Axis 7 (virtual)	Axis 8 (virtual)
①	Synchronous cancel request	Y1280	Y1281	Y1282	Y1283	Y1284	Y1285	Y1286	Y1287
②	Synchronous cancel active annunciation	X1280	X1281	X1282	X1283	X1284	X1285	X1286	X1287
③	BUSY	X1130	X1131	X1132	X1133	X1134	X1135	X1136	X1137
④	Cam table reading request	Y1102							
⑤	Cam table reading completion	X1102							
⑥	Cam table rewriting request	Y1103							
⑦	Cam table rewriting completion	X1103							

■ Precautions for rewriting cam patterns by program

- Even if cam pattern data is rewritten by this function, the cam pattern data of positioning parameters will not be updated.
- It will be rewritten again to a cam pattern set on Configurator PM7 when the power turns on or configuration data is written and the PROG mode changes to RUN mode. As necessary, execute the rewriting of the cam pattern again by a program.
- It is possible to confirm whether the cam pattern has been rewritten to the data of positioning parameters by a "cam pattern update flag".
- When performing a reading request specifying an unregistered cam pattern number, all the read data will be "0".
- When performing a rewriting request while no cam is registered (a resolution is undetermined), rewriting will be performed considering the resolution as 1024.
- Cam adjustment data set on Configurator PM7 cannot be used. Also, when executing the rewriting, the adjustment data before the rewriting will be initialized.



◆ REFERENCE

- For the details of "cam pattern update flag", refer to "26.4.5 Cam Pattern Editing Area (Memory Area No. 3)".

■ Precautions when using phase shift amount

- ① Specify the values when the phase shift amount is 0(%) for the parameter values of cam pattern (starting phase, displacement and cam curve).
- ② The starting phase of the section number 1 is 0(%). When any values other than 0(%), an error will occur. For starting phases after the section number 2, specify arbitrary starting phases. When reading and writing settings, the closest phase will be automatically calculated within the unit from the resolution.
- ③ After setting the cam pattern when the phase shift amount is 0(%), set a phase shift amount. When reading and writing settings, the closest phase amount will be automatically calculated within the unit from the resolution.

For rewriting the cam pattern set on the tool software Configurator PM7 to a user program, perform the following procedure.

- ⑤ Record the phase shift amount specified on Configurator PM7.
- ⑥ The phase shift amount has been added to the starting phase displayed on Configurator PM7. Set the phase shift amount to 0(%) to confirm the parameter values of cam pattern (starting phase, displacement, cam curve).
- ⑦ Use the parameter values acquired in 6 on user programs. As for the starting phase, use values to two decimal places.
- ⑧ Set the phase shift amount recorded in 5. As well as the starting phase, use values to two decimal places.

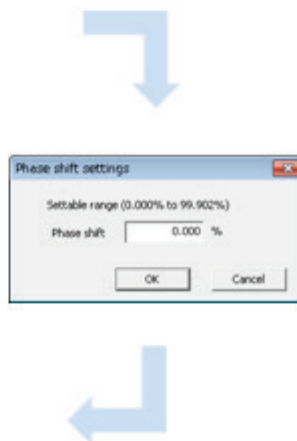
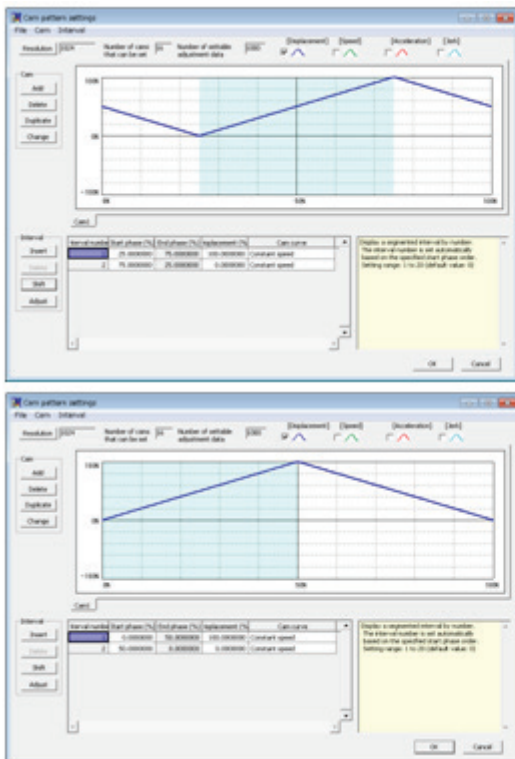

12.6.5 Advance Angle Correction Function

"Advance angle correction function" is a function to correct the delay in the response of a machine system connected to an electronic cam output or the delay in a PLC arithmetic processing time. This function is available for the unit of Ver.1.5 or later.

■ Specification of advance angle correction amount

- Advance angle correction amounts are specified for each slave axis using a tool software or user program.
- By setting "advance angle correction reference speed" and "advance angle correction reference amount", a correction amount is automatically calculated using an active "master axis input speed". The advance angle correction amount is calculated by the following formula.

$$\text{Advance angle correction amount} = \text{Master axis input speed} \times \frac{\text{Advance angle correction reference amount}}{\text{Advance angle correction reference speed}}$$

Master axis input speed: Speed information after clutch control

■ Internal processing of advance angle correction

The phase of the master axis which will be a reference of slave axis correction is obtained as operation data for according to the set values of advance angle amount. A correction amount for each slave axis is calculated based on this value as a reference.

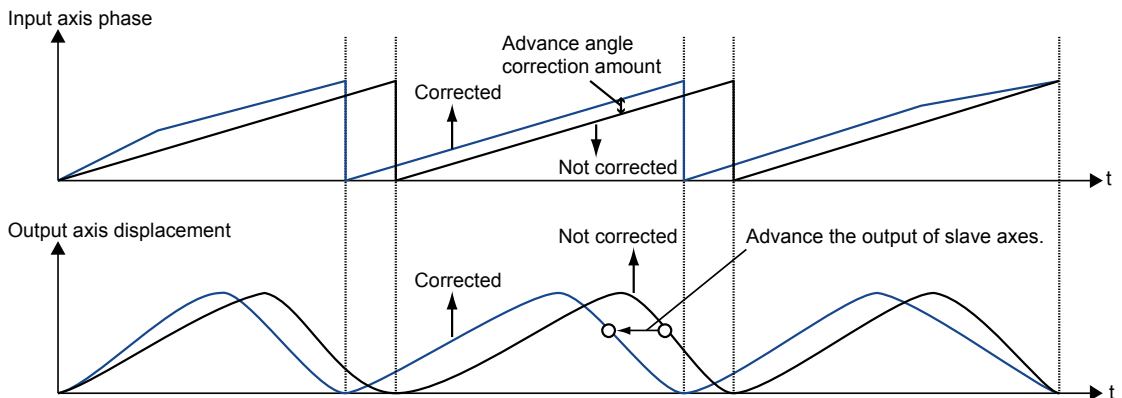

➡ To the next page

■ **Setting with tool software**

Set in the synchronous control setting dialog box.

Electronic cam operation settings	Use
Cam control synchronization master period	1
Cam pattern number to use	1
Cam stroke	1
Advance angle correction operation setting	Use
Reference value	0
Reference speed	100
Parameter change time	100

Parameter name	Overview
Advance angle correction operation setting	Select the use or non-use of the advance angle correction function.
Reference amount	The unit follows the unit system of the master axis. Setting range: -2,147,482,624 to 2,147,482,624 (The decimal point position is based on unit systems.)
Reference speed	The unit follows the unit system of the master axis. Setting range: 1 to 2,147,482,624 (The decimal point position is based on unit systems.)
Parameter change time	Setting range: 1 to 10000 ms

■ **Setting with user programs**

The following examples shows the case that the advance angle correction reference value of 1st axis is changed to 50 and the advance angle correction reference speed to 3000.

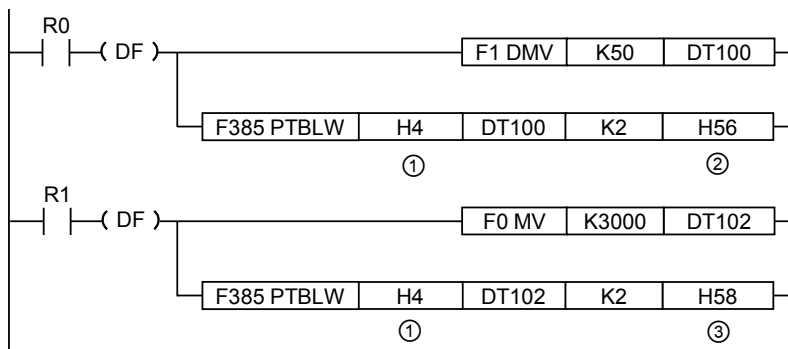

Code	Content specified by program	Value specified by program							
		Axis 1	Axis 2	Axis 3	Axis 4	Axis 5	Axis 6	Axis 7 (virtual)	Axis 8 (virtual)
①	Axis no. and synchronous control setting area	H4	H104	H204	H304	H404	H504	H604	H704
②	Advance angle correction reference amount setting area	H56							
③	Advance angle correction reference speed setting area	H58							

■ Changing the advance angle correction amount during operation

- The advance angle correction amount can be changed during operation.
- After the detection of the change in "advance angle correction reference speed" or "advance angle correction reference amount" by the unit, the advance angle correction amount will be reflected after the elapse of a specified "advance angle correction change time".

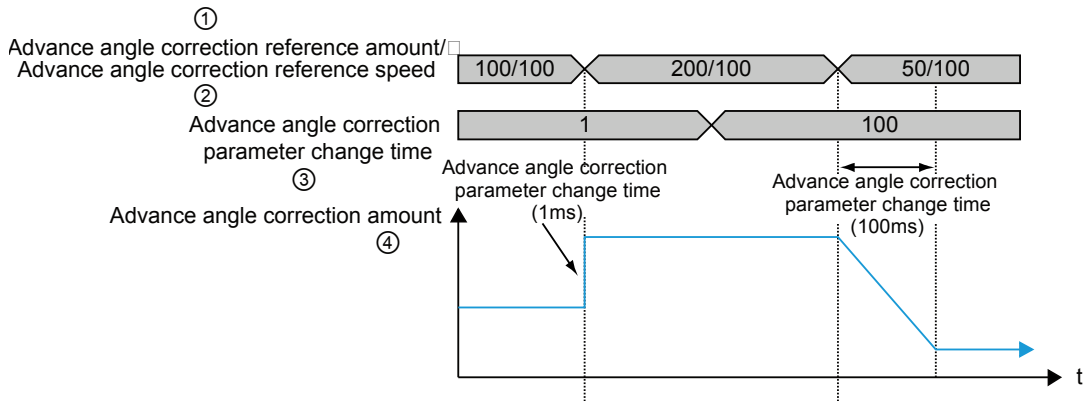

◆ NOTES

- "Advance angle correction reference speed" and "Advance angle correction reference amount" are signed 32-bit data. If they are changed by 16-bit (1-word) unit, they may be changed to unintended values. Always perform the rewriting by 32-bit (2-word) unit.
- When changing an "advance angle correction reference speed" or "advance angle correction reference amount" during operation, the timing that the unit acquires the changed "advance angle correction reference speed" or "advance angle correction reference amount" may deviate. Change either parameter of "advance angle correction reference speed" or "advance angle correction reference amount" to prevent the "advance angle correction amount" from being rapidly changed.

■ Precautions for settings

- Overshoot or undershoot may occur according to settings when sufficient acceleration/deceleration time is not set for the start or stop of master axis while the advance angle correction function is used, or when an input speed is rapidly accelerated or decelerated by the direct connection or disconnection of a clutch while the master axis is operated.
- When using the advance angle correction function, set a sufficient acceleration/deceleration time on the master axis. When using the clutch function in combination, make the setting to prevent the occurrence of a rapid acceleration or deceleration using the slip function.

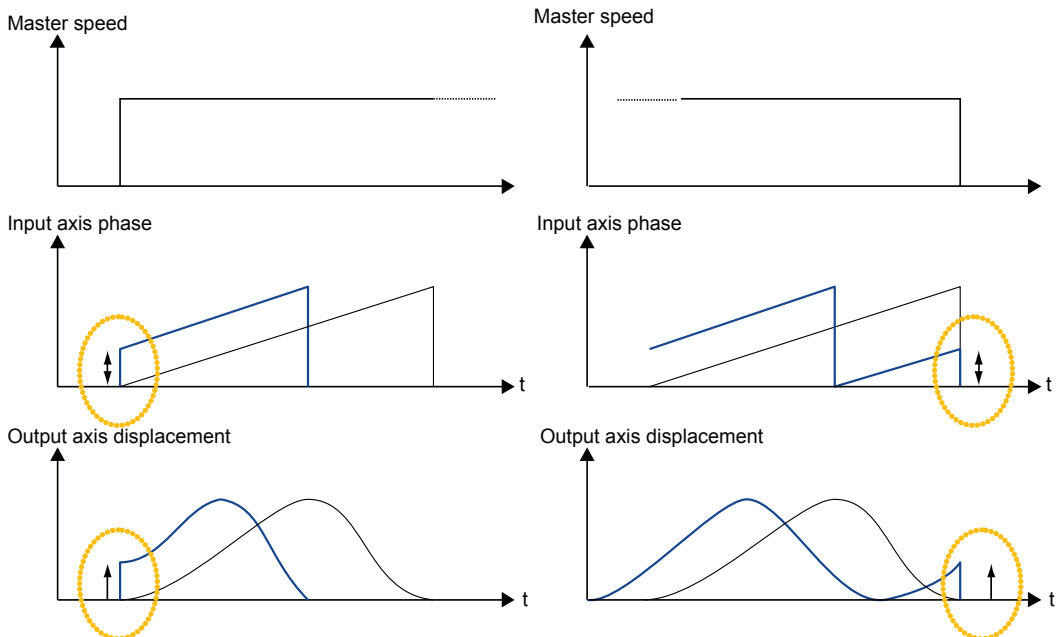

- Depending on the setting of "advance angle correction reference speed" or "advance angle correction reference amount", a calculated advance angle correction amount may exceed the "cam control synchronous master axis cycle". When the advance angle correction amount exceeds the "cam control synchronous master axis cycle", the "synchronous cam master axis cycle" will be the upper limit as below. Set the parameter of advance angle correction which meets an input speed.

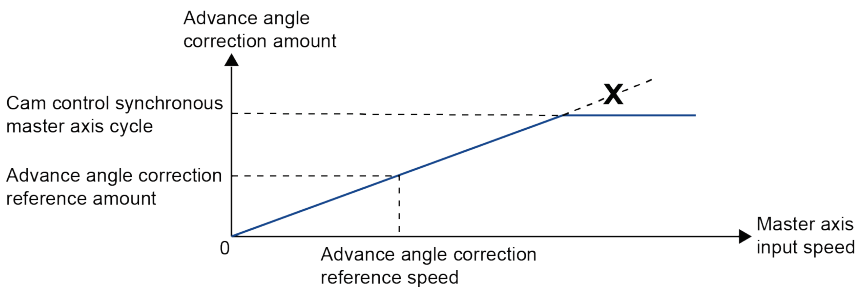

13

Manual Operation (JOG Operation)

13.1 Setting and Operation of JOG Operation

The following example is explained with the JOG operation of axis-1. Settings are made in pulses.

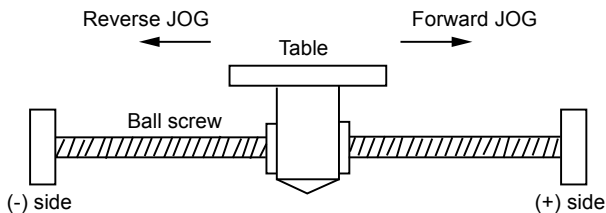

■ Settings

Parameters required for the JOG operation of the positioning unit is set in the positioning setting menu of the programming tool.

Items	Setting example
Acceleration/deceleration pattern	0: Linear acceleration/deceleration
Acceleration time (ms)	100 ms
Deceleration time (ms)	100 ms
Target speed	10000 pps

■ Operation diagram

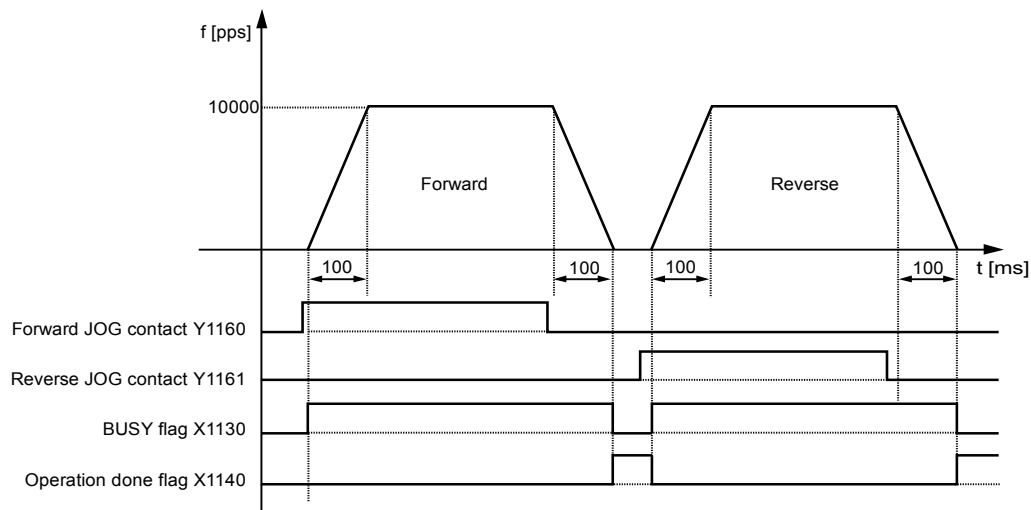

■ Operation of each contact

- The BUSY flag (X1130), which indicates that the motor is running, will turn ON when the positioning control starts, and it will turn OFF when the operation completes.
- The operation done flag (X1140), which indicates the completion of operation, will turn ON when the current operation is completed, and it will be held until the next positioning control, JOG operation, home return, or pulser operation starts.

■ Sample program

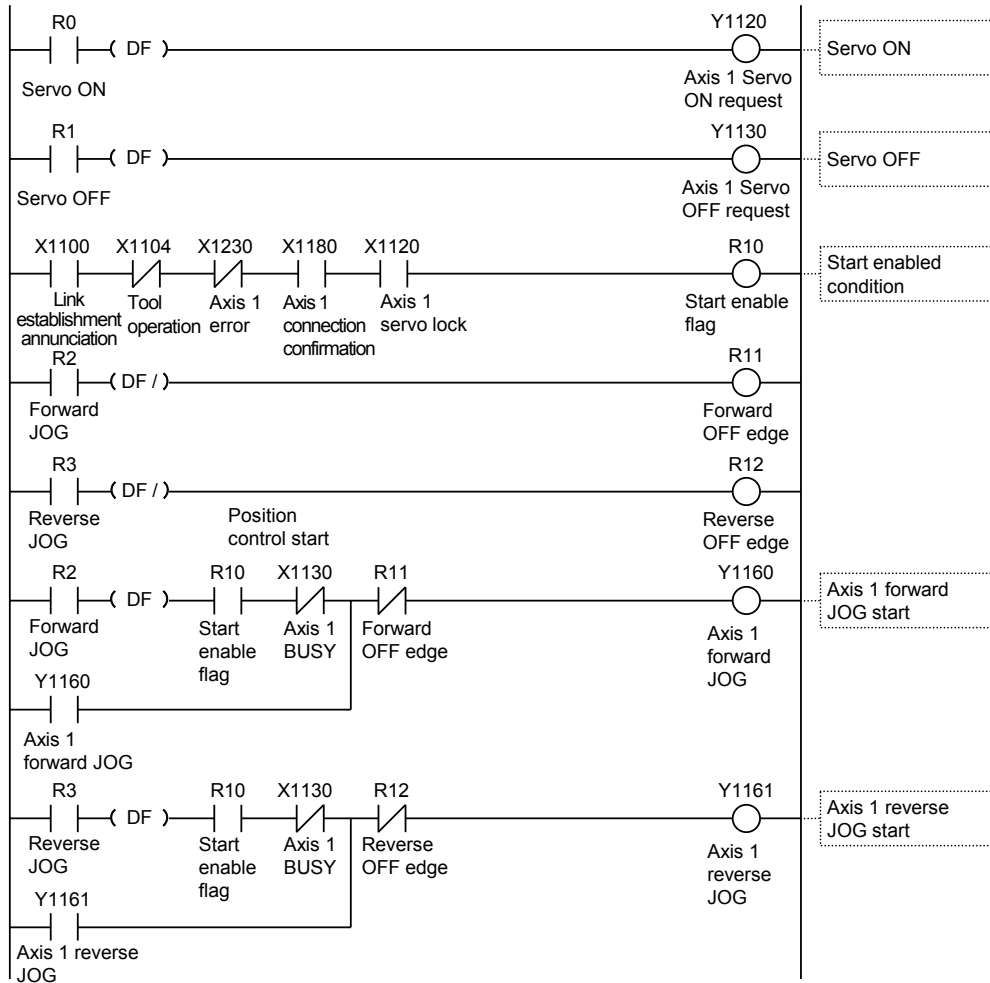

■ Programming precautions

The starting point and flag number vary with the axis number.

■ Operation at limit input

Condition	Direction	Limit status	Operation
When JOG operation is executed	Forward rotation	Limit input (+): ON	Not executable, Error occurs
		Limit input (-): ON	Executable
	Reverse rotation	Limit input (+): ON	Executable
		Limit input (-): ON	Not executable, Error occurs
During JOG operation	Forward rotation	Limit input (+): ON	Deceleration stop, Error occurs
	Reverse rotation	Limit input (-): ON	Deceleration stop, Error occurs

13.2 Speed Change During Operation

The target speed can be changed while the positioning unit is in JOG operation.

■ Settings

Parameters required for the JOG operation of the positioning unit is set in the positioning setting menu of the programming tool.

Items	Setting example	
Acceleration/deceleration pattern	0: Linear acceleration/deceleration	
Acceleration time 1 (ms)	100 ms	
Deceleration time 1 (ms)	50 ms	
Target speed 1	10000 pps	
Acceleration time 2 (ms)	200 ms	The set values of acceleration time, deceleration time, and target speed after the speed change are written to the unit memory by the program.
Deceleration time 2 (ms)	150 ms	
Target speed 2	20000 pps	

■ Operation diagram

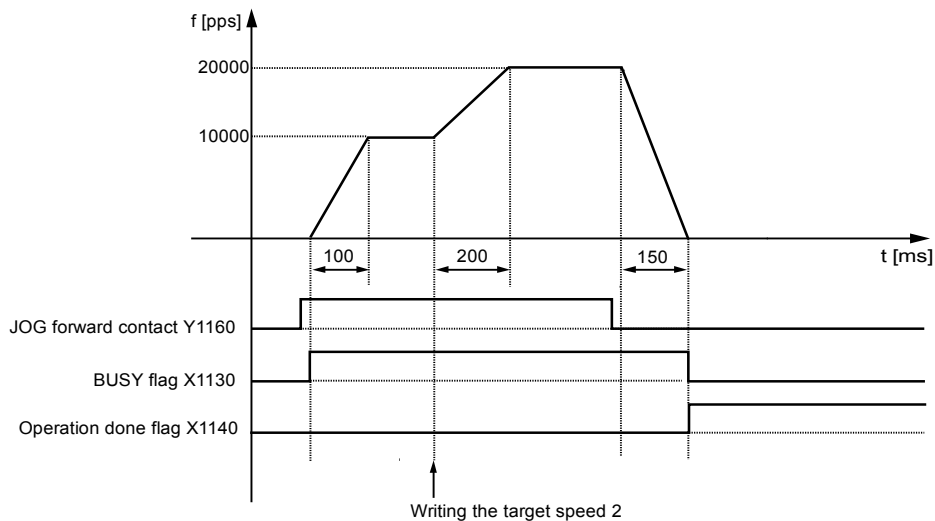

■ Operation of each contact

- The BUSY flag (X1130), which indicates that the motor is running, will turn ON when the Jog operation starts, and it will turn OFF when the operation completes.
- The target speed can be changed freely while the positioning unit is in JOG operation. Use a program to change the target speed.
- The operation done flag (X1140), which indicates the completion of operation, will turn ON when the current operation is completed, and it will be held until the next positioning control, JOG operation, home return, or pulser operation starts.

■ Sample program

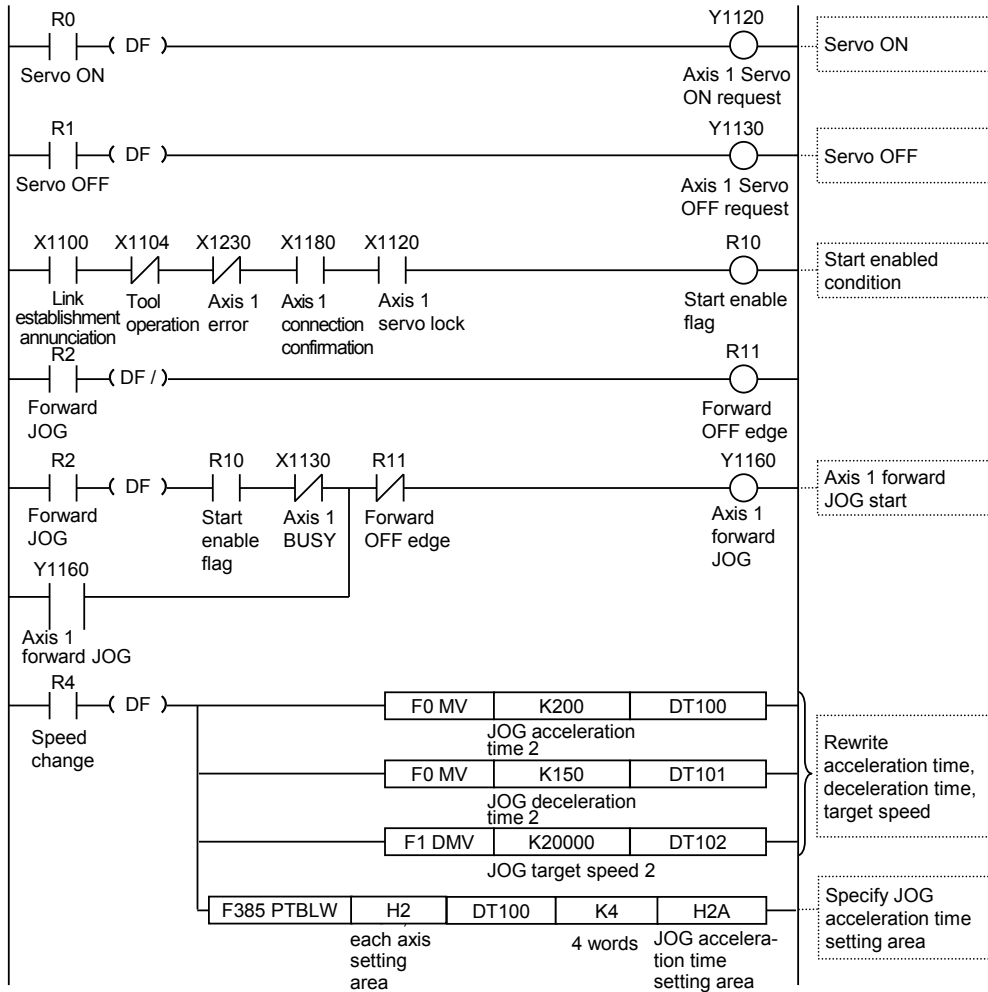

■ Programming precautions

- To change the JOG operation speed, use a user program and rewrite the unit memory (H2A-H2D). The following contents are set with user programs at each addresses of the positioning memory; (H2A: JOG acceleration time, H2B: JOG deceleration time, H2C-H2D: target speed)
- The starting point and flag number vary with the axis number.

14

Manual Operation (Home Return)

14.1 Type of Home Return

The home return is a function to move the current position to the reference origin and set the coordinates as 0.

There the following home return modes for your selection.

■ DOG method 1 (Edge detection of near home switch + First rising edge of home position as reference)

The first rising edge of home position (Z phase) is detected after detecting the rising edge of the near home switch (DOG). It becomes the start point.

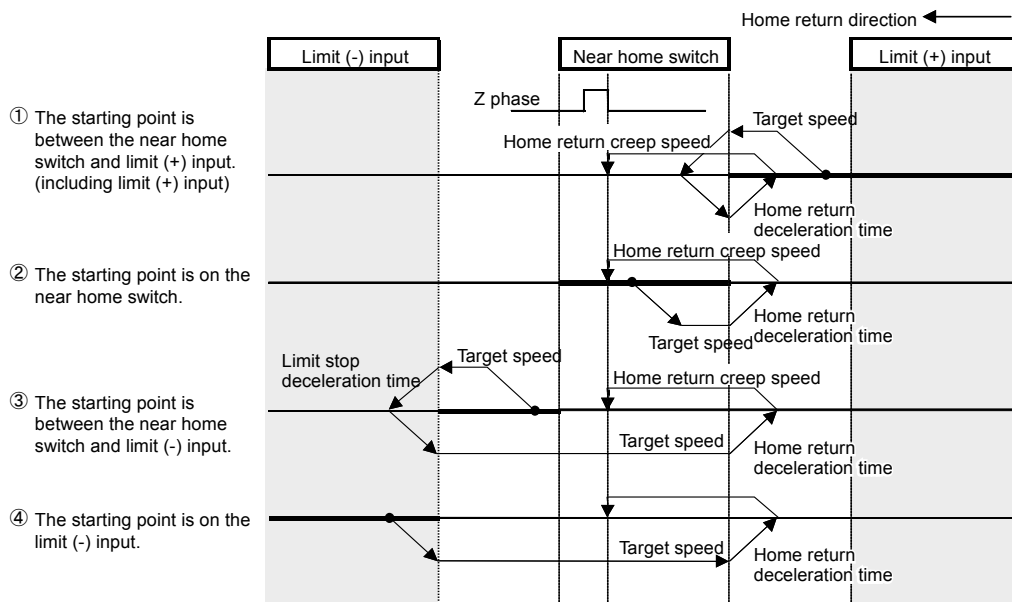

Note) When the home sensor is ON at startup, the operation is similar to ②.

■ **DOG method 2 (Edge detection of near home switch)**

The rising edge of the near home switch (DOG) is detected. It becomes the start point.

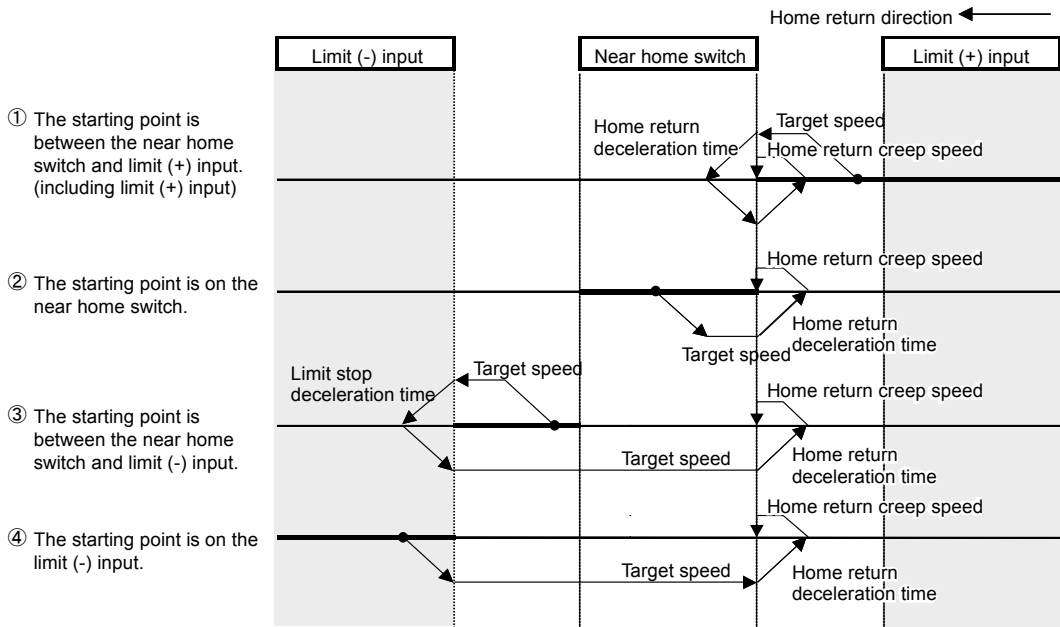

■ **DOG method 3 (Edge detection of near home switch + Falling edge of home position as reference)**

The falling edge of the near home switch (DOG) is detected. The first rising edge (Z phase) of the home switch in the home return direction becomes the start point.

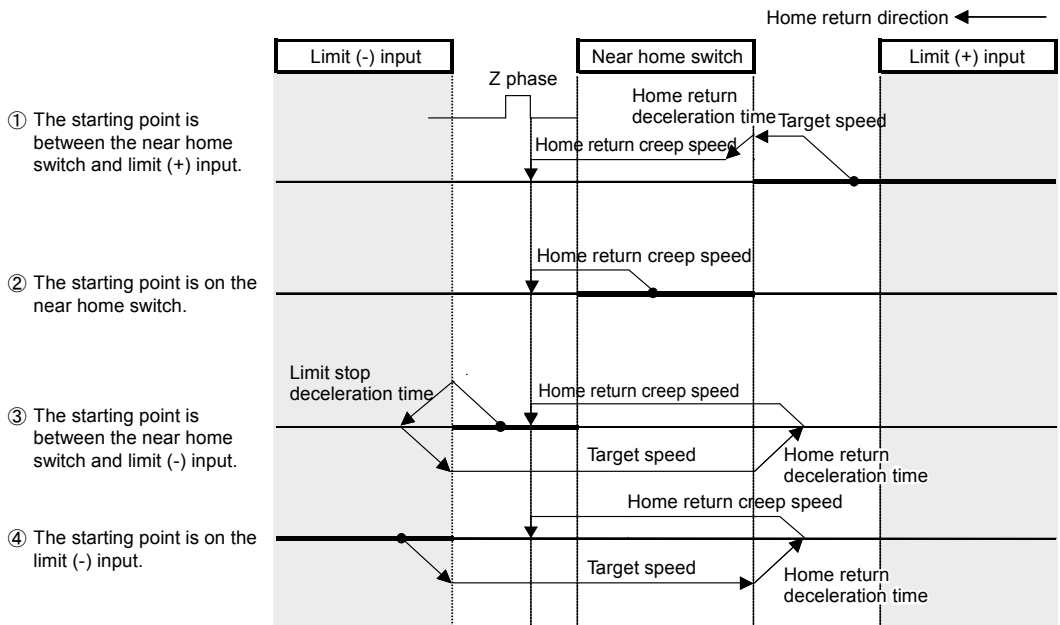

Note) When the home sensor is ON at startup, the operation is similar to ③.

■ Limit method 1 (Edge detection of limit switch + First rising edge of home position as reference)

Reverses after detecting the rising edge of the limit switch on the opposite side of the home return direction. The first rising edge of the home switch is detected. It becomes the start point.

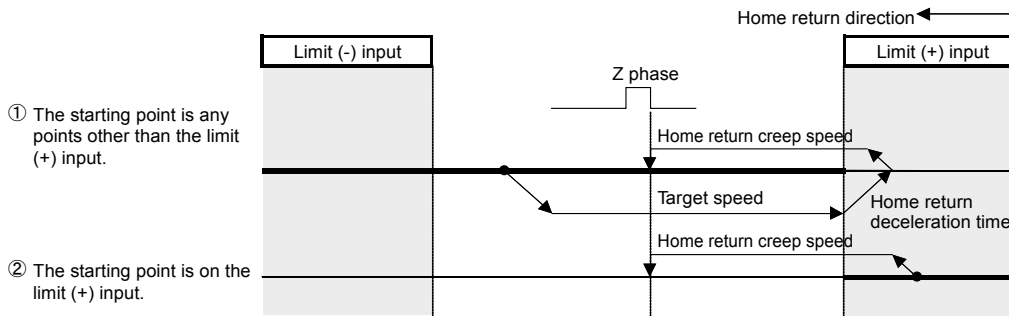

■ Limit method 2 (Edge detection of limit switch)

Detects the rising edge of the limit switch in the home return direction and stops. That point becomes the start point.

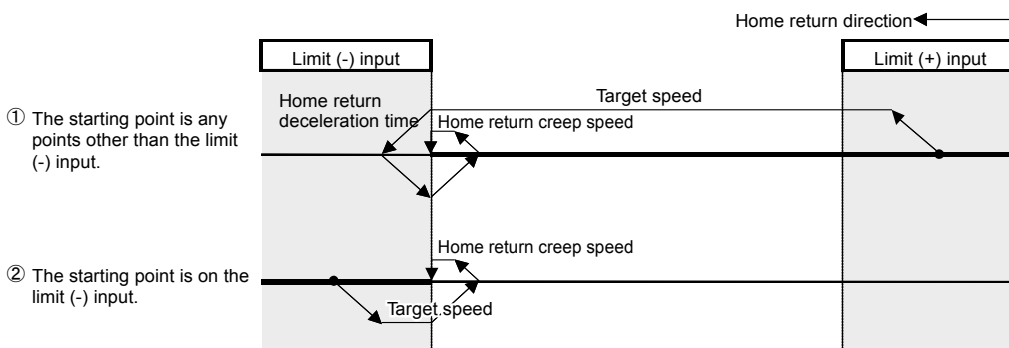

■ Z phase method (Edge detection of home switch)

Moves from the current position in the home return direction, and detects the first rising edge of the home switch and stops. That point becomes the start point.

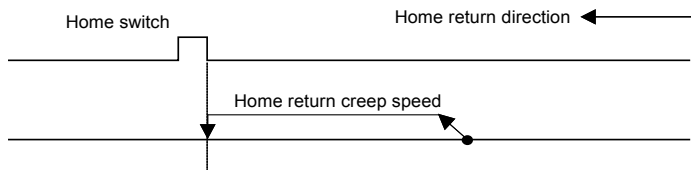

Note) When the home sensor is ON at startup, the unit does not detect the home sensor and operates to the home return direction.

■ Stop-on-contact method 1

The position reached after a constant time has passed at the torque value higher than a specified value using an automatic stop mechanism such as a stopper is regarded as a home position.

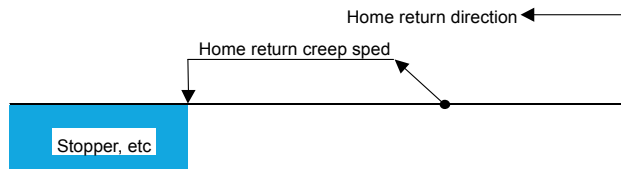

■ Stop-on-contact method 2

Performs the reverse operation after the stop by a stopper and stops at the position where the first home position (Z phase) is detected although the operation is similar to the stop-on-contact method. This position is set as a home position.

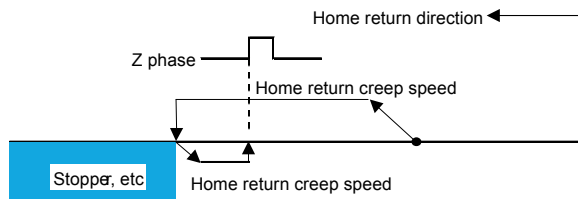

■ Data setting mode

Set the current value as a home position.

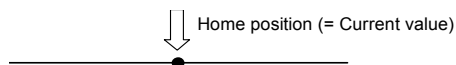

14.2 Setting and Operation of Home Return

The following example is explained with the home return of axis-1. Settings are made in pulses.

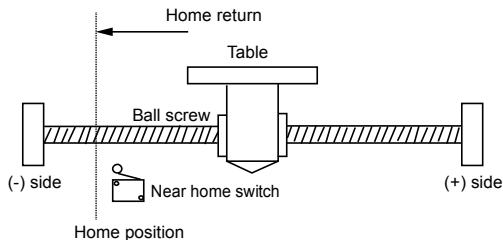

■ Settings

Parameters required for setting home return are set in the position control menu of the programming tool.

Item	Setting Example
Reset setting code	0: DOG mode 1
Reset direction	0: Reset (-) direction
Acceleration time (ms)	100 ms
Deceleration time (ms)	100 ms
Target speed	10,000 pps
Reset creep speed	1000 pps
ON time of the deviation counter removal signal	1000 pps

■ Operation diagram

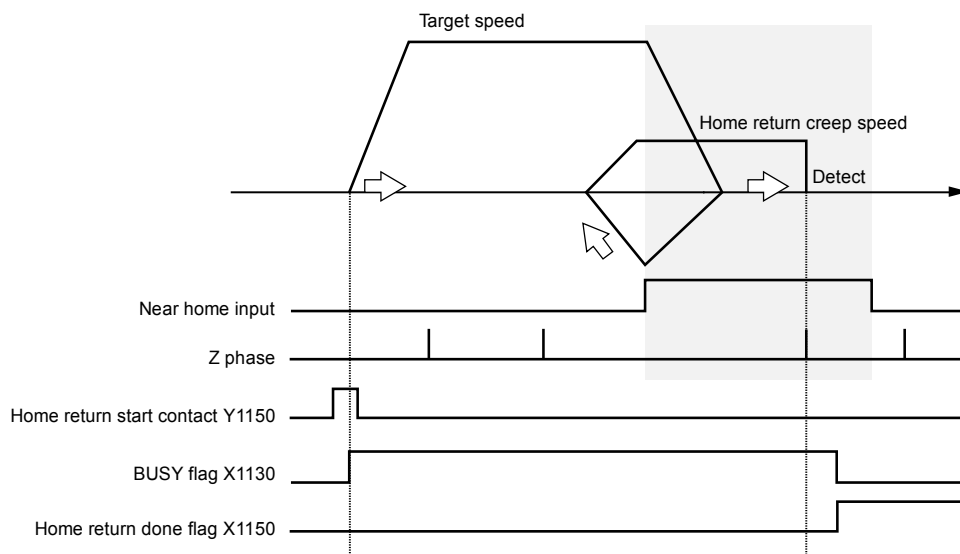

■ Operation of each contact

- The BUSY flag (X1130) indicating the state that a motor is running will turn ON when the home return of the positioning unit starts, and it will turn OFF when the operation completes.
- The home return done flag (X1150) indicating the state of operation completion will turn ON when the home return operation is completed, and it will be held until the next positioning control, JOG operation, home return, or pulser operation starts. The timing of that the flag turns ON is at the time that the home return operation is completed.

■ Sample program

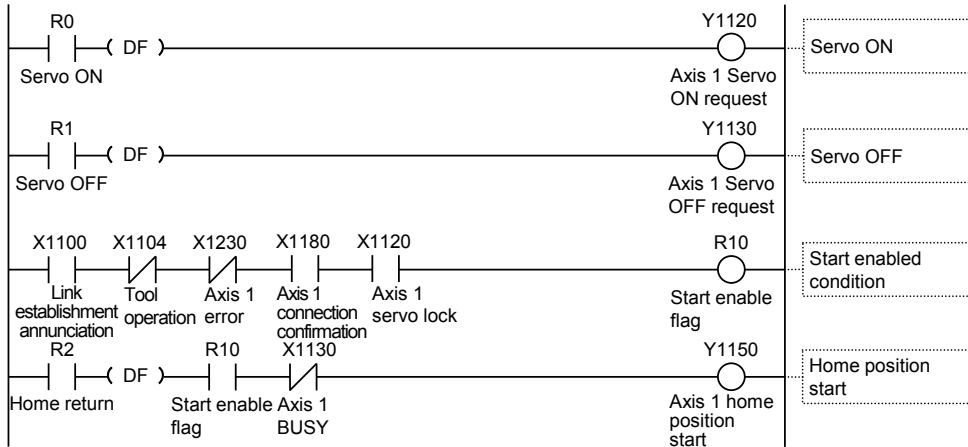

■ Programming precautions

- The starting point and flag number vary with the axis number.

■ Limit Input Operation

Condition	Direction	Limit status	Operation
When Home return operation is executed	Forward rotation	Limit input (+): ON	Executable
		Limit input (-): ON	Executable
	Reverse rotation	Limit input (+): ON	Executable
		Limit input (-): ON	Executable
During Home return operation	Forward rotation	Limit input (+): ON	Automatic reverse operation
	Reverse rotation	Limit input (-): ON	Automatic reverse operation

15

Pulse Input Function

15.1 Pulse Input

15.1.1 Pulse input application

Pulse inputs can be used for the following applications. The application is selected in the "Pulse input" setting dialog box of Configurator PM7.



■ Specifications

Item	Description
Number of channels	Max. 4 channels (Used in combination with the pulsar input and high-speed counter.)
Counting range	Counting range: -2,147,483,648 to 2,147,483,647 pulses
Input mode	Phase difference input, Direction detection input, Individual input (Multiplication function available for each.)

■ Pulse input application

Input object	Description
Pulsar	<ul style="list-style-type: none"> ● Set when using the manual pulsar. ● The pulsar of a specific axis can be specified with the pulsar operation setting code.
High-speed counter	<ul style="list-style-type: none"> ● Set when used for the general-purpose counter input. ● Various input methods (2-phase input, direction detection input, individual input). ● The unit stores the number of input pulses in the monitor area.

■ Combination restrictions based on application

Pulse input mode		Pulse input application	
		Pulsar	High-speed counter
Input mode	2-phase input	Available	Available
	Direction detection input	Not available	Available
	Individual input	Not available	Available
Multiplication	1 X	Not available	Available
	2 X	Not available	Available
	4 X	Available	Available (Note)

(Note): Only settable for 2-phase input.

15.1.2 Selection of Pulse Input Applications

The applications and methods of pulse input circuits are selected in the "Pulse input setting" dialog box of Configurator PM7.

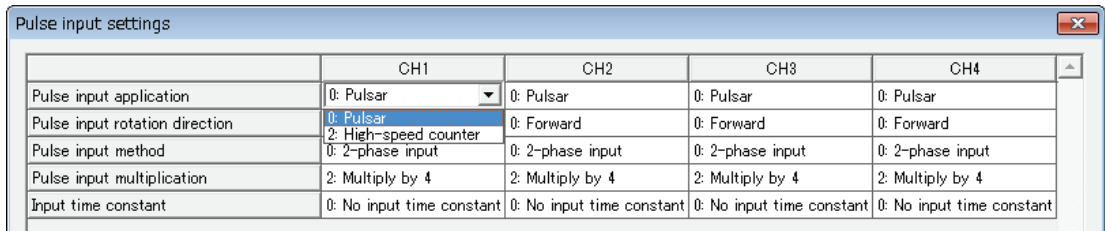

■ Setting item

Item	Default	Settable range
Pulse input application	0: Pulsar	0: Pulsar, 2: High-speed counter
Pulse input rotation direction	0: Forward	0: Forward, 1: Reverse
Pulse input method	0: 2-phase input	0: 2-phase input, 1: Direction detection input (Pulse/Sign), 2: Individual input (CW/CCW)
Pulse input multiplication	2: Multiply by 4	0: Multiply by 1, 1: Multiply by 2, 2: Multiply by 4
Input time constant	0: No input time constant	0: No input time constant, 1: 0.1us, 2: 0.5us, 3: 1.0us, 4: 2.0us, 5: 10.0us

15.1.3 Input mode of pulse input

- You can select from the following 3 modes depending on the input device to be connected.
- The counting operation changes according to the settings of multiplier as shown in the following page.

■ Input mode

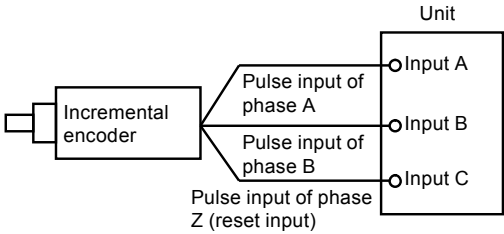
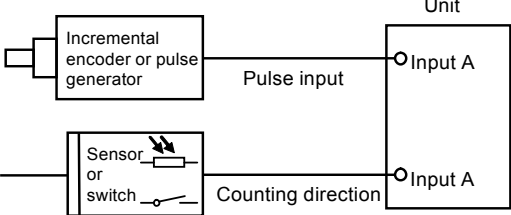
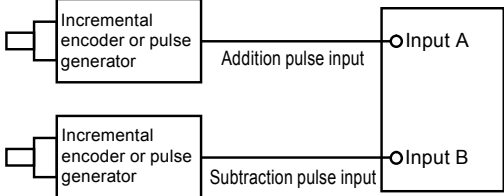
Mode	Connection	Counting
2-phase (phase difference)		<ul style="list-style-type: none"> • The 2-phase input connects the input A signal and input B signal of each counter to the input A signal and input B signal of corresponding encoder. • The counting direction depends on the phase difference between Phase A and Phase B. If Phase A leads over Phase B (electronic angle at 90°), add the counted value; and if Phase A lags behind Phase B (electronic angle at 90°), subtract the counted value.
Direction detection		<ul style="list-style-type: none"> • During direction detection input, counting signal is connected with input A signal. The counting direction is controlled by the level of the direction signal of input B signal. • If input B signal is turned OFF, the counter will perform addition operation when input A signal is on the rising edge or falling edge, and perform subtraction operation when input B is on the rising edge or falling edge.
Individual		<ul style="list-style-type: none"> • For individual input, the counter will perform addition operation when input A signal is on the rising edge or falling edge and subtraction operation when input B is on the rising edge or falling edge.

■ Counting operation of 2-phase input (phase difference input)

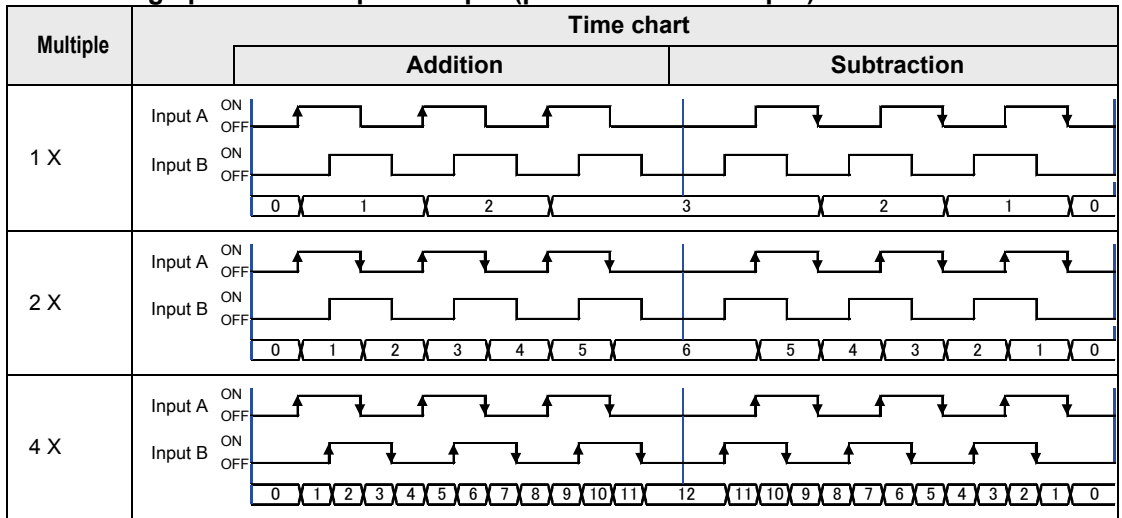

■ Counting operation for individual input

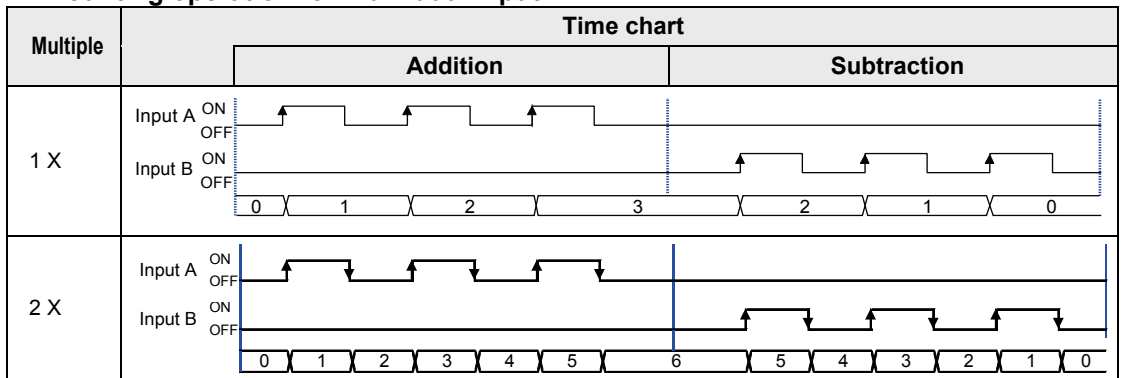

■ Counting operation for direction detection input

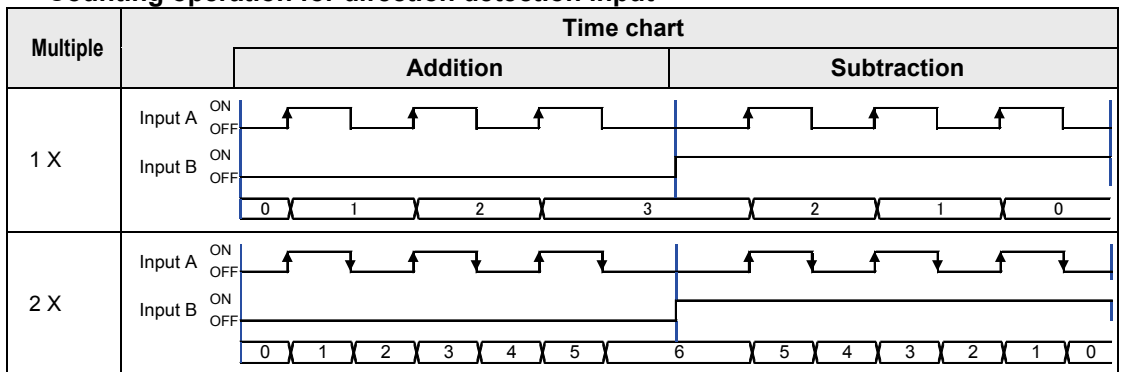

15.1.4 Monitoring of Pulse Input Values

- Pulse input values are saved in the positioning memory (Area no.0/Address H3C0-H3C7). Pulse input values can be read and monitored via user program.
- Save pulse input values corresponding to the purposes of pulse input (pulsar, and high-speed counter). (Unit: pulse)
- Accumulated save pulse input values and clear the pulse input values after the pulse input purposes are changed or the pulse input values are cleared.

■ **Sample program**

An example for monitoring the pulse input value of Axis-1 is given below.

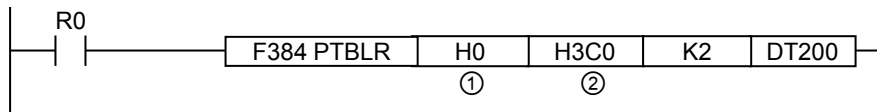

Symbols	Specified content of program	Specified value of program			
		CH1	CH2	CH3	CH4
①	Common area	H0			
②	Pulse input value area	H3C0	H3C2	H3C4	H3C6

15.1.5 Pulse Input Value Change Function

When the pulse input purpose is set to "high-speed counter", it is allowed to change the pulse input values saved in the positioning memory according to the user program.

■ **Pulse counting control area (positioning memory area no. 0)**

Offset Address (Hex)	Name	Description																					
H3A9	Request flag for pulse count change	<ul style="list-style-type: none"> • When the bit corresponding to each axis turns from 0 to 1, change the pulse input value to the preset pulse count change value. • This symbol is a pulse edge trigger. Please remember to turn 0 to 1 before the change. • After the change, the unit controller will automatically clear the corresponding bit. <table border="1" style="margin-left: 20px;"> <thead> <tr> <th>bit</th> <th>Name</th> <th>Initial value</th> <th>Description</th> </tr> </thead> <tbody> <tr> <td>0</td> <td>CH1 pulse count change</td> <td>0</td> <td rowspan="4">0: Pulse input value not changed 0→1: Pulse input value changed</td> </tr> <tr> <td>1</td> <td>CH2 pulse count change</td> <td>0</td> </tr> <tr> <td>2</td> <td>CH3 pulse count change</td> <td>0</td> </tr> <tr> <td>3</td> <td>CH4 pulse count change</td> <td>0</td> </tr> <tr> <td>15-4</td> <td>—</td> <td>—</td> <td>—</td> </tr> </tbody> </table>	bit	Name	Initial value	Description	0	CH1 pulse count change	0	0: Pulse input value not changed 0→1: Pulse input value changed	1	CH2 pulse count change	0	2	CH3 pulse count change	0	3	CH4 pulse count change	0	15-4	—	—	—
bit	Name	Initial value	Description																				
0	CH1 pulse count change	0	0: Pulse input value not changed 0→1: Pulse input value changed																				
1	CH2 pulse count change	0																					
2	CH3 pulse count change	0																					
3	CH4 pulse count change	0																					
15-4	—	—	—																				
H3B0- H3B1	Pulse input change value of CH1	Sets the pulse input value to be changed for CH1																					
H3B2- H3B3	Pulse input change value of CH2	Sets the pulse input value to be changed for CH2																					
H3B4- H3B5	Pulse input change value of CH3	Sets the pulse input value to be changed for CH3																					
H3B6- H3B7	Pulse input change value of CH4	Sets the pulse input value to be changed for CH4																					

■ Sample program

- An example for presetting the pulse input value of CH1 to any value K0 is given below. Read the pulse input value from the 1st line of the program for monitoring.
- Preset the pulse input value in corresponding positioning memory and set the change value request flag of corresponding channel. After the input value is changed, the change request flat area (positioning memory area no.0/address H3A9) will be cleared.

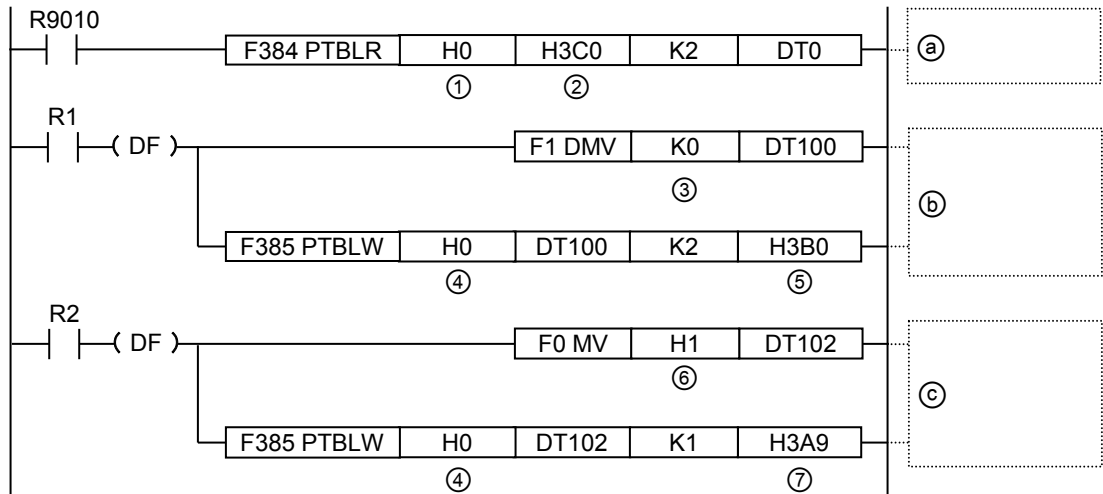

Symbols	Specified content of program	Specified value of program			
		CH1	CH2	CH3	CH4
①	Common area	H0			
②	Area in which pulse input values are stored	H3C0	H3C2	H3C4	H3C6
③	Change value	Any value			
④	Common area	H0			
⑤	Pulse count value change value area	H3B0	H3B2	H3B4	H3B6
⑥	Set value for the pulse count value change request flag area	H1	H2	H4	H8
⑦	Pulse count value change request flag area	H3A9			
(a)	Reading of pulse input value				
(b)	Write the preset values saved in the pulse input value area into the positioning memory				
(c)	Write the values to the positioning memory according to the request for pulse input change				

15.2 Setting and Operation of Pulsar

15.2.1 Overview

This function is used to connect axes by manual operation via the pulsars connected to the pulse input connectors of FP-XH M8N Control Unit.

- Pulsars for a maximum of 4 channels can be connected.
- The pulsar operation for a maximum of 8 axes can be performed. For each axis, a pulsar connected as an internal signal can be selected. Multiple channels can be activated simultaneously with one pulsar.

■ Pulsar input method

Operation mode	Operation
Standard operation	The operation to obtain the number of pulses of the pulsar in the unit of 1ms. The input content of the pulsar is directly reflected to the actual operation.
Speed restriction (pulse hold)	The input speed of the pulsar will be held at the preset max. speed if is to exceed the max. speed. Hold the number of pulses inputted by the pulsar. Because pulses that cannot be outputted will also be maintained, the pulses will still be outputted even if there's no input of the pulsar. The speed unit is "(the set unit X 1000)/s".
Speed restriction (time hold)	The input speed of the pulsar will be held at the preset max. speed if is to exceed the max. speed. Pulses that are cannot be outputted will be discarded, and the pulse output is interlocked with the operations of the pulsar. The speed unit is "(the set unit X 1000)/s".

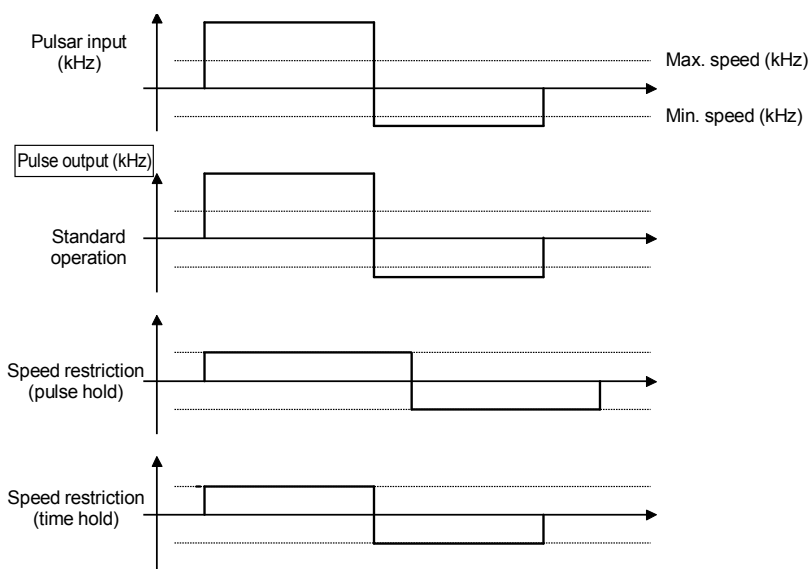

15.2.2 Settings for Pulsar Operation

For using the pulsar operation, set the parameters in the two dialog boxes "Pulse input" and "Parameter settings" of Configurator PM7.

■ Pulse input setting

Select "Pulsar" from the items of pulse input application.

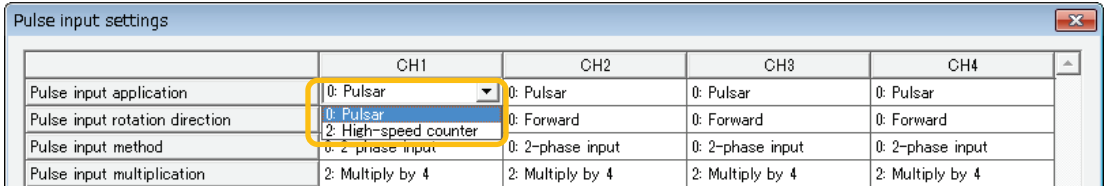

Item	Setting example	Settable range
Pulse input application	0: Pulsar	0: Pulsar
Pulse input rotation direction	0: Forward	0: Forward, 1: Reverse
Pulse input method	0: 2-phase input	When using the pulsar, only "0: 2-phase input" can be set.
Pulse input multiplication	2: Multiply by 4	When using the pulsar, only "2: Multiply by 4" can be set.

■ Parameter settings menu

- For the item of the "pulsar operation code" of the axis on which the pulsar operation is performed, select the channel number of the connected pulse input.
- The movement amount per an 1-pulse signal from the pulsar can be changed by setting the ratio numerator and ratio denominator for the input signal of the pulsar.

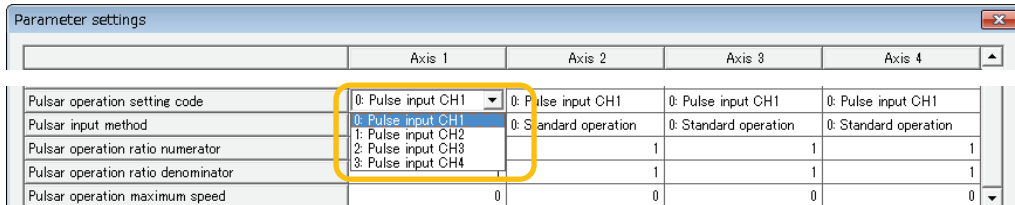

Item	Setting example	Settable range
Operation setting code	0: Pulse input CH1	0: Pulsar input CH1, 1: Pulsar input CH2, 2: Pulsar input CH3, 3: Pulsar input CH4
Pulsar operation ratio numerator	2	1-32,767
Pulsar operation ratio denominator	1	1-32,767
Pulsar input method	2: Speed restriction (time hold)	0: Standard operation , 1: Speed restriction (pulse hold), 2: Speed restriction (time hold)
Pulsar operation maximum speed	500	pulse: 0 -2,147,482,624 pps

15.2.3 Operation of Pulsar

The following example is explained with the pulsar operation of axis-1. Settings are made in pulses.

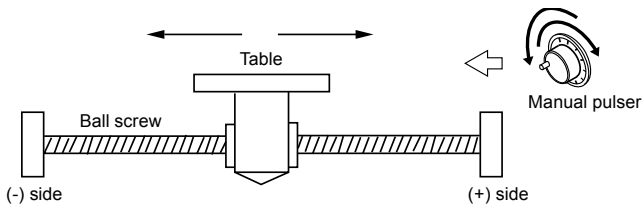

■ Operation diagram

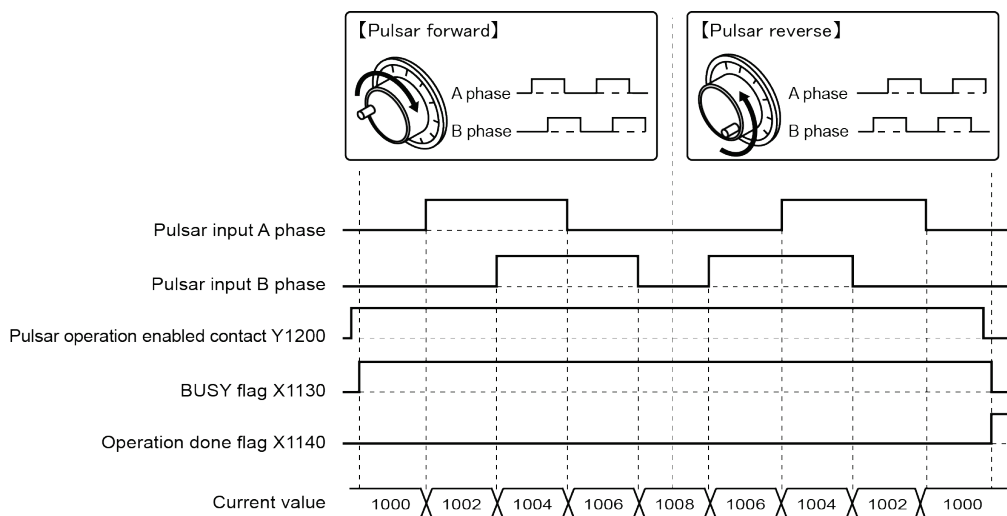

■ Operation of each contact

- The BUSY flag (X1130) indicating the state that a motor is running will turn ON when the pulser operation permit contact turns ON and will turn OFF when the contact turns OFF.
- The operation done flag (X1140) indicating the state of operation completion will turn ON when the pulser operation permit contact is turned OFF and the flag will be maintained until the next positioning control, JOG operation, home return, or pulser operation starts.

■ Sample program

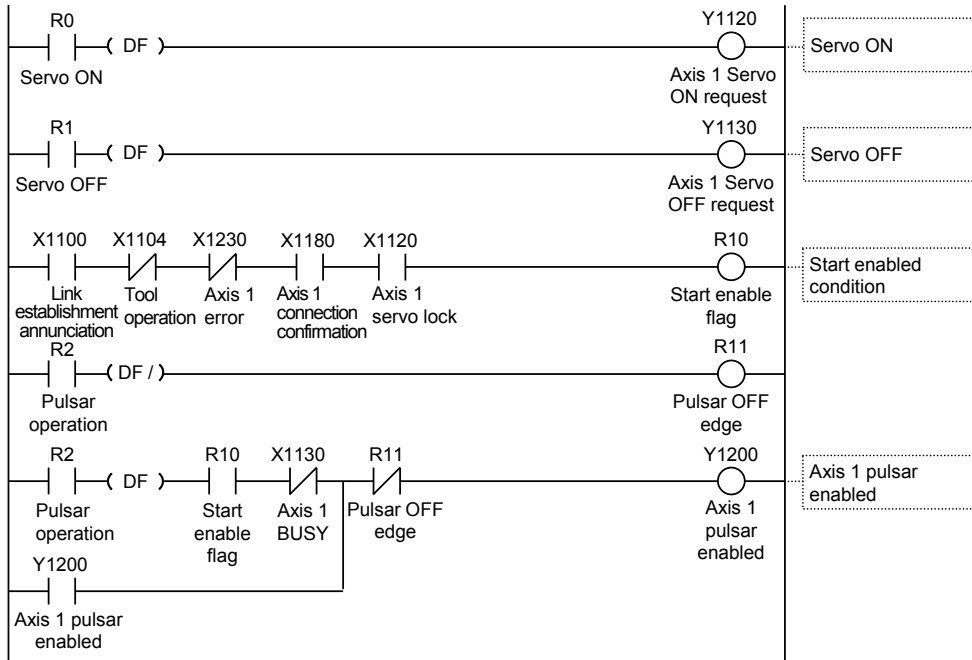

■ Programming precautions

- The starting point and flag number vary with the axis number.

■ Limit Input Operation

Condition	Direction	Limit status	Operation
When Pulsar operation is executed	Forward rotation	Limit input (+): ON	Not executable, Error occurs.
		Limit input (-): ON	Executable
	Reverse rotation	Limit input (+): ON	Executable
		Limit input (-): ON	Not executable, Error occurs.
During Pulsar operation	Forward rotation	Limit input (+): ON	Deceleration stop, Error occurs.
	Reverse rotation	Limit input (-): ON	Deceleration stop, Error occurs.

15.3 Pulse Input / High-speed Counter Function

15.3.1 Overview

The control unit can use the pulse inputs as external counters by setting the pulse input application to "High-speed counter".



◆ REFERENCE

- For the details of monitoring count values, refer to "15.1.4 Monitoring of Pulse Input Values".
- For the details of the methods to preset count values, refer to "15.1.5 Pulse Input Value Change Function".

15.3.2 Settings When Using High-speed Counter

For using the pulse input function as the high-speed counter, make the setting in the "pulse input" dialog box of Configurator PM7.

■ Pulse input setting

Select "High-speed counter" from the items of pulse input application.

	CH1	CH2	CH3	CH4
Pulse input application	0: Pulsar	0: Pulsar	0: Pulsar	0: Pulsar
Pulse input rotation direction	0: Pulsar 2: High-speed counter	0: Forward	0: Forward	0: Forward
Pulse input method	0: 2-phase input	0: 2-phase input	0: 2-phase input	0: 2-phase input
Pulse input multiplication	2: Multiply by 4	2: Multiply by 4	2: Multiply by 4	2: Multiply by 4
Input time constant	0: No input time constant	0: No input time constant	0: No input time constant	0: No input time constant

Item	Setting example	Settable range
Pulse input application	2: High-speed counter	2: High-speed counter
Pulse input rotation direction	0: Forward	0: Forward, 1: Reverse
Pulse input method	0: 2-phase input	0: 2-phase input, 1: Direction detection input (Pulse/Sign), 2: Individual input (CW/CCW)
Pulse input multiplication	2: Multiply by 4	0: Multiply by 1, 1: Multiply by 2, 2: Multiply by 4
Input time constant	0: No input time constant	0: No input time constant, 1: 0.1us, 2: 0.5us, 3: 1.0us, 4: 2.0us, 5: 10.0us



KEY POINTS

- For using the pulse input as the master axis of synchronous control, select an arbitrary pulse input channel from the "Select synchronous master axis" of the "Synchronous parameter settings" dialog box.

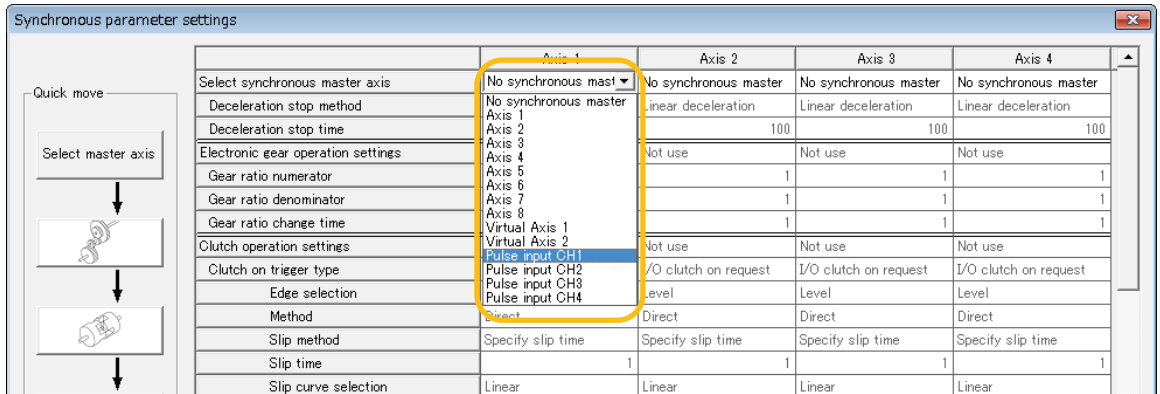

15.3.3 Count Disable/Enable Control

■ Control of pulse inputs

- When selecting "High-speed counter" for the pulse input application, the count of the pulse input value can be stopped arbitrarily. While the count of the pulse input value stoaps, the current pulse input value is held.
- The setting to disable/enable the count of pulse inputs is made by writing to the following area with user programs.

■ Program example

The following shows the example which disables the pulse input of the first axis when the execution condition R0 is ON.

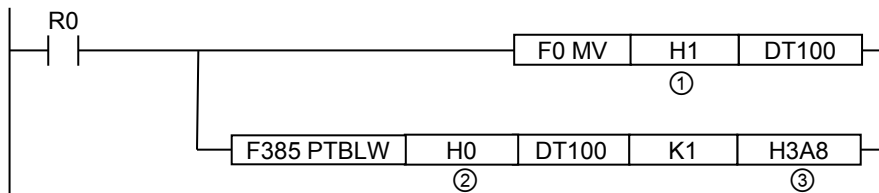

Code	Description	Value specified in program			
		CH1	CH2	CH3	CH4
①	Value corresponding to the axis that the count is disabled	H1 (bit0)	H2 (bit1)	H4 (bit2)	H8 (bit3)
②	Common area	H0			
③	Pulse count enable flag area	H3A8			

16



Stop Function

16.1 Types and Settings of Stop Function

16.1.1 Type of Stop Operations

- The following seven stop operations are available.
- The system stop, emergency stop, deceleration stop, and pause will be effective when allocated output signals turn ON by user programs.
- The limit stop, software limit stop, and error stop will be effective when corresponding conditions are established.

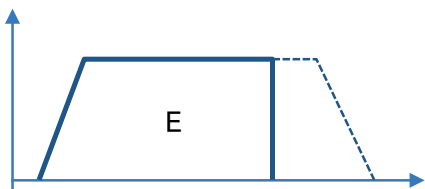
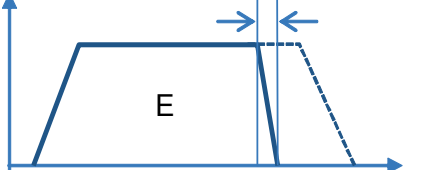
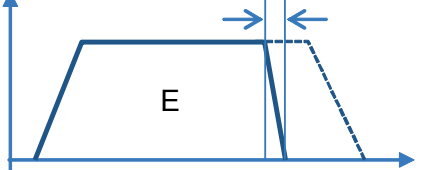
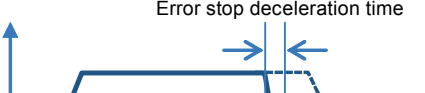
■ Type of operation stop

Name	Time chart	Occurrence Conditions and Operation
System stop		<ul style="list-style-type: none"> • When the system stop contact (Y1100) is set to ON, stop the operation of all axes immediately. • Stop at 1 ms deceleration time. • Perform the same action when the Operation pattern of the control unit is switched to PROG. from RUN.
Emergency stop		<ul style="list-style-type: none"> • When the system stop contacts (Y1180-Y1187) are set to ON, stop the started operation and the pulse output of the corresponding axis. • Set the deceleration time of emergency stop in the settings of the parameters in the Configurator PM7.
Limit stop		<ul style="list-style-type: none"> • When the limit+ input and limit-input (Y1200-Y120F) are set to ON, stop the operation of the corresponding axis. • Set the deceleration time of limit stop to be set in the settings of the parameters for deceleration.
Software limit stop		<ul style="list-style-type: none"> • When the software limit function is enabled, if the software limit range is exceeded, the operation that is already started will be stopped along with the operation of corresponding axis. • Performs a deceleration stop in the "error stop deceleration time" specified in the parameter settings menu of Configurator PM7
Error stop		<ul style="list-style-type: none"> • In case of self-diagnosis error (error code 44: position control operation error), the operation of corresponding axes (all axes or various axes) are stopped. (Note 1) • Performs a deceleration stop in the "error stop deceleration time" specified in the parameter settings menu of Configurator PM7.

(Note 1): Upon self-diagnosis error other than the position control operation error, the mode will change to PROG. and the system will be stopped. However, the mode when a self-diagnostic error occurs varies according to the settings of system registers.

Name	Real-time Charts	Occurrence Conditions and Operation
Deceleration stop (Note 1)		<ul style="list-style-type: none"> When the deceleration stop (Y1190-Y1197) is set to ON, stop the started operation and the operation of the corresponding axis. Set the deceleration time to be set in the starting position control operation for deceleration.
Pause (Note 1)		<ul style="list-style-type: none"> When the deceleration stop (Y1190-Y1197) is set to ON, stop the started operation and the operation of the corresponding axis. Set the deceleration time to be set in the starting position control operation for deceleration. When the deceleration stop signal is OFF, the stop control is executed again after cancellation of the deceleration stop.

(Note 1): The deceleration stop and pause function set the system operation setting area of the positioning memory and switch the operations with the user program.

■ I/O signal assignment

Signal name	I/O number							
	Axis 1	Axis 2	Axis 3	Axis 4	Axis 5	Axis 6	Axis 7 (virtual)	Axis 8 (virtual)
System stop	Y1100							
Emergency stop (The operation is the level type.)	Y1180	Y1181	Y1182	Y1183	Y1184	Y1185	Y1186	Y1187
Deceleration stop (The operation is the level type.)	Y1190	Y1191	Y1192	Y1193	Y1194	Y1195	Y1196	Y1197

(Note 1): During interpolation control, please turn the contact corresponding to the min. axis number in the interpolation group.

16.1.2 Stop Time Settings

Each stop time is specified for each axis on Configurator PM7.

■ Stop time settings

	Axis 1	Axis 2	Axis 3	Axis 4
Jog operation - Jog target speed	1000	1000	1000	1000
Emergency stop deceleration time (ms)	100	100	100	100
Limit stop deceleration time (ms)	100	100	100	100
Error stop deceleration time (ms)	100	100	100	100
J-point - Operation setting code	0: Linear acceleration/dec	0: Linear acceleration/dec	0: Linear acceleration/dec	0: Linear acceleration/dec

Item	Description
Emergency stop deceleration time	Set the deceleration time at the time of emergency stop. 0 to 10000ms (Default: 100 ms)
Limit stop deceleration time	Set the deceleration time at the time of limit stop and software limit stop. 0 to 10000ms (Default: 100 ms)
Error stop deceleration time	Set the deceleration time at the time of error stop. 0 to 10000ms (Default: 100 ms)

16.2 Operation During Stop

■ Operation during stop

- The system stop, emergency stop, deceleration stop and pause is performed by turning on each request contact in the I/O area.
- The stopped state is held while each contact is on until each request signal turns off. Any operation cannot be performed in the stopped state. It is also the same in the cases of limit stop, software limit stop and error stop.

■ Priority of stop operations

- When stop control requests are made simultaneously, the stop operations will be executed according to the following priority.

(1) System stop > (2) Error stop / Software limit stop / Limit stop > (3) Emergency stop > (4) Pause > (5) Deceleration stop

- The priorities of the error stop, software limit stop and limit stop are the same.
- In case of the same priorities, the axes will stop at the stop time previously occurred.

■ Dwell time setting

- The dwell time setting is invalid in the stop operations regardless of patterns.
- However, the dwell time setting is invalid in the positioning operation after a pause.

■ Flag processing

- In the case of system stop, the busy signal turns off and the operation done signal turns on.
- In the cases of emergency stop, limit stop, software limit stop, error stop and deceleration stop, the busy signal turns off and the operation done signal turns on after the completion of deceleration.

■ Current value coordinate

- Even in a stop operation, the current value coordinate area is always updated.
- After the emergency stop, limit stop, software limit stop, error stop, deceleration stop or pause, deceleration is performed with each specified deceleration time, and the value when the operation stops is stored.
- In the case of system stop, the value when the operation stops is stored.

16.3 Pause Function

16.3.1 Pause Function

- The pause function temporarily stops operation. Toggle between the pause function and the deceleration stop function for use.
- The pause function performs a deceleration stop in the deceleration time of operation when the deceleration stop request contact turns ON. After that, the stopped state is kept while the deceleration stop request contact (Y1190 to Y1197) is on, and the control stopped is restarted by turning off the deceleration stop request contact.



◆ KEY POINTS

- **No deceleration stop can be executed while the pause function is in use. Use the emergency stop function in the case of executing a stop while the pause function is in use.**
- **The pause function is enabled only when the positioning unit is in automatic operation (positioning control). During a manual operation (JOG operation/home return/pulsar operation), it is the same operation as a deceleration stop.**
- **Like other stop functions, the pause function will maintain the stop state while the deceleration stop (pause) request signal is ON. The pause will be canceled if an emergency stop or system stop is executed while the positioning unit is not operating, and the positioning unit will go into the emergency stop or system stop state.**

16.3.2 Pause Settings

- Deceleration stop and pause set the system operation setting area of the positioning memory (positioning memory area no.0/Address H389) and switch the operations with the user program.

■ System operation setting area (positioning memory area no.3)

Offset Address (Hex)	Name	Initial value	Description
Common area H389	Deceleration stop operation	0	Operate when the deceleration stop request signal is Active (OFF⇒ON).
			0: Deceleration stop During repetition, the operation stops to the E-point of the object of repetition.
			1: Pause <ul style="list-style-type: none"> ● Perform deceleration stop, and resume position control when the "deceleration stop request signal" is canceled (ON⇒OFF). ● All operations are the same to that of deceleration stop for cases other than position control operation. ● During repetition, the operation stops till the E-point of the object of repetition, and resumes when the "deceleration stop request signal" is canceled (ON⇒OFF). ● If system stop or emergency stop is executed during pause, the pause will be canceled and the operation will not be resumed even if the "deceleration stop request signal" is canceled (ON⇒OFF).

■ **Sample program**

- Operation when the deceleration stop contact of axis-1 is turned ON.
- Set parameters corresponding to the operation in the system operation area (positioning memory area no.0/Address H389).

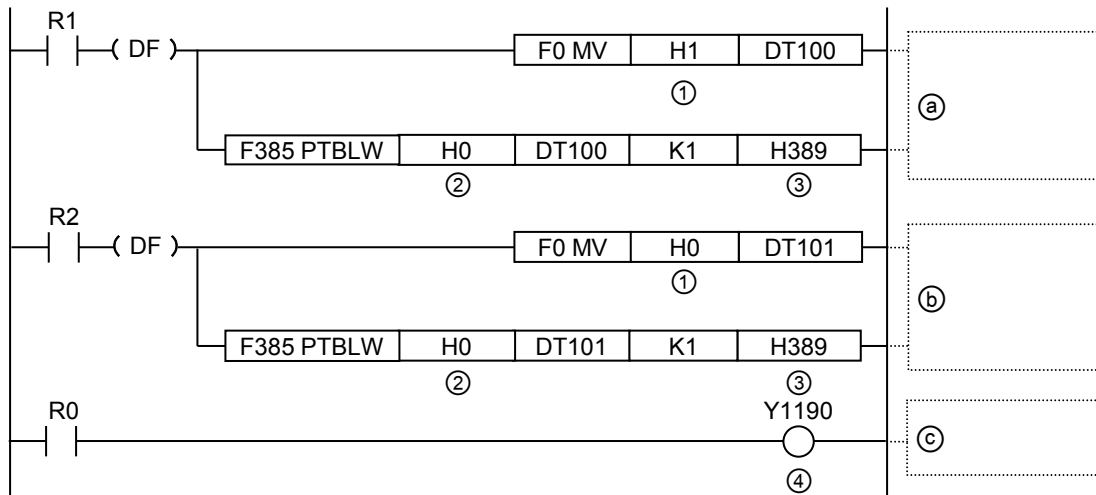

Code	Description	Value specified in program							
		Axis 1	Axis 2	Axis 3	Axis 4	Axis 5	Axis 6	Axis 7 (virtual)	Axis 8 (virtual)
①	Parameter values for switching operations	H0: Deceleration stop operation, H1: Pause operation							
②	Common area	H0							
③	System stop	H389							
④	Deceleration stop (The operation is the level type.)	Y1190	Y1191	Y1192	Y1193	Y1194	Y1195	Y1196	Y1197
(a)	Switch the operation to pause when the deceleration stop contact turns ON								
(b)	Switch the operation to deceleration stop when the deceleration stop contact turns ON								
(c)	Perform deceleration stop or pause								

17

Auxiliary Function

17.1 Dwell Time

The time taken until the next operation after the completion of an executed positioning table in the automatic operation is called dwell time.

■ Operation pattern and dwell time

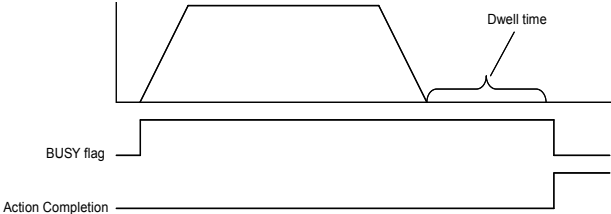
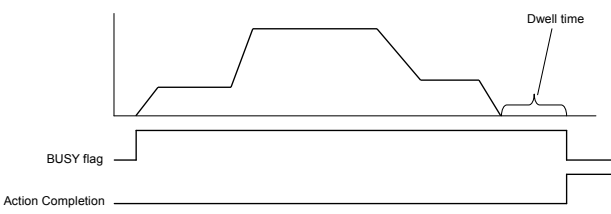
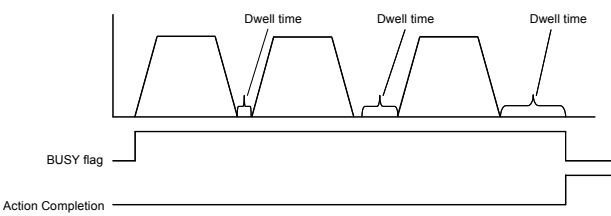
Operation pattern	Dwell time and operation	
E-point control		<p>The dwell time is the time taken from the completion of the position reference until the operation done flag turns ON.</p>
P-point control		<p>While the positioning unit is in P-point control, the positioning table will operate consecutively, and the dwell time will be invalid. For the last table (E point), like E-point control, dwell time is a period required from the completion of the position reference until the operation done flag turns ON.</p>
C-point control		<p>The dwell time is the waiting time for executing the next table from the completion of the positioning table (deceleration stop). For the last table (E point), like E-point control, dwell time is a period required from the completion of the position reference until the operation done flag turns ON.</p>

■ Setting of the dwell time

- The dwell time is designated in the position control data tables via the Configurator PM7
- It is allowed to set each data table of position control data within the range of 0-32767 (ms).

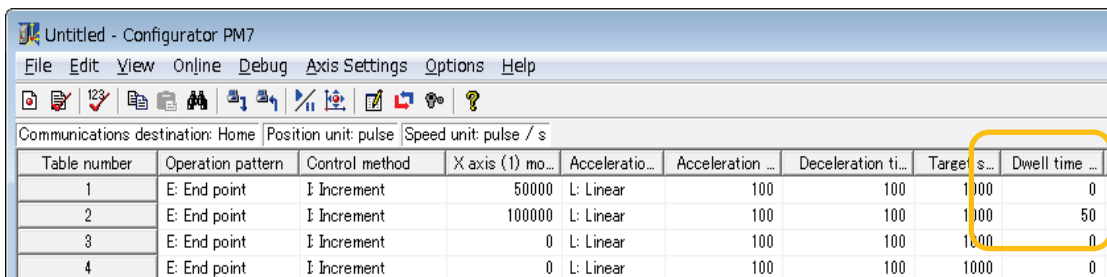

Table number	Operation pattern	Control method	X axis (1) mo...	Acceleratio...	Acceleration ...	Deceleration ti...	Target s...	Dwell time ...
1	E: End point	I Increment	50000	L: Linear	100	100	1000	0
2	E: End point	I Increment	100000	L: Linear	100	100	1000	50
3	E: End point	I Increment	0	L: Linear	100	100	1000	0
4	E: End point	I Increment	0	L: Linear	100	100	1000	0

17.2 Software Limit

■ Software limit functions

The system is designed to mechanically set the limit (+) and limit (-) to restrict the moving range of a motor.

Separately from the mechanical limits (+) and (-), the software limit is a function to add the limits for the absolute coordinate managed within the positioning unit. As the software limit is a function for the protection of the motor, servo amplifier and motor driver, it is recommended to set them to the values within the range of the mechanical limits (+) and (-) as below.

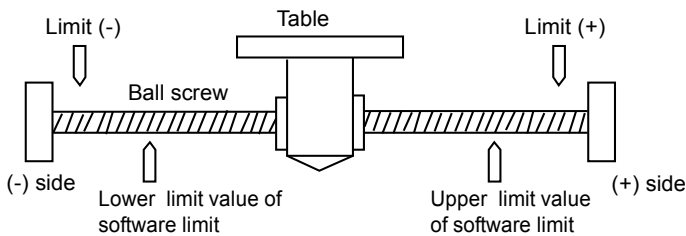

If the operating range of the motor exceeds the setting range of the software limit (upper and lower limit values), an error will occur, and the deceleration stop will be executed. It is necessary to clear the error and move the motor into the range of the software limit using an operation such as JOG operation after the stop.

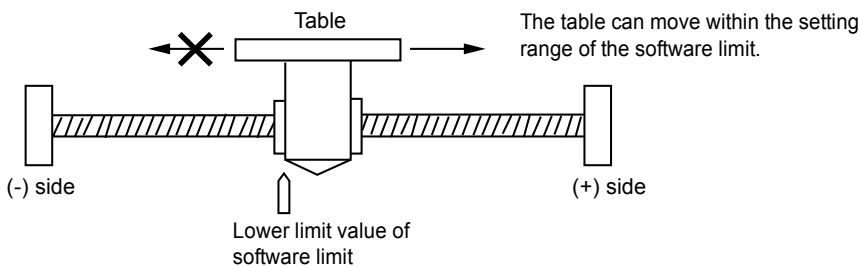

■ Software limit settings

- Software limit can be enabled/disabled in the Parameter Settings dialog box of Configurator PM7 by axis.
- Software limit can be enabled/disabled separately for position control, home return and JOG operation. For example, you can enable software limit during home return and JOG operation

Parameter settings	Axis 1	Axis 2	Axis 3	Axis 4
Software limit (Positioning control)	A: Enabled	N: Disabled	N: Disabled	N: Disabled
Software limit (Home return)	N: Disabled	N: Disabled	N: Disabled	N: Disabled
Software limit (JOG operation)	N: Disabled	N: Disabled	N: Disabled	N: Disabled
Software limit upper limit value	1073741823	1073741823	1073741823	1073741823
Software limit lower limit value	-1073741823	-1073741823	-1073741823	-1073741823
Auxiliary output mode	N: Not used	N: Not used	N: Not used	N: Not used

17.3 Auxiliary Output

17.3.1 Auxiliary Output Function

- Auxiliary output is the function to notify the outside of which data is being executed during automatic operation (E-point control, C-point control, P-point control and J-point control).
- Auxiliary output contacts and auxiliary output codes vary depending on data tables in execution.
- Values of auxiliary output codes can be held to the next position control data table for execution. In addition, upon completion of auto operation, the auxiliary output codes just outputted will be held.

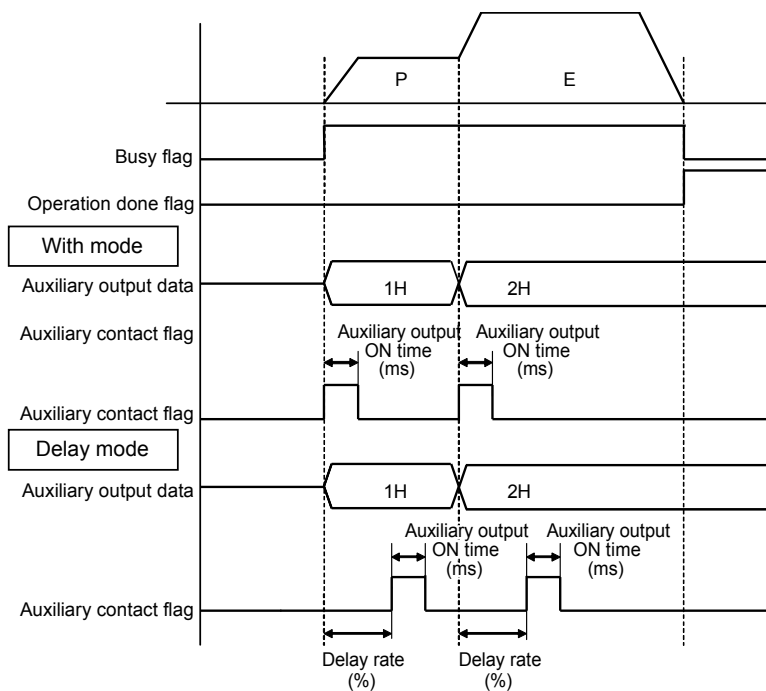

- Auxiliary output modes include the With mode and the Delay mode. Auxiliary output mode, auxiliary output ON time and delay ratio can be set via the Configurator PM7.
- Auxiliary output contacts can be monitored by input contacts (X1190-X1197) assigned to various axes.
- Auxiliary output codes can be set for various position control data tables via the Configurator PM7. Auxiliary output codes can read positioning memory (information area of each axis) for monitoring.

17.3.2 Auxiliary Output Settings

Auxiliary output is designated with the Configurator PM7 by axis. The Auxiliary output function is valid when the auxiliary output mode is selected from the "Parameter Settings" dialog box.

■ Settings of auxiliary output mode/auxiliary output contact operation

	Axis 1	Axis 2	Axis 3	Axis 4
Auxiliary output mode	D: Delay mode	W: With mode	N: Not used	N: Not used
Auxiliary output on time (ms)	10	10	10	10
Auxiliary output delay ratio (%)	50	0	0	0
Completion width (pulse)	10	10	10	10
Monitor error - Torque judgment	N: Disabled	N: Disabled	N: Disabled	N: Disabled

Item	Description	
Auxiliary output mode	N: Unused	Selected when auxiliary output contacts and auxiliary output codes are not used.
	W: With mode	As the auto operation started, the auxiliary contact flag assigned to corresponding axis in the I/O area is turned ON.
	D: Delay mode	According to the position control movement ratio (%) of auto operation, the auxiliary contact flag assigned to corresponding axis in the I/O area is turned ON. However, when the auto operation is set to J-point control, the operation is the same to that in the With mode.
Auxiliary output ON time	Sets the auxiliary output contact ON time. 0-255 ms (Initial value at 10 ms)	
Auxiliary output Delay ratio	sets the ratio of the delay to the auxiliary output contact is turned ON when the auxiliary output mode is set to Delay mode. Setting range 0-100% (initial value: 0%)	

■ Settings of auxiliary output codes

Each data table of position control data can be assigned an output code (1 byte).

Table number	Operation pattern	Control method	X axis (1)...	Accelerati...	Accele...	Deceleration...	Target s...	Dwell time	Auxiliary...
1	E: End point	I Increment	50000	L: Linear	100	100	1000		1
2	E: End point	I Increment	100000	L: Linear	100	100	1000		2
3	E: End point	I Increment	0	L: Linear	100	100	1000		0
4	E: End point	I Increment	0	L: Linear	100	100	1000		0



◆ KEY POINTS

- If only auxiliary output code is used, please select any auxiliary output mode from the With mode and the Delay mode.
- No matter in which auxiliary output mode (With mode or Delay mode), the auxiliary output codes will be saved at the beginning of position control.

17.3.3 Monitoring of Auxiliary Output

Auxiliary output contacts in operation can be monitored by input contacts. In addition, auxiliary output codes can read positioning memory area for monitoring.

■ **Assignment of auxiliary output contacts**

Item	Axis 1	Axis 2	Axis 3	Axis 4	Axis 5	Axis 6	Axis 7 (virtual)	Axis 8 (virtual)
Auxiliary output contact	X1190	X1191	X1192	X1193	X1194	X1195	X1196	X1197

■ **Auxiliary output code monitoring**

- Auxiliary output codes indicating the current status are saved at address H39 of the information area of each axis in the positioning memory. Please read them with the user program.
- Auxiliary output codes can also be monitored with the data monitoring of the Configurator PM7

■ **Sample program**

An example of reading auxiliary output codes of axis-1 and axis-2 to DT0-DT1 is given below.

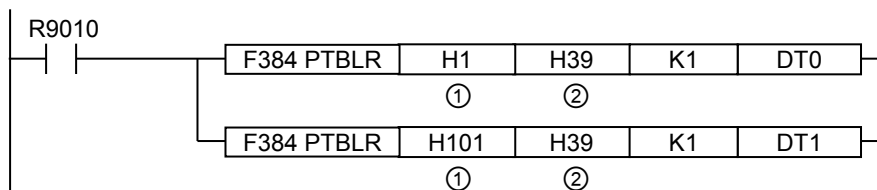

Code	Content specified by program	Value specified by program							
		Axis 1	Axis 2	Axis 3	Axis 4	Axis 5	Axis 6	Axis 7 (virtual)	Axis 8 (virtual)
①	Axis no. and each information area	H1	H101	H201	H301	H401	H501	H601	H701
②	Area in which auxiliary output codes are stored	H39							

17.3.4 Operation upon Movement Change during Operation

■ **Precautions for movement change during position control operation**

When the Delay ratio is set to 1-99%, the operation of the auxiliary contacts during movement change in position control operation is shown as follows.

- When executing movement change request before the auxiliary contact is turned ON, please turn the auxiliary contact on according to the ratio before the movement change.
- The data table is turned ON upon completion of data table execution when the movement when the auxiliary contact is turned on is smaller than the target value after change.

17.4 Coordinate Origin

The coordinate origin function is used to set the coordinates of the origin to any value after home return.

- The coordinates of the origin after home return can be set in the positioning memory via the Parameter Setting dialog box of Configurator PM7 or the user program.
- The set coordinates will be turned into the coordinate origin when executing home return of the target axis.

■ Settings of coordinate origin

The coordinate origin for each axis can be set in the Parameter Settings dialog box of Configurator PM7.

	Axis 1	Axis 2	Axis 3	Axis 4
Home return - Return setting code	0: Dog method 1	0: Dog method 1	0: Dog method 1	0: Dog method 1
Home return - Stop-on-contact torque value (%)	100	100	100	100
Home return - Stop-on-contact judgment time (ms)	100	100	100	100
Home return - Return direction	0: Limit (-) direction	0: Limit (-) direction	0: Limit (-) direction	0: Limit (-) direction
Home return - Return acceleration time (ms)	100	100	100	100
Home return - Return deceleration time (ms)	100	100	100	100
Home return - Return target speed	1000	1000	1000	1000
Home return - Return creep speed	100	100	100	100
Home return - Home coordinates	100000	0	0	0
Jog operation - Acceleration/deceleration method	0: Linear acceleration/dec	0: Linear acceleration/dec	0: Linear acceleration/dec	0: Linear acceleration/dec

■ Sample program

An example of reading the current value of axis-1 after unit system conversion and setting it the coordinate origin is given below.

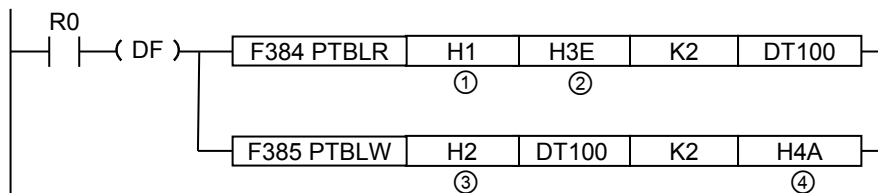

Code	Description	Value specified in program							
		Axis 1	Axis 2	Axis 3	Axis 4	Axis 5	Axis 6	Axis 7 (virtual)	Axis 8 (virtual)
①	Axis no. and each information area	H1	H101	H201	H301	H401	H501	H601	H701
②	Memory area for unit conversion current value	H3E							
③	Axis no. and each axis setting area	H2	H102	H202	H302	H402	H502	H602	H702
④	Coordinate origin setting area	H4A							



◆ **KEY POINTS**

- The coordinate origin will be set to be equal to the integral value after unit system conversion.
E.g.) when the unit is μm (0.1 μm), 1,000.0 μm is set as "10000".

17.5 Current Value Update

The current value update function is used to set the "current value after conversion of unit system" saved in the positioning memory to any value.

- Set the value as the current value via the user program in the current value update coordinates area (positioning memory area no.0/Address HC8-HD7) of the positioning memory.
- When the bit of the target axis of the current value update question flag area (positioning memory area no.0/Address HC0) is set to ON, the "current value after conversion of unit system" of the information area of each axis (positioning memory area no.1/Address H3E-H3F) will be changed to the designated current value.

■ Sample program

An example of presetting any value K100000 in the positioning memory area to update the current value after conversion of unit system of axis-1 is given below. In the first line of the program, read the current value after conversion of unit system of axis-1 to the data registers DT0-DT1 for monitoring.

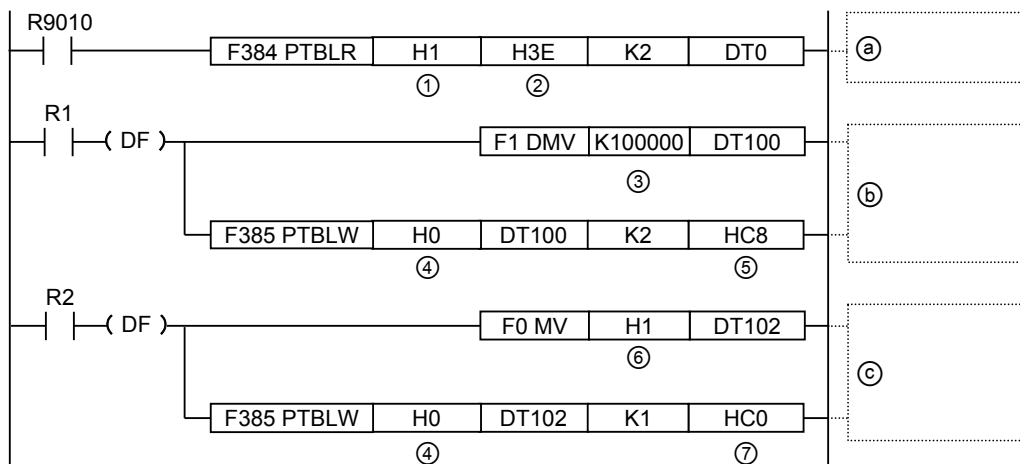

■ Code	Content specified by program	Value specified by program							
		Axis 1	Axis 2	Axis 3	Axis 4	Axis 5	Axis 6	Axis 7 (virtual)	Axis 8 (virtual)
①	Axis no. and each information area	H1	H101	H201	H301	H401	H501	H601	H701
②	Memory area for unit conversion current values	H3E							
③	Update value	Arbitrary value							
④	Common area	H0							
⑤	Current value update coordinate area	HC8	HCA	HCC	HCE	HD0	HD2	HD4	HD6
⑥	Set value of current value update request flag area	H1	H2	H4	H8	H10	H20	H40	H80
⑦	Current value update request flag area	HC0							

■ **Current value update area (positioning memory: common area)**

Memory address (Hex)	Name	Description																																	
HC0	Current value update request flag	<p>Change the current value coordinates after conversion of unit system managed by the unit controller (offset addresses H3E-H3F of the axes) into the values set in the current value updated coordinates areas (HC8-HD7) only when the bit corresponding to the axes turns from 0 to 1.</p> <p>Upon completion of the change, the unit controller will automatically clear the corresponding bit of the current value update request flag area (HC0).</p> <table border="1"> <thead> <tr> <th>bit</th> <th>Name</th> <th>Initial value</th> <th>Description</th> </tr> </thead> <tbody> <tr> <td>0</td> <td>Current value update request of axis 1</td> <td>0</td> <td rowspan="9"> 0: unchanged 1: Coordinate origin of corresponding content changed (Auto clearing by the unit controller after execution) </td> </tr> <tr> <td>1</td> <td>Current value update request of axis 2</td> <td>0</td> </tr> <tr> <td>2</td> <td>Current value update request of axis 3</td> <td>0</td> </tr> <tr> <td>3</td> <td>Current value update request of axis 4</td> <td>0</td> </tr> <tr> <td>4</td> <td>Current value update request of axis 5</td> <td>0</td> </tr> <tr> <td>5</td> <td>Current value update request of axis 6</td> <td>0</td> </tr> <tr> <td>6</td> <td>Current value update request of (virtual) axis 7</td> <td>0</td> </tr> <tr> <td>7</td> <td>Current value update request of (virtual) axis 8</td> <td>0</td> </tr> <tr> <td>15-8</td> <td>—</td> <td>—</td> <td>—</td> </tr> </tbody> </table>	bit	Name	Initial value	Description	0	Current value update request of axis 1	0	0: unchanged 1: Coordinate origin of corresponding content changed (Auto clearing by the unit controller after execution)	1	Current value update request of axis 2	0	2	Current value update request of axis 3	0	3	Current value update request of axis 4	0	4	Current value update request of axis 5	0	5	Current value update request of axis 6	0	6	Current value update request of (virtual) axis 7	0	7	Current value update request of (virtual) axis 8	0	15-8	—	—	—
		bit	Name	Initial value	Description																														
		0	Current value update request of axis 1	0	0: unchanged 1: Coordinate origin of corresponding content changed (Auto clearing by the unit controller after execution)																														
		1	Current value update request of axis 2	0																															
		2	Current value update request of axis 3	0																															
		3	Current value update request of axis 4	0																															
		4	Current value update request of axis 5	0																															
		5	Current value update request of axis 6	0																															
		6	Current value update request of (virtual) axis 7	0																															
		7	Current value update request of (virtual) axis 8	0																															
15-8	—	—	—																																
HC8-HC9	Current value update coordinate of axis 1	Saves the preset coordinates as the current value.																																	
HCA-HCB	Current value update coordinate of axis 2																																		
HCC-HCD	Current value update coordinate of axis 3																																		
HCE-HCF	Current value update coordinate of axis 4																																		
HD0- HD1	Current value update coordinate of axis 5																																		
HD2- HD3	Current value update coordinate of axis 6																																		
HD4- HD5	Current value update coordinate of (virtual) axis 7																																		
HD6-HD7	Current value update coordinate of (virtual) axis 8																																		

(Note): The current value update request flag is designated via the H constant. For update request of axis-1 and axis-2, write H3.



◆ **KEY POINTS**

- **The current value changed via current value update is the current value after conversion of unit system.**

17.6 Target Speed Change Function

17.6.1 Overview

The target speed change function is used to change the target speed to any speed according to the position control data tables in operation. The operation amount in the data table will not be changed even if the speed is changed.

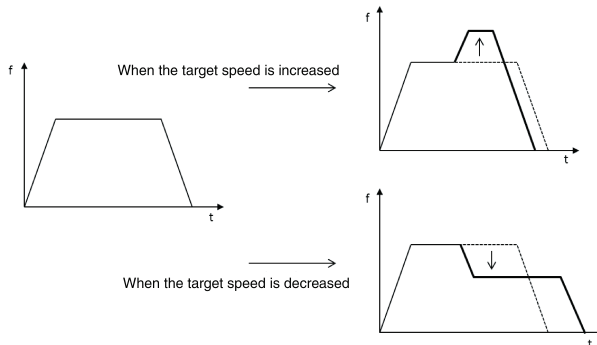

■ Use Conditions

The use conditions of the target speed change function are as follows.

A: Available, N/A: Not available

Position control	Control method	Separate axis control	A	<ul style="list-style-type: none"> In the case of the synchronous control, the speed can be changed only for the master axis. (Slave axes operate according to the master axis.)
		Interpolation control	N/A	
		Synchronous control	A	
	Operation pattern	E-point	A	<ul style="list-style-type: none"> The speed can be changed more than once in one table.
		P-point	A	<ul style="list-style-type: none"> The speed cannot be changed during the deceleration in accordance with the stop operation.
C-point		A	<ul style="list-style-type: none"> The speed cannot be changed during the deceleration in the C point control. 	
Repetition control		A	<ul style="list-style-type: none"> The speed cannot be changed during the dwell time in the C point control. For the J point control, use "J point speed change contact" to change the speed. 	
JOG operation		N/A	<ul style="list-style-type: none"> For the JOG operation, change "JOG operation target speed" directly to change the speed. 	
Home return		N/A		

■ Speed change mode

Speed direct specification	<p>This is a method in which a desired speed is specified directly and the change is requested by I/O.</p> <p>The valid range of the function can be selected from two patterns, which are "Active table only" and "Active table to completion of operation".</p>
Ratio specification (Override)	<p>This is a function to change a set speed using a specified ratio (%).</p> <p>The change request by I/O is not necessary, and the change is reflected when the set value (ratio) is changed.</p> <p>The function is valid for all the positioning operations after the set timing.</p> <p>The ratio specification also becomes valid when the speed is changed by the speed direct specification.</p>

17.6.2 Setting Procedures and Operations (Speed Direct Specification Method)

■ Setting procedures and operations of speed direct specification method

The target speed change function in the speed direct specification method is activated by the following procedure during a positioning operation.

1. Set "Change mode selection" and "Change speed" in the positioning memory.
2. Turn on the "Speed change request" contact during a positioning operation.

* "Speed change done annunciation" turns ON when the speed change is actually started.

* Once the "Speed change request" contact turns OFF, the "Speed change done annunciation" also turns OFF.

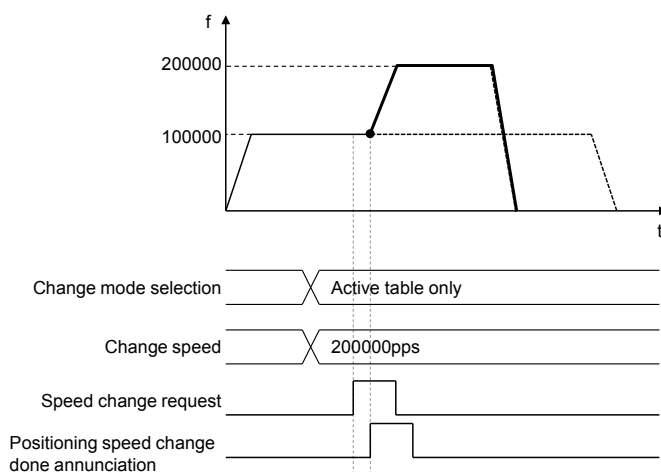

(Note 1) The acceleration time to the change speed and the deceleration time from the change speed follows the setting values of the active table.

(Note 2) The movement amount does not change when the speed change is performed.

■ Setting parameters of speed direct specification method

The following parameters are used in the target speed change function of the speed direction specification method.

Positioning operation change setting area (positioning memory area no. 5)

Offset address (Hex)	Name	Default	Description
H1	Positioning speed change Change mode selection	H0	Area for setting the range of the positioning speed change. 0000H: Active table only 0001H: Active table to E point table (until the completion of the operation) In the case of other values, the unit operates as the setting of 0000H (Active table only).
H2-H3	Positioning speed change Change speed	K100	Area for setting a change speed for changing the positioning speed. Set using unit system conversion values. 1-2,147,482,624 (designated unit system)

■ Example of operation (1) Speed direct specification, Active table only

Parameter	Setting value
Change mode selection	0000H (Active table only)
Change speed	150,000 (pps)

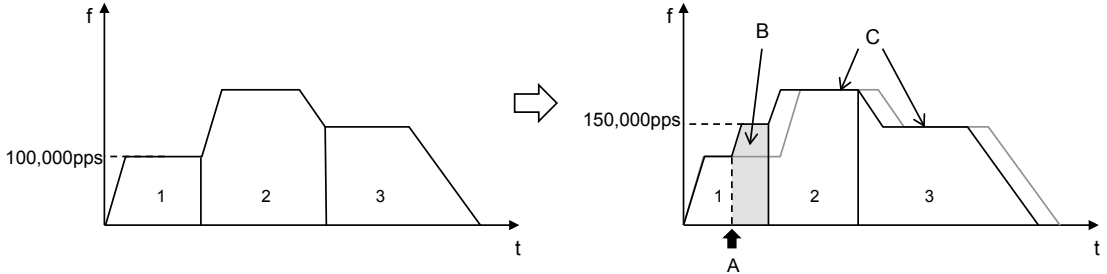

A	Speed change request contact turns ON.
B	Only the speed of the table 1 is changed to 150,000 pps.
C	The speeds of the table 2 and 3 do not change.

■ Example of operation (2) Speed direct specification, Active table to E point table (until the completion of the operation)

Parameter	Setting value
Change mode selection	0001H (Active table to E point table)
Change speed	150,000 (pps)

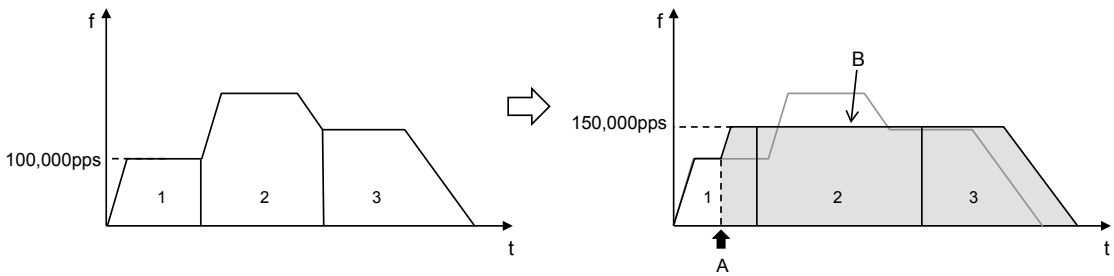

A	Speed change request contact turns ON.
B	The speeds of all consecutive tables are changed to 150,000 pps.

■ **Example of operation (For repetitive operations)**

When the speed change (speed direct specification, active table only) is performed during the positioning repeat operation, only the speed of the active table in an active repeat period is changed.

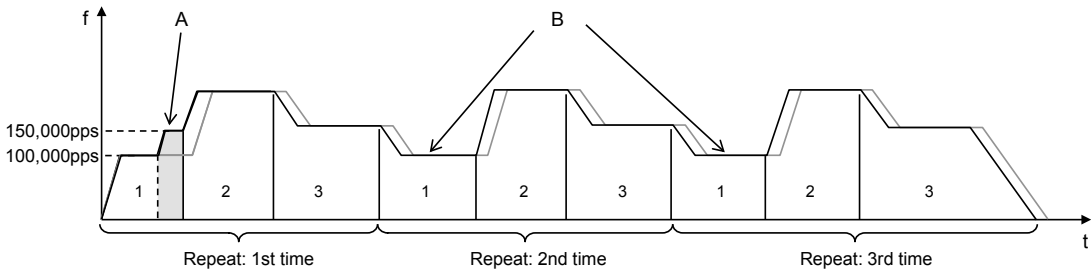
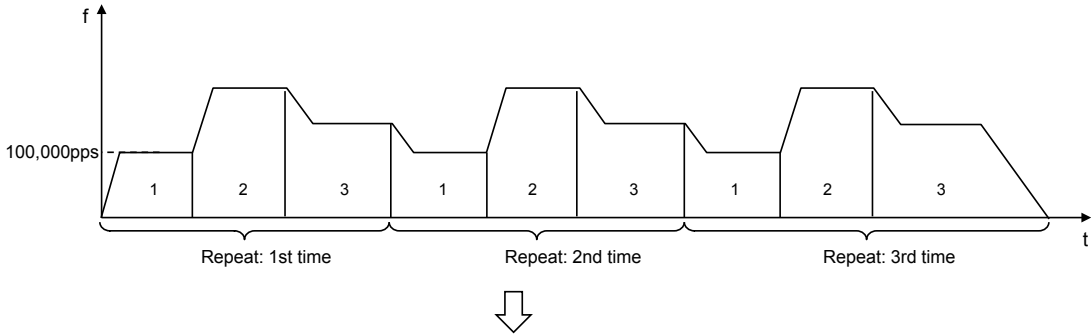

A	Only the speed of the table 1 in the first repeat period is changed to 150,000 pps.
B	The speeds of the table 1 in the second and third repeat periods are not changed.

17.6.3 Setting Procedures and Operations (Ratio Specification Method)

■ Setting procedures and operations of ratio specification method (Override)

When setting the ratio specification, the command speed is immediately reflected in the specified ratio once the "Ratio specification" in the shared memory is changed.

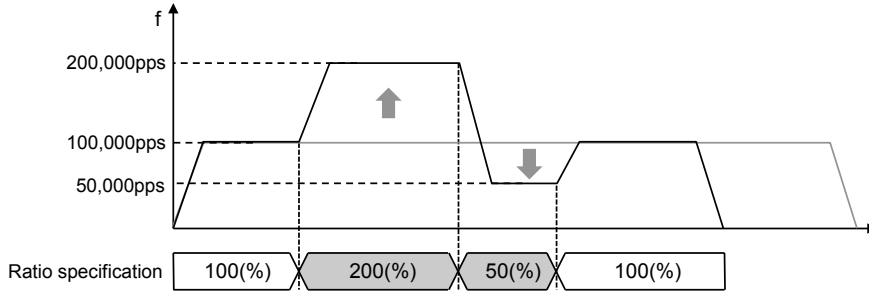

(Note 1) The acceleration time to the change speed and the deceleration time from the change speed follows the setting values of the active table.

(Note 2) The movement amount does not change when the speed change is performed.

■ Setting parameters of ratio specification method

The following parameters are used in the target speed change function of the ratio specification method.

Positioning operation change setting area (Positioning memory area No. 5)

Offset address (Hex)	Name	Default	Description
H0	Positioning speed change Ratio specification (Override)	K100	Area for setting the change ratio (override) to the command speed for the positioning speed change. The speed change request by I/O is not necessary, and the change becomes valid when the set value (ratio) is set. 1 to 300 (%)

■ Example of Operation

When changing the ratio from 100% to 150%

Parameter	Setting value
Ratio specification	100 (%) to 150 (%)

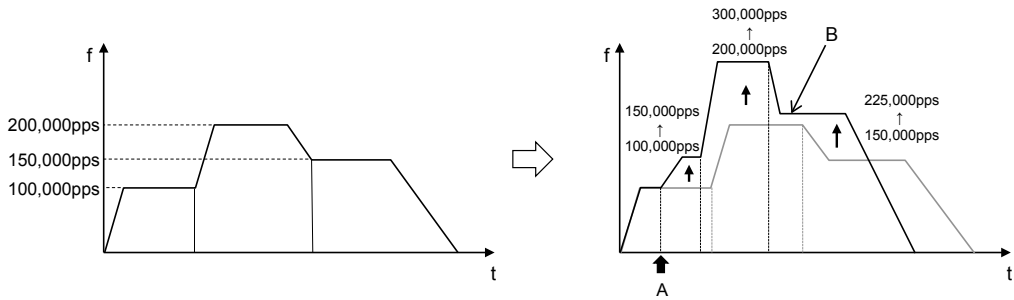

A	The ratio specification is changed from 100 to 150 (%).
B	All consecutive tables follow the set ratio.

17.7 Movement Amount Change Function

17.7.1 Overview

- The movement amount change function is used to change the movement amount on an active positioning table to an arbitrary amount.
- Even when the movement amount is changed, the target speed is the same.

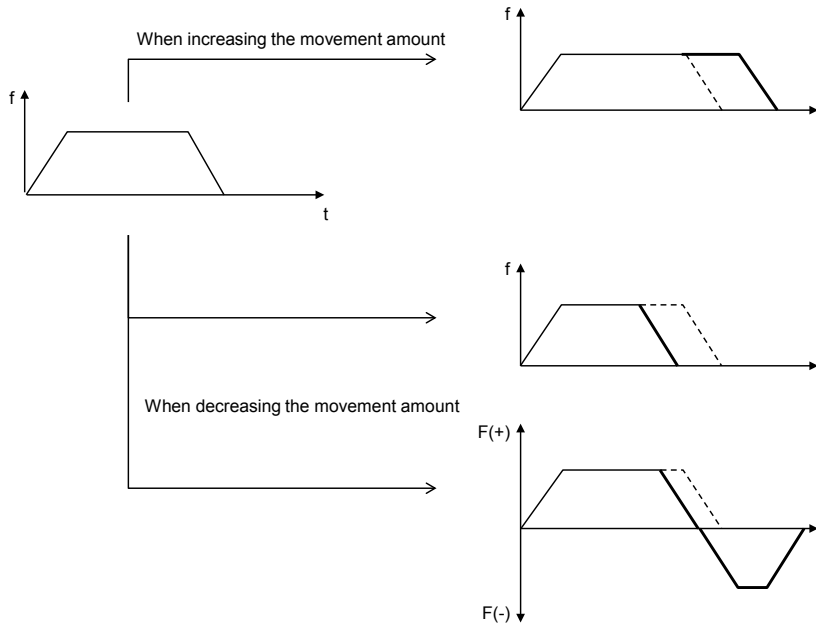

■ Use Conditions

Conditions to use the movement change function are as follows

Position control	Control method	Separate axis control	A	<ul style="list-style-type: none"> • In the case of the synchronous control, the movement amount can be changed only for the master axis. (Slave axes operate according to the master axis.)
		Interpolation control	N/A	
		Synchronous Control	A	
	Operation pattern	E-point	A	<ul style="list-style-type: none"> • The movement amount can be changed more than once in one table. • The movement amount cannot be changed during the deceleration in accordance with the stop operation. • The movement amount cannot be changed during the deceleration in the C point control. • The movement amount cannot be changed during the dwell time in the C point control.
		P-point	A	
		C-point	A	
		J-point	N/A	
		Repetition control	A	
	JOG operation		N/A	
	Home return		N/A	

A: Available, N/A: Not available

17.7.2 Setting Procedures and Operations

■ Setting procedures and operations of movement amount change function

The movement amount change function is activated by the following procedure during a positioning operation.

1. Set "Change movement amount" in the positioning memory.
2. Turn on the "Movement amount change request" contact during a positioning operation.

* "Movement amount change done annunciation" turns ON when the movement amount change is actually started.

* Once the "Speed change request" contact turns OFF, the "Speed change done annunciation" also turns OFF.

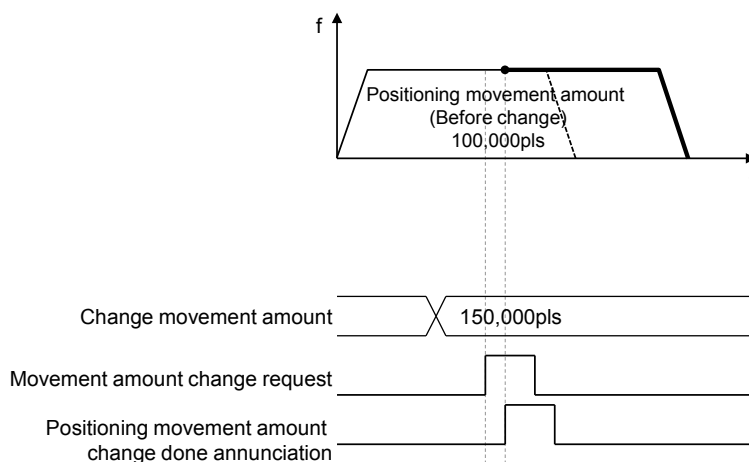

■ Setting parameters

The following parameters are used in the movement amount change function.

Positioning operation change setting area (Positioning memory area No.3)

Offset address (Hex)	Name	Initial value	Description
HA-HB	Positioning movement amount change Change movement amount	H0	Area for setting a change movement amount for changing the positioning movement amount. -2,147,482,624 to 2,147,482,624 (Specified unit system)

■ Example of operation (1) When reducing the movement amount (Change movement amount > Current value)

Parameter	Setting value
Control method	Incremental
Positioning movement amount (Before change)	10,000 (pls)
Positioning movement amount (After change)	7,000 (pls)

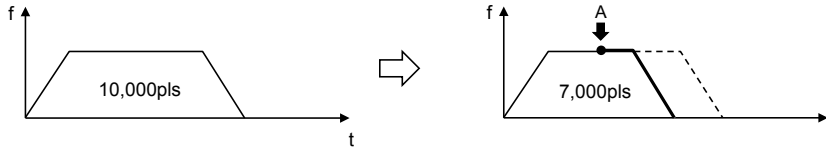

A	Movement amount change request contact ON
---	---

■ Example of operation (2) When reducing the movement amount (Change movement amount < Current value)

Parameter	Setting value
Control method	Incremental
Positioning movement amount (Before change)	10,000 (pls)
Positioning movement amount (After change)	1,000 (pls)

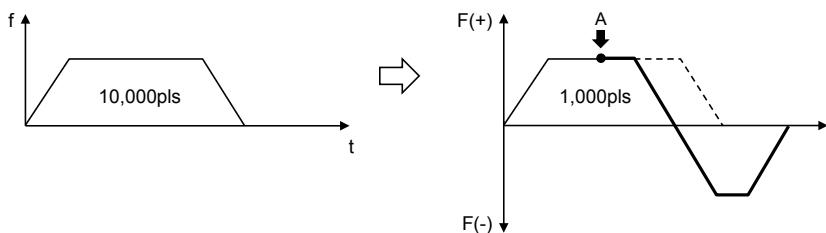

A	Movement amount change request contact ON
---	---

■ Example of operation (3) When a continuous table operation is performed (Incremental)

Parameter	Setting value
Control method	Incremental
First table positioning movement amount (Before change)	5,000 (pls)
First table positioning movement amount (After change)	8,000 (pls)

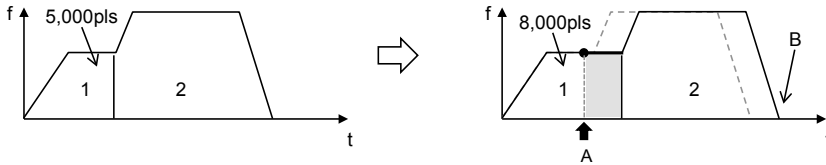

A	Movement amount change request contact ON
B	Because of the increment setting, the stop position of the table 2 also changes.

■ Example of operation (4) When a continuous table operation is performed (Absolute)

Parameter	Setting value
Control method	Absolute
First table positioning movement amount (Before change)	5,000 (pls)
First table positioning movement amount (After change)	8,000 (pls)

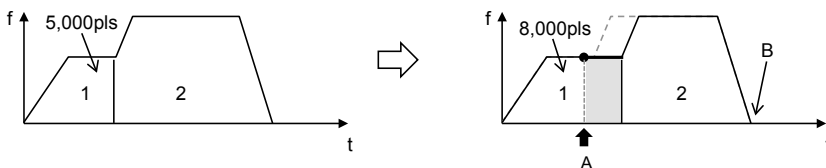

A	Movement amount change request contact ON
B	Because of the absolute setting, the stop position of the table 2 does not change.

■ Example of operation (For repetitive operations)

When the movement amount change is performed during the positioning repeat operation, only the movement amount of the active table in an active repeat period is changed.

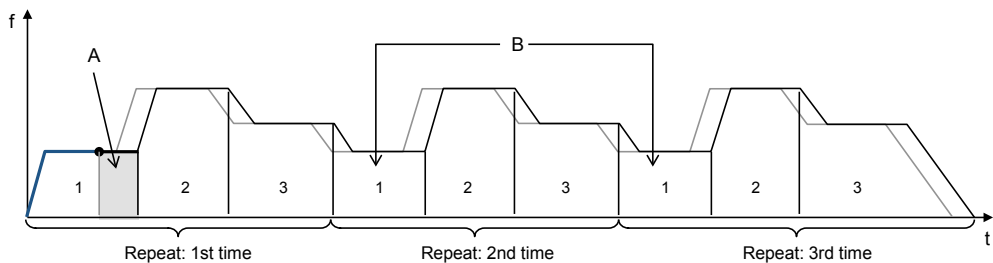
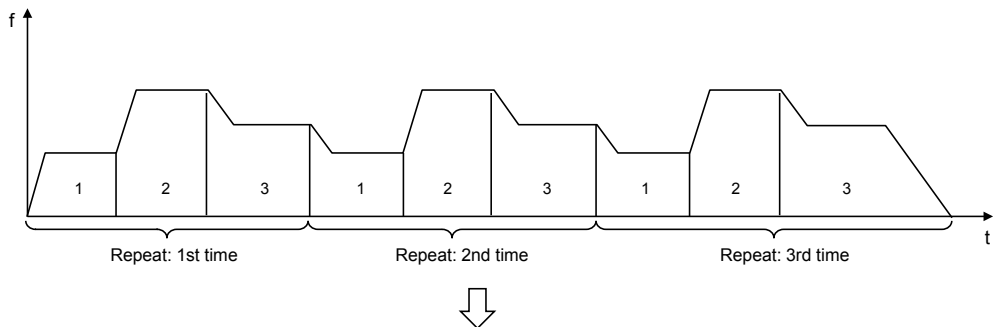

A	Only the movement amount of the table 1 in the first repeat period is changed to 8,000 pls.
B	The movement amounts of the table 1 in the second and third repeat periods are not changed.

■ Auxiliary output when changing movement amounts

Even if the movement amount is changed when the auxiliary output is set in the delay mode, the auxiliary contact turns ON at the position of the delay ratio to the movement amount before the change. If the delay ratio is set to 100%, however, the auxiliary contact turns ON on the completion of the operation.

17.8 Direct Input / Output

17.8.1 Direct Input / Output Function

- The direct input / output function means to update external inputs/outputs during operation.
- In general, the inputs / outputs are updated as a whole during refreshing.
- When direct input instruction is used, read and update external inputs during operation.
- When direct input instruction is used, turn ON/OFF external inputs during operation.
- It is valid for controls with requirement for high-speed response.

■ Types of instructions

Direct input instruction	DST	Direct start
	DST/	Direct start NON
	DAN	Direct AND
	DAN/	Direct AND NON
	DOR	Direct OR
	DOR/	Direct OR NON
Direct output instruction	DOT	Direct output
	DSET	Direct set
	DRST	Direct reset
	DKP	Direct hold

■ Programming method based on FPCWIN GR7

[Direct] selection via the options in the function bar.

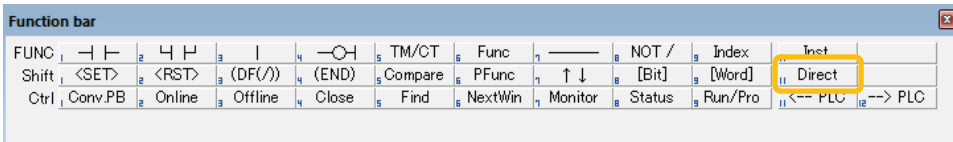
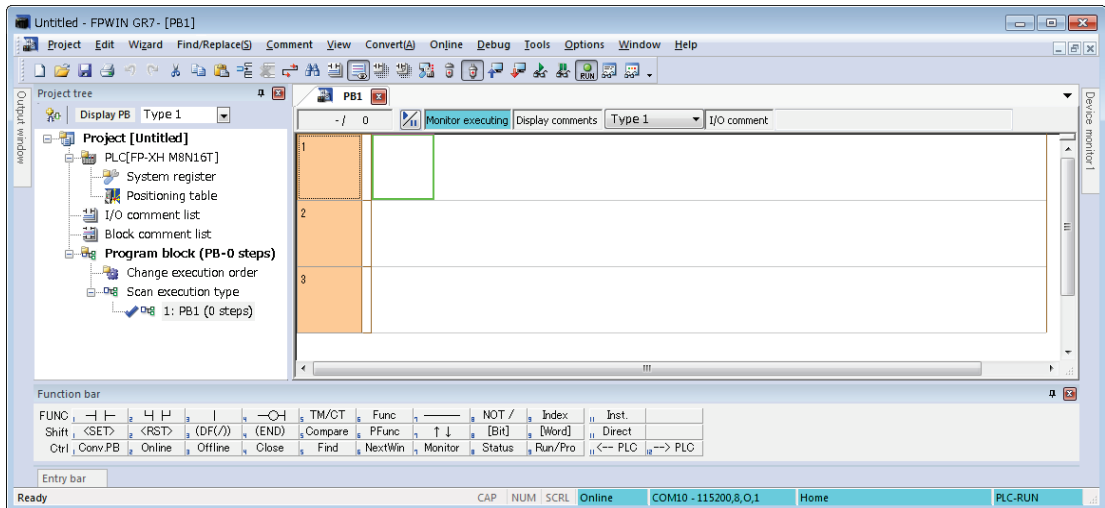

- The function bar is used as direct instruction.

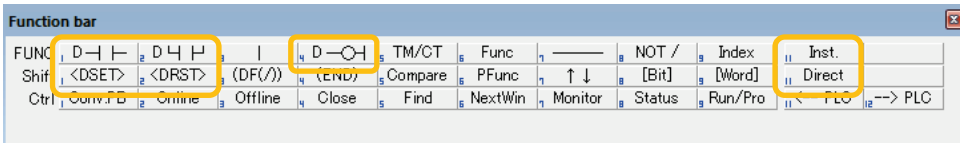

- Select the direct input/output instruction to be used. Select DKP instruction via [Instruction Input].
- Press [Esc] or [Shift] + [f11], the function key bar returns to the common input/output instruction keys.

17.8.2 Direct Input

- Direct Input instructions include DST·DST/·DAN·DAN/·DOR·DOR/ instructions.
- Relay type available for designation includes only X contact.

■ Range that can be specified

Model	Device Range
FP-XH M8N control unit	X0-X7·X1100-X141F (Note)

(Note): When designating X1100-X141F, the input area of the motion control part is read and reflected.

■ Ladder diagram flag

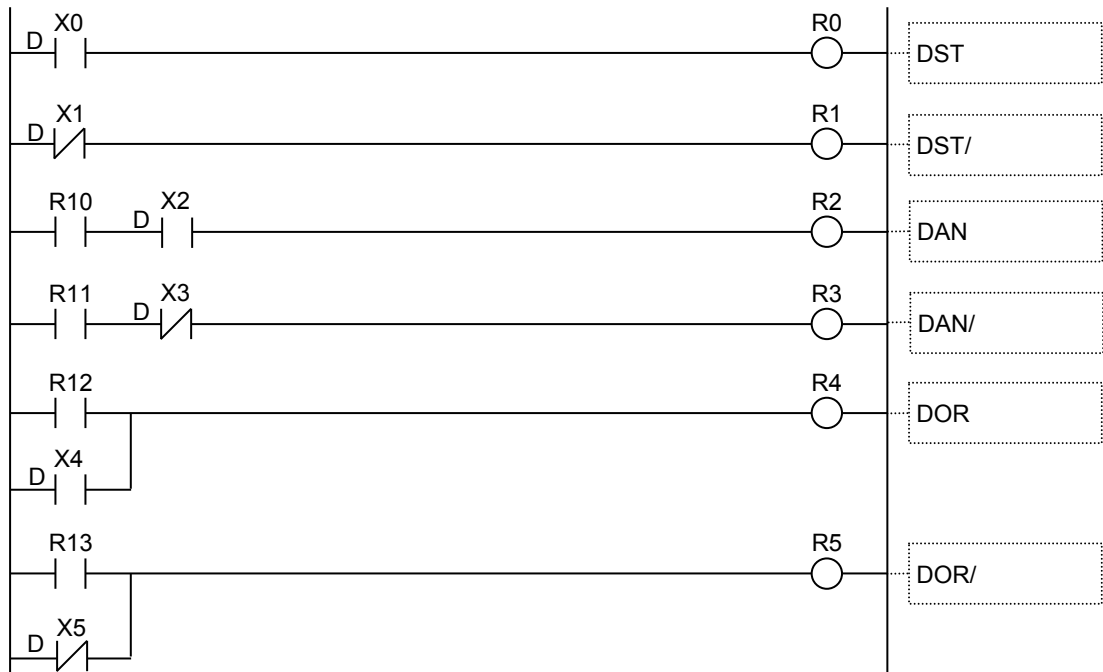

◆ REFERENCE

Please refer to the Instruction Word Reference to instructions for details about the instructions.

17.8.3 Direct Output

- Direct output instructions include DOT, DSET, DRST and DKP.
- Relay type available for designation includes only Y contact.

■ Range that can be specified

Model	Device Range
FP-XH M8N control unit	Y0-Y7 · Y1100-Y141F (Note)

(Note): When designating Y1100-Y141F, the input area of the motion control part is read and reflected.

■ Ladder diagram flag

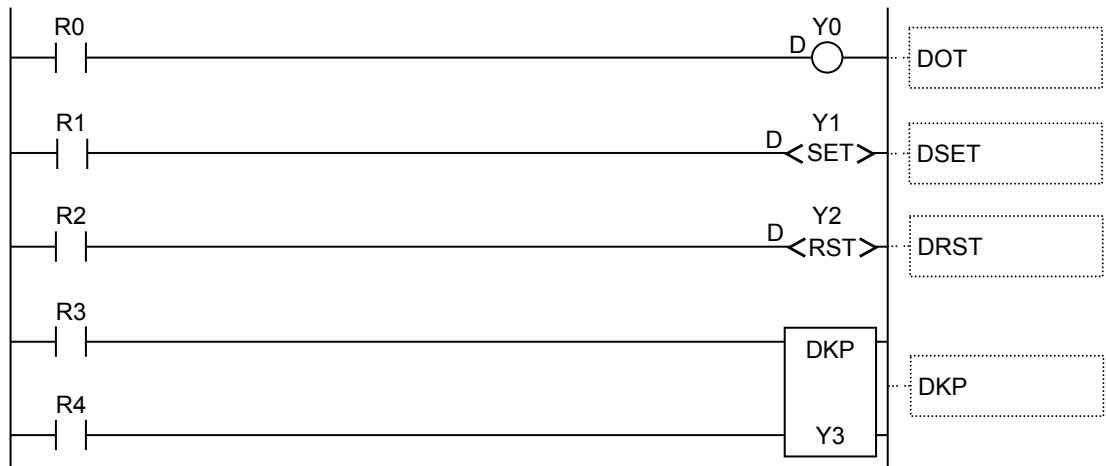

◆ REFERENCE

Please refer to the reference to instructions for details about the instructions.

17.9 Torque Limit

The torque limit is a function to change the maximum output torque of the AMP realtime

- The torque limit function is executed by setting and writing the "Torque limit enable flag" of the positioning memory to "Torque limit value" using a user program. The setting to enable or disable the torque limit and the torque limit values can be set for each axis.
- This function can be executed during the position control, synchronous control and JOG operation. It cannot be executed during the home return operation.
- The torque limit function cannot be executed when the AMP parameter R/W or AMP monitoring is executed.

■ Torque limit setting area (Positioning memory area no. 0)

Offset address (Hex)	Name	Default	Description																																	
H0D8	Torque limit enable flag	H0	Sets whether to enable or disable the execution of the torque limit for each axis. Executes the torque limit when the bit corresponding to each axis turns on.																																	
			<table border="1"> <thead> <tr> <th>bit</th> <th>Name</th> <th>Default</th> <th>Description</th> </tr> </thead> <tbody> <tr> <td>0</td> <td>Torque limit of axis 1</td> <td>0</td> <td rowspan="8">0: Torque limit disabled (default) 1: Torque limit enabled</td> </tr> <tr> <td>1</td> <td>Torque limit of axis 2</td> <td>0</td> </tr> <tr> <td>2</td> <td>Torque limit of axis 3</td> <td>0</td> </tr> <tr> <td>3</td> <td>Torque limit of axis 4</td> <td>0</td> </tr> <tr> <td>4</td> <td>Torque limit of axis 5</td> <td>0</td> </tr> <tr> <td>5</td> <td>Torque limit of axis 6</td> <td>0</td> </tr> <tr> <td>6</td> <td>Torque limit of axis 7</td> <td>0</td> </tr> <tr> <td>7</td> <td>Torque limit of axis 8</td> <td>0</td> </tr> <tr> <td>15~8</td> <td>—</td> <td>—</td> <td>—</td> </tr> </tbody> </table>	bit	Name	Default	Description	0	Torque limit of axis 1	0	0: Torque limit disabled (default) 1: Torque limit enabled	1	Torque limit of axis 2	0	2	Torque limit of axis 3	0	3	Torque limit of axis 4	0	4	Torque limit of axis 5	0	5	Torque limit of axis 6	0	6	Torque limit of axis 7	0	7	Torque limit of axis 8	0	15~8	—	—	—
			bit	Name	Default	Description																														
			0	Torque limit of axis 1	0	0: Torque limit disabled (default) 1: Torque limit enabled																														
			1	Torque limit of axis 2	0																															
			2	Torque limit of axis 3	0																															
			3	Torque limit of axis 4	0																															
			4	Torque limit of axis 5	0																															
			5	Torque limit of axis 6	0																															
			6	Torque limit of axis 7	0																															
7	Torque limit of axis 8	0																																		
15~8	—	—	—																																	
H0D9 -H0DF	Reserved for system	-	-																																	
H0E0	Torque limit value of axis 1	3000	Set the torque limit values. The unit is (0.1%). If 2000 is written in this area, it operates with "2000 x 0.1 = 200 (%)" as the maximum torque.																																	
H0E1	Torque limit value of axis 2	3000																																		
H0E2	Torque limit value of axis 3	3000																																		
H0E3	Torque limit value of axis 4	3000																																		
H0E4	Torque limit value of axis 5	3000																																		
H0E5	Torque limit value of axis 6	3000																																		
H0E6	Torque limit value of axis 7	3000																																		
H0E7	Torque limit value of axis 8	3000																																		

■ Program example

The following sample program shows an example of executing the realtime torque limit during the JOG operation of 1st axis. Set and write the "Torque limit enable flag" of the positioning memory to "Torque limit value" using the user program.

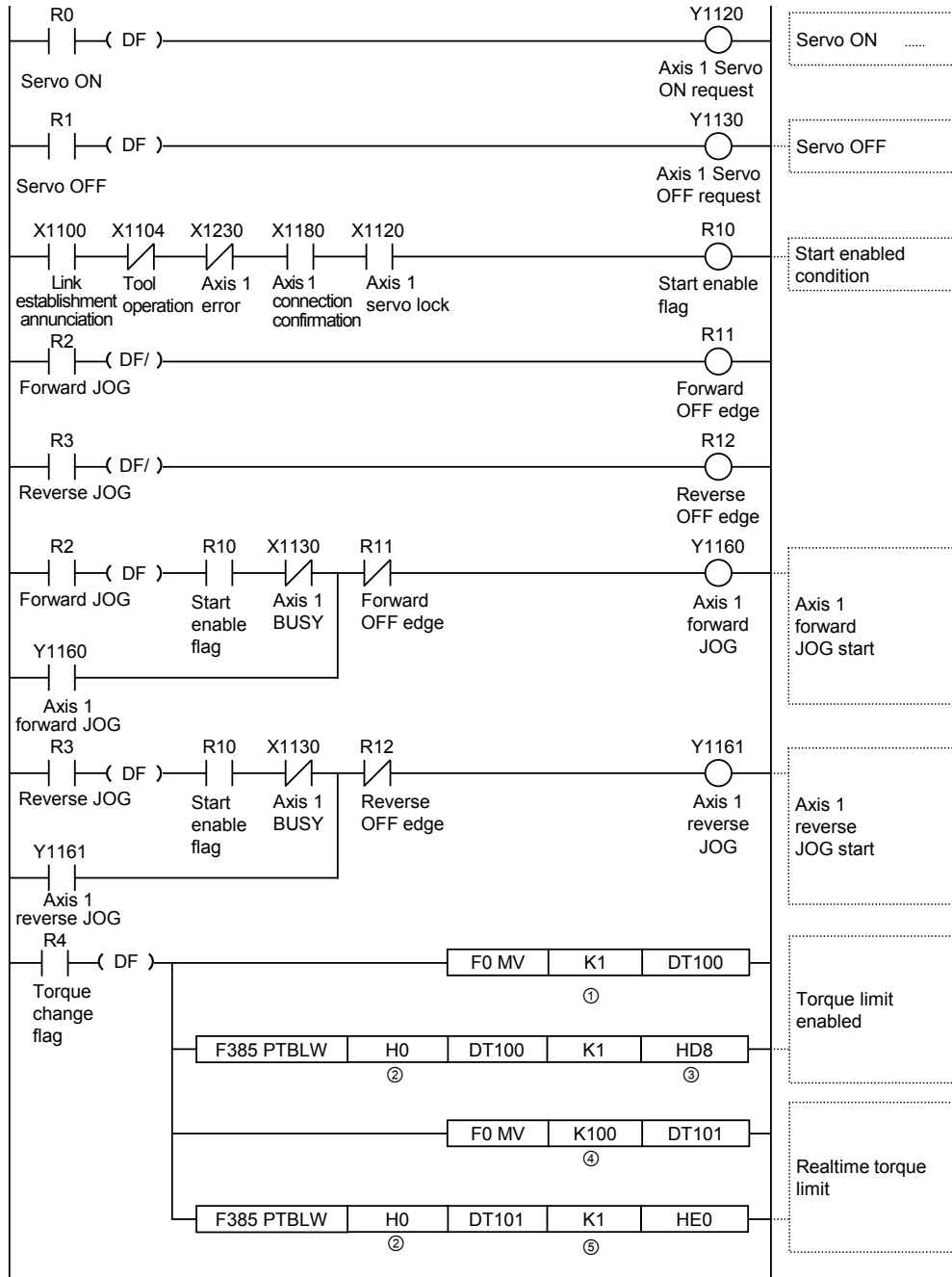

Auxiliary Function

Code	Description	Value specified by program							
		Axis 1	Axis 2	Axis 3	Axis 4	Axis 5	Axis 6	Axis 7	Axis 8
①	Torque limit enable flag area setting value	H1	H2	H4	H8	H10	H20	H40	H80
②	Common area	H0							
③	Torque limit enable flag area	HD8							
④	Torque limit value	Arbitrary value							
⑤	Torque limit value area	HE0	HE1	HE2	HE3	HE4	HE5	HE6	HE7

17.10 Monitor Error (Torque / Actual Speed Judgement)

This is a function to monitor the actual speed/torque of servo amplifier and generate an error or warning on the Control Unit side when it exceeds a set judgement value.

- The monitor error is set in the "Parameter settings" dialog box of Configurator PM7. Judgement values can be set for torque and actual speed separately by respective axes.
- when an error occurs, the operation will stop in the "error stop deceleration time, and cannot be executed until the error is cleared. When a warning occurs, only the occurrence of warning will be informed, and the operation will continue.

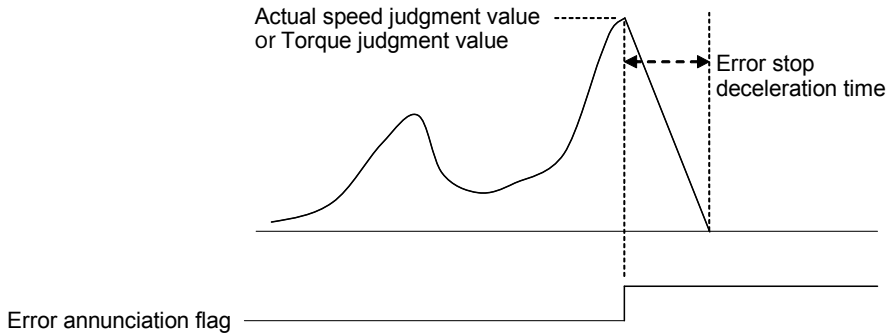

(Note): The above figure shows an operation diagram when error is set.

■ Parameter Settings in Configurator PM7

	Axis 1	Axis 2	Axis 3	Axis 4
Monitor error - Torque judgment	E: Enabled (error)	N: Disabled	N: Disabled	N: Disabled
Monitor error - Torque judgement value (%)	500.0	500.0	500.0	500.0
Monitor error - Actual speed judgment	N: Disabled	W: Enabled (warning)	N: Disabled	N: Disabled
Monitor error - Actual speed judgement value (rpm)	5000	5000	5000	5000

Parameter name	Default	Description
Monitor error - Torque judgment	N: Disabled	Select the operation of the control unit when the torque value of the amplifier exceeds the judgement value. N: Disabled, E: Enabled (Error), W: Enabled (Warning)
Monitor error - Torque judgement value (%)	500.0	Set the torque judgement value. Range: 0-500.0 (%)
Monitor error - Actual speed judgement	N: Disabled	Select the operation of the control unit when the actual speed of the amplifier exceeds the judgement value. N: Disabled, E: Enabled (Error), W: Enabled (Warning)
Monitor error - Actual speed judgement value (rpm)	5000	Set the actual speed judgement value. Range: 0-10000 rpm



◆ REFERENCE

- For details of the errors and warnings, refer to "19 Error/Warning Annunciation Function".

17.11 Operation Done Signal

17.11.1 Operation Done Flag and Imposition Flag

There are two kinds of flags which announces the completion of operation, which are the "operation done flag" controlled by the FP-XH M8N Control Unit and "imposition flag" controlled by the servo amplifier.

■ Operation done flag

- The operation done flag is a signal to confirm the "completion of an operation" on the FP-XH M8N Control Unit side.
- The operation done flag turns off when each operation starts, and turns off when the operation is complete. The completion of the operation differs according to operations.

Operation mode	Timing regarded as the completion of operation
Positioning operation	The operation command for a specified movememnt amount is complete.
JOG operation	The JOG request signal turns off and the the deceleration stop is complete.
Home return	The home return operation is complete (stops at the home position).

- When an arbitrary stop operation such as the deceleration stop, emergency stop or error stop is executed during an operation, the operation done flag turns on when the stop operation is complete.
- The range of the "completion width" regarded as the completion of operation is specified in the FP-XH M8N Control Unit by Configurator PM7 or a user program. The completion width can be set by respective axes.
- The set completion width is transferred to the servo amplifier and set in the parameter "positioning complete (in-position) range" (Pr.4.31) of the servo amplifier.

■ Imposition flag

- The imposition (INP) is a signal to confirm the "completion of positioning operation" on the servo amplifier side.
- Tthe conditions and output setting of "imposition" state are set in the servo amplifier using PANATERM.
- It can be monitored on the FP-XH M8N Control Unit via the positioning memory.

17.12 Position Deviation Simple Monitor

"Position deviation simple monitor" is a function to monitor the difference between the current position controlled within the FP-XH M8N Control Unit and the AMP current position fed back from the AMP.

- The deviation can be read from the each axis information area in the positioning memory using a user program.
- It can also be monitored by the "data monitor function" of Configurator PM7.

■ Monitoring by the FP-XH M8N Control Unit

The position deviation of the first axis is read and written to DT0 to DT1 and monitored.



Code	Content specified by program	Value specified by program							
		Axis 1	Axis 2	Axis 3	Axis 4	Axis 5	Axis 6	Axis 7	Axis 8
①	Axis no. and each axis information area	H1	H101	H201	H301	H401	H501	H601	H701
②	Deviation	H34							



◆ KEY POINTS

- As the deviation read by the "position deviation simple monitor" function is calculated in the FP-XH M8N Control Unit, the difference between this value and the deviation counter value in the AMP may occur.
- -The display of the position deviation monitor is updated by 10 ms.

17.13 AMP Parameter R/W Function

17.13.1 Overview

The FP-XH M8N Control Unit can execute the following operations for the amplifiers connected to the network. Any of these operations can be controlled with user programs through the AMP parameter control area (memory area no. 6 address H0-H27) in the positioning memory of the FP-XH M8N Control Unit.

■ **Type of operation (●: Executable, Blank: Inexecutable)**

Operation	Description	State of target axis	
		Axis is stopping	Axis is active
Reading AMP parameters	Reads parameters from the AMP and stores them in the positioning memory (AMP parameter control area) of the FP-XH M8N Control Unit.	●	● (Note 1)
Writing AMP parameters	Writes the values stored in the positioning memory (AMP parameter control area) of the FP-XH M8N Control Unit to the AMP.	●	
Saving AMP parameters (EEPROM write)	Writes the parameters set in the AMP to the EEPROM built in the AMP.	●	
Resetting AMP (Restart)	Resets the AMP.	● (Note 2)	

(Note 1): Reading parameters cannot be executed during home return.

(Note 2): Resetting the AMP should be executed when all axes are stopping.



◆ **NOTE**

- Turn all axes connected to the network into the servo off state when executing the AMP reset function. When the AMP is reset, all the connected axes will result in error and be in the servo off state because the network is disconnected.
- When the network disconnection error occurs, this function cannot be executed because communication is not available.

17.13.2 Reading Parameters from AMP

Reading parameters from the AMP is performed by the following procedure using user programs.

Step	Description
①	Confirm that the target axes exist in the network (For 1 axis: X1180 = ON).
②	Set the following items in the AMP parameter control area (memory area no.6, address H0/H3/H24). (AMP ID no., parameter classification, parameter no.)
	Set the control flag in the AMP parameter control area (memory area no. 6, address H1) to "H2 (Read request)". The FP-XH M8N Control Unit requests the reading of the parameters to the AMP.
③	On the processing is complete, "H0 (No request)" is stored for the control flag in the AMP parameter control area (memory area no. 6, address H1).
④	Confirm if the status of the AMP parameter control area (memory area no. 6, address H2) is H2 (normal end). If any error occurs, H4 to H6 area stored.
⑤	Read the parameter values from the AMP parameter control area (memory area no. 6, address H26-H27) and written to an arbitrary area.

■ Program example

The following sample program shows the case when the AMP parameter Pr.1.01 of the first axis is read.

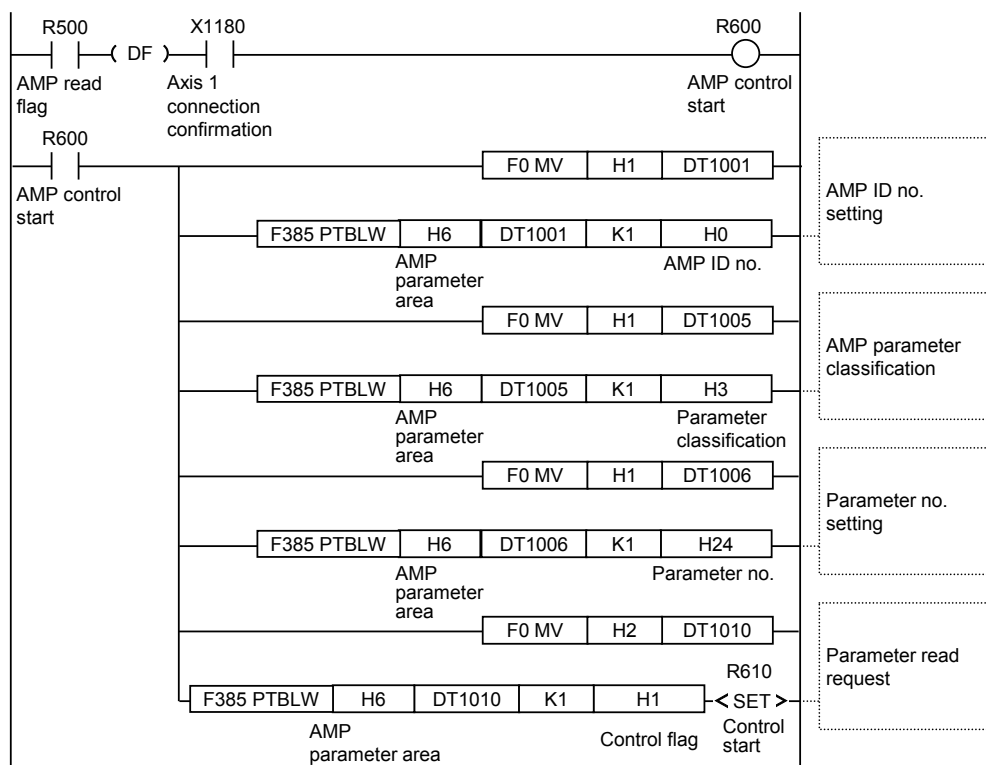

➡ To the next page

Auxiliary Function

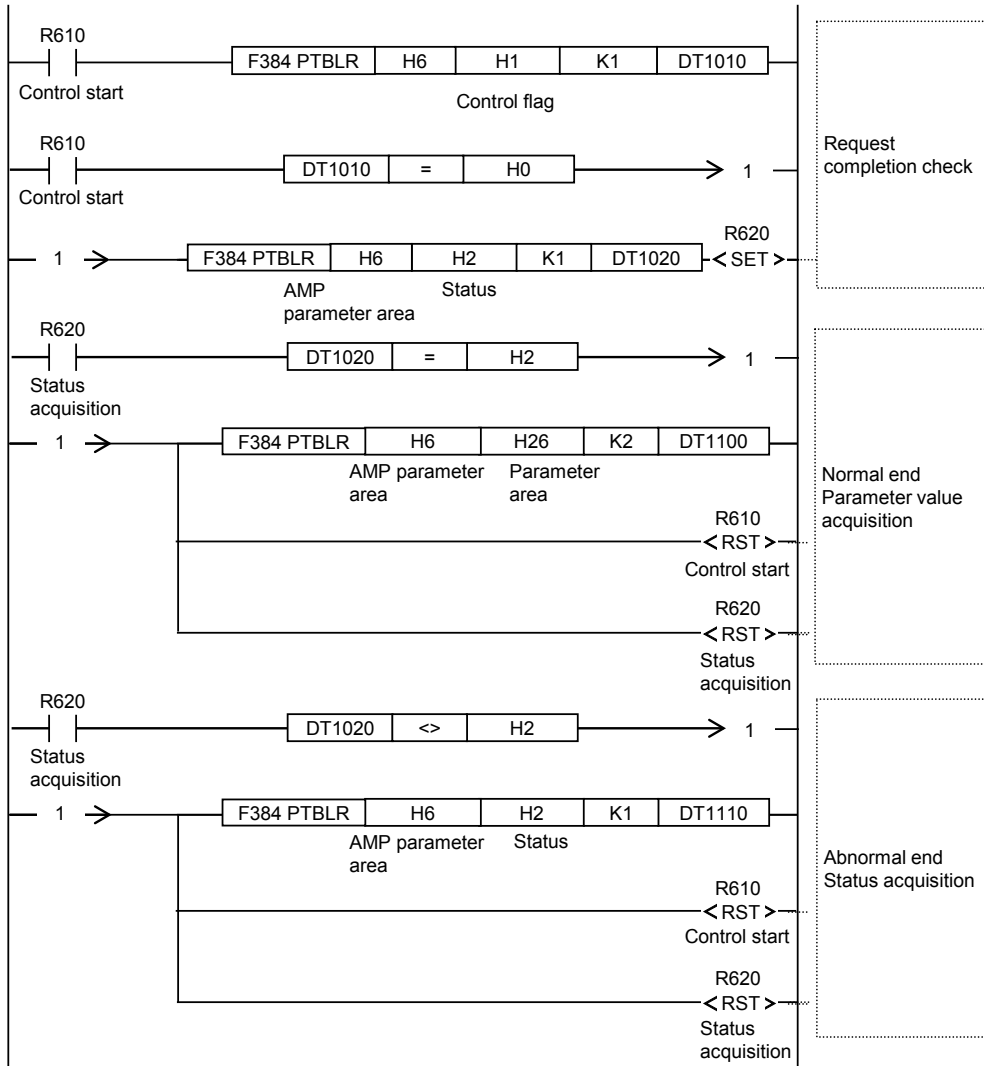

17.13.3 Writing Parameters to AMP

Writing parameters to the AMP is performed by the following procedure using user programs.

Step	Description
①	Confirm that all axes are not activated.
②	Set the following items in the AMP parameter control area (memory area no.6, address H0/H3/H24/H26-H27). (AMP ID no., parameter classification, parameter no., parameter data (2-word))
	Set the control flag in the AMP parameter control area (memory area no. 6, address H1) to "H4 (Write request)". The FP-XH M8N Control Unit requests the writing of the parameters to the AMP.
③	On the processing is complete, "H0 (No request)" is stored for the control flag in the AMP parameter control area (memory area no. 6, address H1).
④	Confirm if the status of the AMP parameter control area (memory area no. 6, address H2) is H2 (normal end). If any error occurs, H4 to H6 area stored.

■ Program example

The following sample program shows the case when the AMP parameter Pr.1.01 of the first axis is written.

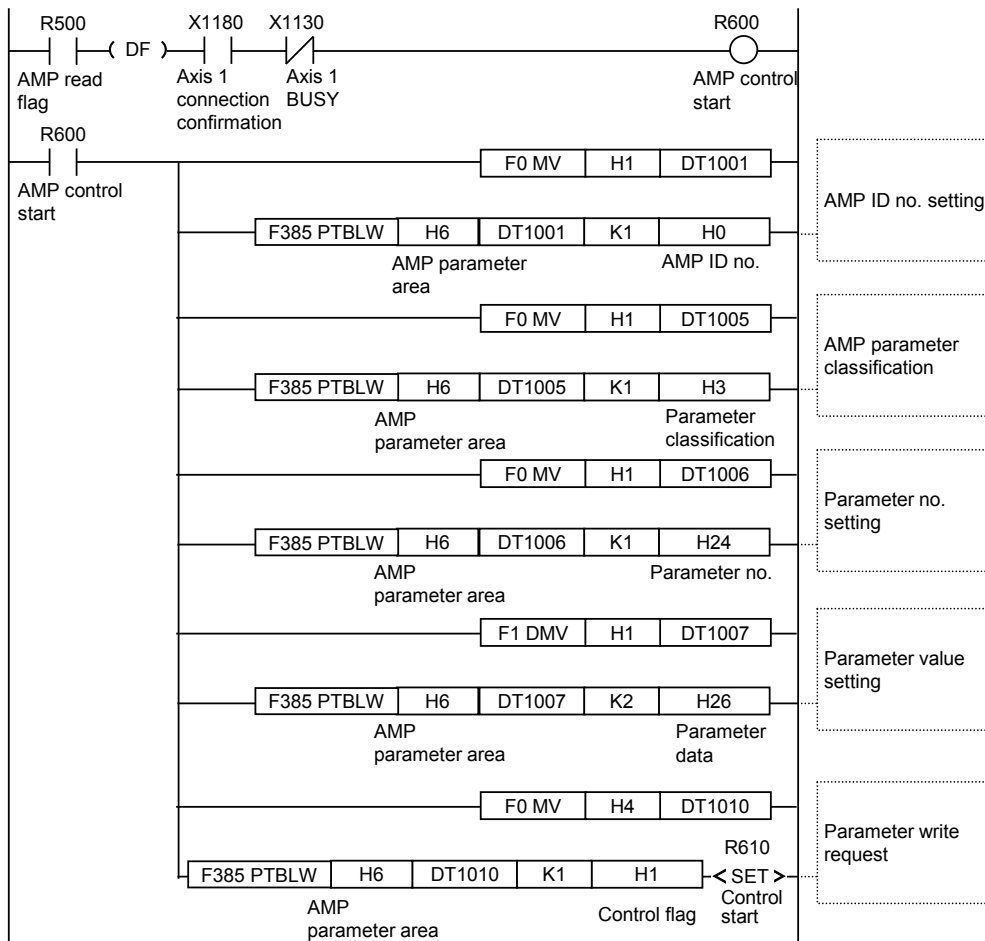

Auxiliary Function

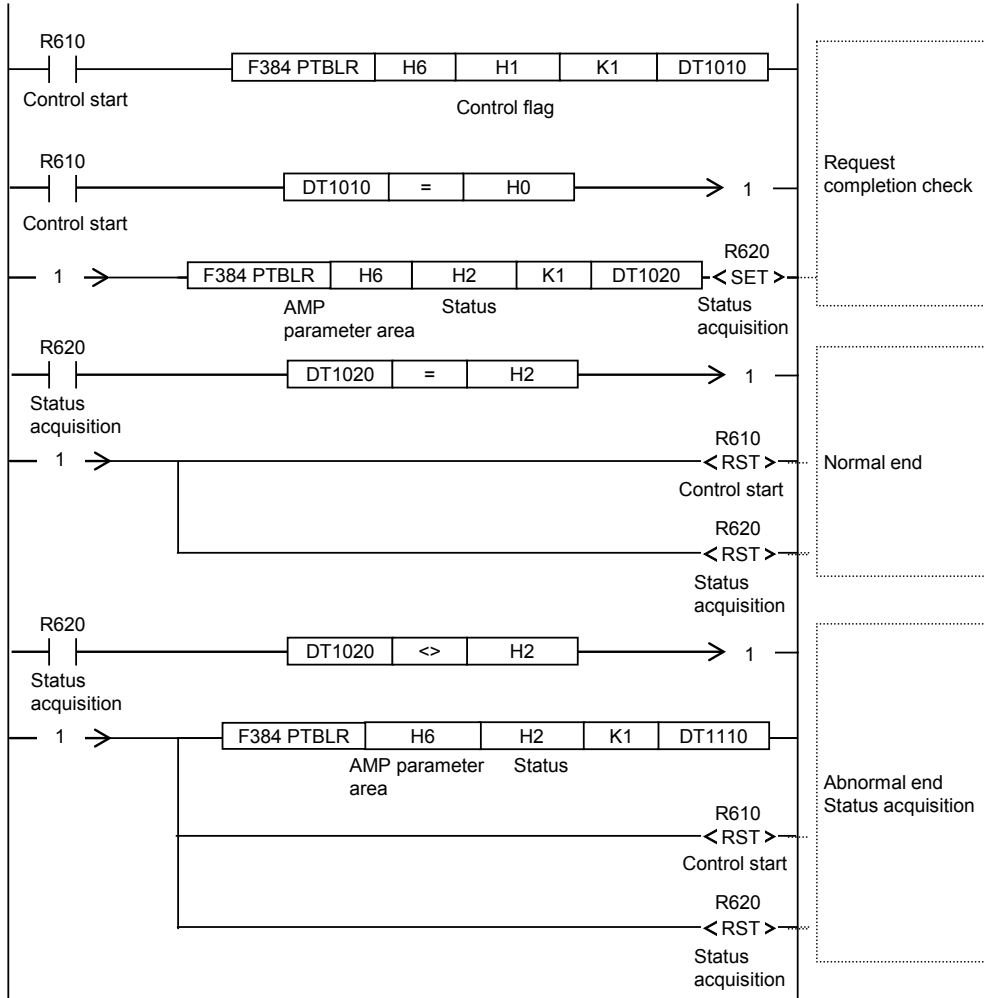

17.13.4 Saving AMP Parameters (Writing to EEPROM)

Writing AMP parameters to the EEPROM is performed by the following procedure using user programs.

Step	Description
①	Confirm that all axes are not activated.
②	Set the control flag in the AMP parameter control area (memory area no. 6, address H1) to "H5 (EEPROM request)". The FP-XH M8N Control Unit requests the writing of the AMP parameters to the EEPROM.
③	On the processing is complete, "H0 (No request)" is stored for the control flag in the AMP parameter control area (memory area no. 6, address H1).
④	Confirm if the status of the AMP parameter control area (memory area no. 6, address H2) is H2 (normal end). If any error occurs, H4 or H6 area stored.

■ Program example

The following sample program shows the case when the AMP parameters of the first axis are saved.

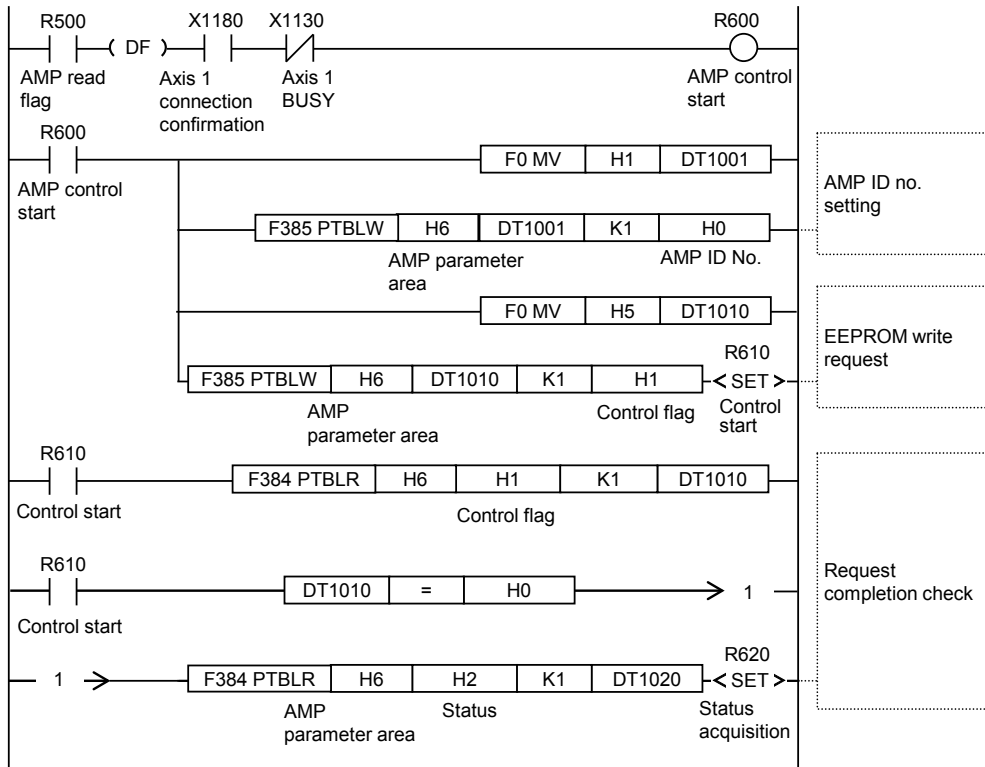

➡ To the next page

Auxiliary Function

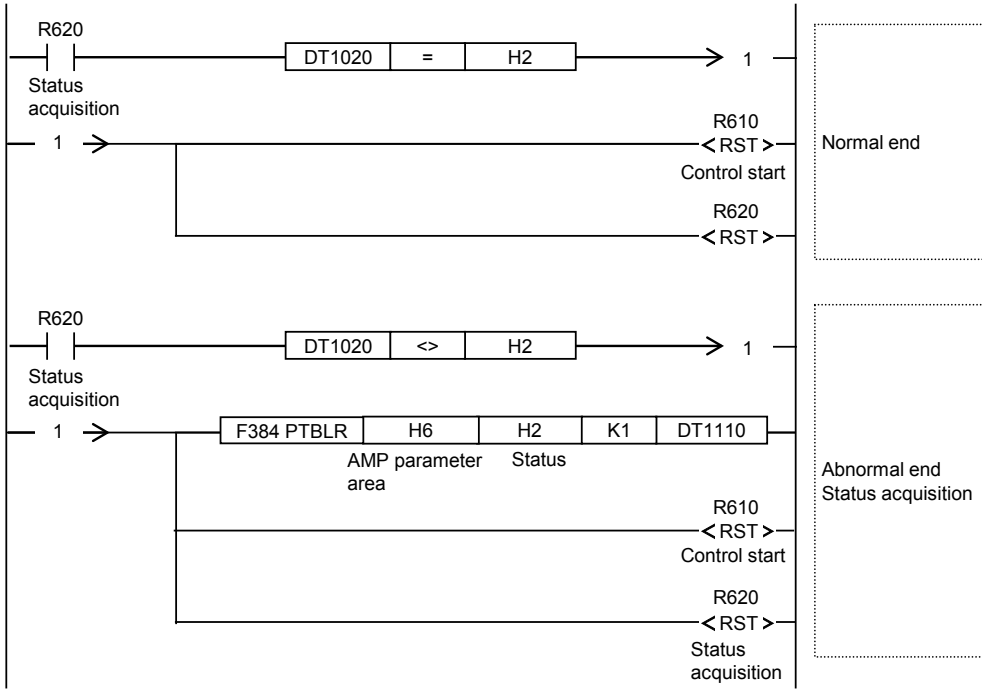

17.13.5 Resetting AMP (Restart)

Resetting the AMP is performed by the following procedure using user programs.

Step	Description
①	Confirm that all axes are not activated.
②	Set the control flag in the AMP parameter control area (memory area no. 6, address H1) to "H6 (AMP reset request)". The FP-XH M8N Control Unit requests the resetting AMP.
③	On the processing is complete, "H0 (No request)" is stored for the control flag in the AMP parameter control area (memory area no. 6, address H1).
④	Confirm if the status of the AMP parameter control area (memory area no. 6, address H2) is H2 (normal end). If any error occurs, H4 or H6 area stored.

■ Program example

The following sample program shows the case when the AMP of the first axis (ID) is reset.

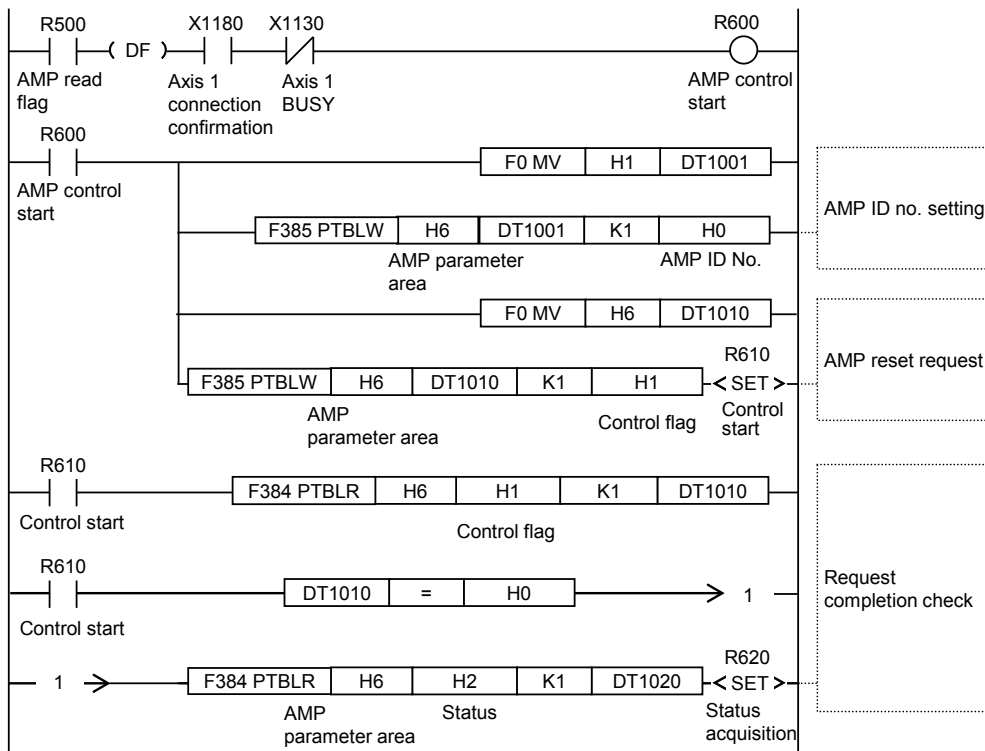

➡ To the next page

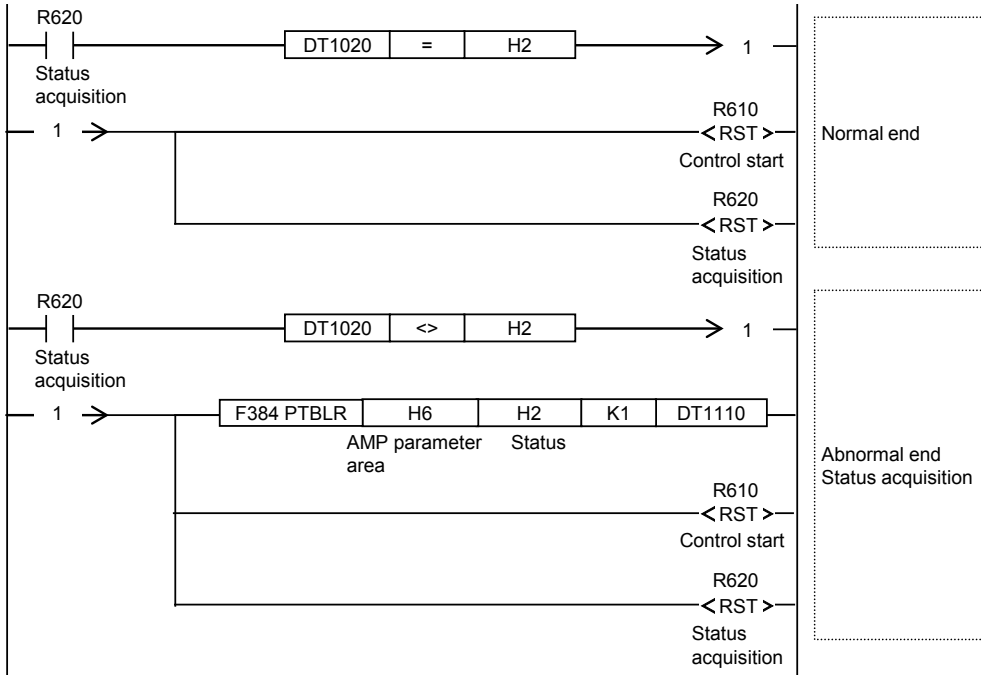

NOTE

- When the AMP is reset, all the connected axes will result in error and be in the servo off state because the network is disconnected.

17.14 AMP Monitoring Function

17.14.1 Overview

This function enables the FP-XH M8N Control Unit to monitor the status information of servo amplifier using RTEX monitor commands.

- This information can be read by controlling the AMP monitor & control area (common area no. 0, address H390-H395) in the positioning memory of the FP-XH M8N Control Unit using user programs.
- The AMP monitor function can be executed only when the axes to be monitored stop. The monitoring request made while the axes are activated is invalid. However, if the request for monitoring is enabled when the axes stop, the monitoring starts.
- When the network disconnection error occurs, this function cannot be executed because communication is not available.

17.14.2 Monitoring Items

The type codes and names that can be read by the FP-XH M8N Control Unit are as follows.

Type Code (HEX)	Name	Type Code (HEX)	Name
01	Position deviation	31	Inertia ratio
02	Encoder resolution	32	Automatic motor recognition
04	Internal command position (after filtering)	33	Cause of no revolution
05	Actual speed	34	Warning flags
06	Torque	41	Mechanical angle (Single turn data)
07	Actual position	42	Electrical angle
08	Internal command position (before filtering)	43	Multi-turn data
09	Latch position 1	61	Power on cumulative time
0A	Latch position 2	62	Servo driver temperature
0C	Command velocity (after filtering)	63	Encoder temperature
11	Regenerative load ratio	64	No. of inrush resistance relay operations
12	Overload ratio	65	No. of dynamic brake operations
21	Logical input signal	66	Fan operating time
22	Logical output signal	67	Fan life expectancy
23	Logical input signal (expansion portion)	68	Capacitor life expectancy
24	Logical output signal (expansion portion)	69	Voltage across PN
25	Physical input signal	71	RTEX cumulative communication errors
26	Physical output signal	81	Encoder cumulative communication errors

Auxiliary Function

(Note): Refer to the latest instruction manual and technical materials of the servo amplifier.

17.14.3 Monitoring Procedure

Monitoring the status information is performed by executing the following items using user programs.

1. AMP monitor & control area

Set the axis number (AMP ID No.) to be read to AMP ID number.

Set the control flag for the type code to be monitored.

2. The RTE sets H1 (Being processed) for the status, and stores the monitor value in the monitor data.

3. Check if the status of the AMP monitor & control area is H2 (Normal end).

4. Read the monitor data.

■ Program example

When monitoring the encoder temperature (type code 63) of the first axis

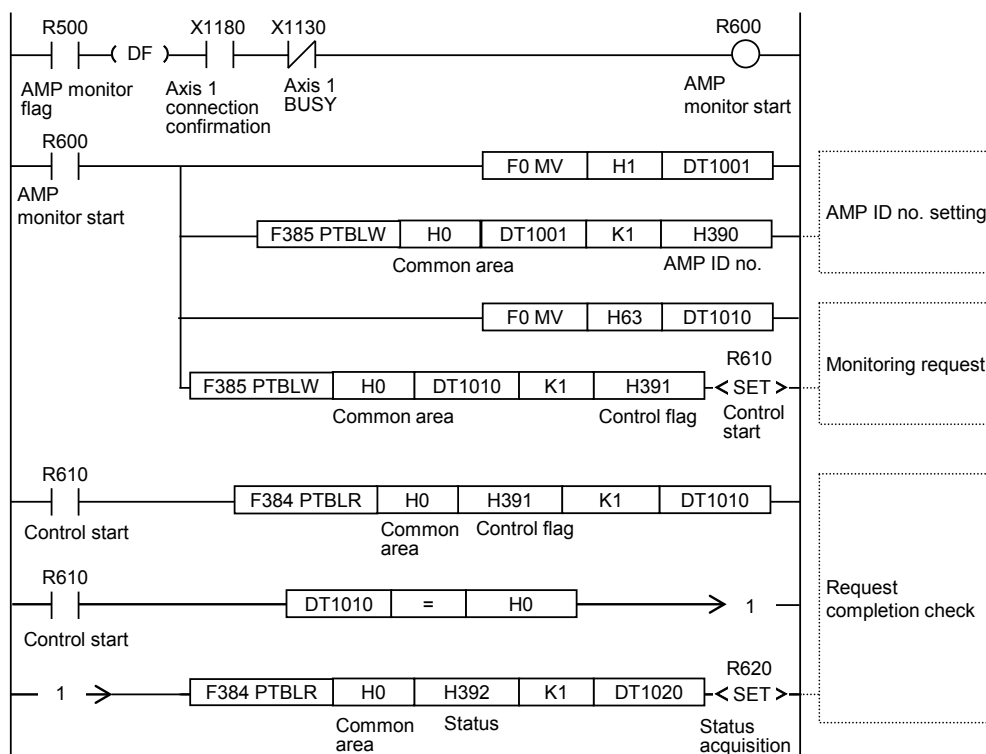

➡ To the next page

Auxiliary Function

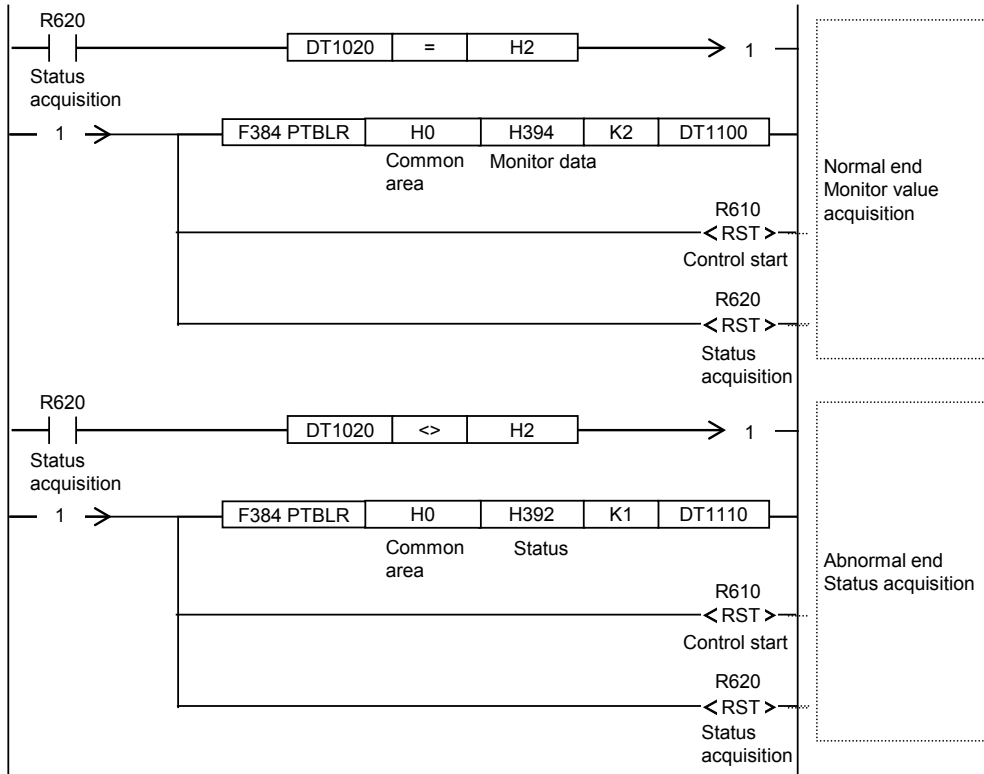

18

Instruction Reference

18.1 Motion Control Instructions

18.1.1 [F384 PTBLR] Positioning parameter read instruction

Read the position control parameter saved in the unit positioning memory to the area of memory for operation.

■ Instruction format



■ Operand

Operand	Settings			
S1	Specify the axis number and positioning memory area			
	<table border="1"> <tr> <td>(upper bit 8bit) axis number:</td> <td>H0 (Axis 1), H1 (Axis 2), H2 (Axis 3), H3 (Axis 4), H4 (Axis 5), H5 (Axis 6), H6 ((virtual) Axis 7), H7 ((virtual) Axis 8)</td> </tr> <tr> <td>(lower bit 8bit) area number:</td> <td>H0 (common area), H01 (axis information area), H02 (axis setting area), H04 (synchronous control setting area), H05 (position control operation change setting area) and H06 (AMP parameter area)</td> </tr> </table>	(upper bit 8bit) axis number:	H0 (Axis 1), H1 (Axis 2), H2 (Axis 3), H3 (Axis 4), H4 (Axis 5), H5 (Axis 6), H6 ((virtual) Axis 7), H7 ((virtual) Axis 8)	(lower bit 8bit) area number:
(upper bit 8bit) axis number:	H0 (Axis 1), H1 (Axis 2), H2 (Axis 3), H3 (Axis 4), H4 (Axis 5), H5 (Axis 6), H6 ((virtual) Axis 7), H7 ((virtual) Axis 8)			
(lower bit 8bit) area number:	H0 (common area), H01 (axis information area), H02 (axis setting area), H04 (synchronous control setting area), H05 (position control operation change setting area) and H06 (AMP parameter area)			
S2	Initial address of the positioning memory in which data to be read will be saved (offset address) or memory for computation in which initial address will be saved			
n	Read the number of words			
D	Save the operation memory of the read data			

(Note 1): The setting of axis number is invalid when reading common area. Please specify H0 is S1.

(Note 2): Designate the operand S1 via the hex combination. For the axis information area of axis number 3, it is designated to H201.

■ Memory area type that can be specified (A: Available, -: Not available)

Operand	WX	WY	WR	WL	SV	EV	DT	LD	I	Constant		Index modifier
										K	H	
S1	A	A	A	A	A	A	A	A	A	A	A	A
S2	A	A	A	A	A	A	A	A	A	A	A	A
n	A	A	A	A	A	A	A	A	A	A	A	A
D	-	A	A	A	A	A	A	A	A	-	-	A

■ Operation description

- Read the data saved in positioning memory with [n] word starting with [S2], and save it to the memory area for computation starting with [D].
- Use [S1] to designate axis number and area number of positioning memory.

■ Precautions for programming

- When the number of operations exceeds the specified range, operating error will occur.

18.1.2 [F385 PTBLW] Positioning parameter write instruction

This is used when writing in position control parameter and data of position control data table through the user program.

■ Instruction format

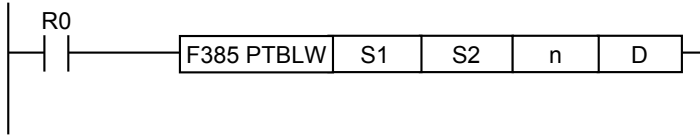

■ Operand

Operand	Settings			
S1	Specify the axis number and positioning memory area			
	<table border="1"> <tr> <td>(upper bit 8bit) axis number:</td> <td>H0 (Axis 1), H1 (Axis 2), H2 (Axis 3), H3 (Axis 4), H4 (Axis 5), H5 (Axis 6), H6 ((virtual) Axis 7), H7 ((virtual) Axis 8)</td> </tr> <tr> <td>(lower bit 8bit) area number:</td> <td>H0 (common area), H01 (axis information area), H02 (axis setting area), H04 (synchronous control setting area), H05 (position control operation change setting area) and H06 (AMP parameter area)</td> </tr> </table>	(upper bit 8bit) axis number:	H0 (Axis 1), H1 (Axis 2), H2 (Axis 3), H3 (Axis 4), H4 (Axis 5), H5 (Axis 6), H6 ((virtual) Axis 7), H7 ((virtual) Axis 8)	(lower bit 8bit) area number:
(upper bit 8bit) axis number:	H0 (Axis 1), H1 (Axis 2), H2 (Axis 3), H3 (Axis 4), H4 (Axis 5), H5 (Axis 6), H6 ((virtual) Axis 7), H7 ((virtual) Axis 8)			
(lower bit 8bit) area number:	H0 (common area), H01 (axis information area), H02 (axis setting area), H04 (synchronous control setting area), H05 (position control operation change setting area) and H06 (AMP parameter area)			
S2	Save the memory area for operational to which data is written			
n	Number of words written			
D	Initial address of the positioning memory to which data is saved (offset address) or memory for computation in which initial address will be saved			

(Note 1): The setting of axis number is invalid when being written to common area. Please specify H0 is S1.

(Note 2): Designate the operand S1 via the hex combination. For the axis setting area of axis number 3, it is designated to H202.

■ Memory area type that can be specified (A: Available, -: Not available)

Operand	WX	WY	WR	WL	SV	EV	DT	LD	I	Constant		Index modifier
										K	H	
S1	A	A	A	A	A	A	A	A	A	A	A	A
S2	A	A	A	A	A	A	A	A	A	-	-	A
n	A	A	A	A	A	A	A	A	A	A	A	A
D	A	A	A	A	A	A	A	A	A	A	A	A

■ Operation description

- Read the data saved in the area with [n] word starting with [S2], and save it to the positioning memory starting with [D].
- Use [S1] to designate axis number and area number of positioning memory.

■ Precautions for programming

- When the number of operations exceeds the specified range, operating error will occur.



◆ REFERENCE

For details about the positioning memory, see "26.4 Positioning Memory".

18.1.3 [F386 PSET] Positioning start data table setting

Written before the program starting the position control to set the position control data table to be started.

■ Instruction format

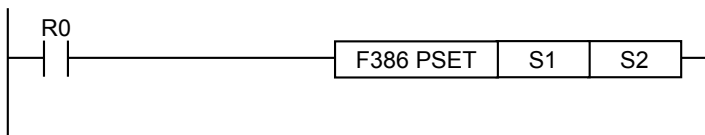

■ Operand

Operand	Settings
S1	Numbers of axes to start position control data tables: H0 (Axis 1), H1 (Axis 2), H2 (Axis 3), H3 (Axis 4), H4 (Axis 5), H5 (Axis 6), H6 ((virtual) Axis 7), H7 ((virtual) Axis 8)
S2	Numbers of data tables to start position control data tables: 1-600 (standard area), 10001-10089 (extended area)

■ Memory area type that can be specified (A: Available, -: Not available)

Operand	WX	WY	WR	WL	SV	EV	DT	LD	I	Constant		Index modifier
										K	H	
S1	A	A	A	A	A	A	A	A	A	A	A	A
S2	A	A	A	A	A	A	A	A	A	A	A	A

■ Operation description

- Sets position control data table to start.
- When the startup contact of corresponding axis is ON, start position control operation according to the data set in the positioning memory (position control data table area) in advance.

■ Precautions for programming

- When the number of operations exceeds the specified range, operating error will occur.
- When the conditions for system stop, emergency stop, position limit stop and deceleration stop are fulfilled, processing should be stopped with priority.
- When the value set or the positioning memory (axis setting area) is abnormal, self-diagnose error (position control operation error) will occur.
- When the axis to be started is in operation, the operation will stop without starting position control.

18.1.4 [F387 PSTRD] Axis status acquisition

Reads status information indicating position control operations to any device.

■ Instruction format

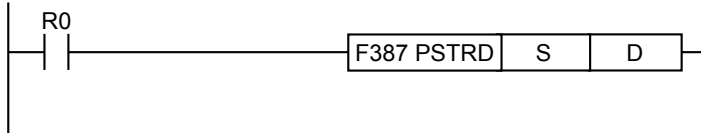

■ Operand

Operand	Settings
S	Numbers of axes to read status: H0 (Axis 1), H1 (Axis 2), H2 (Axis 3), H3 (Axis 4), H4 (Axis 5), H5 (Axis 6), H6 ((virtual) Axis 7), H7 ((virtual) Axis 8)
D	Saves the address of device completing information reading

■ Memory area type that can be specified (A: Available, -: Not available)

Operand	WX	WY	WR	WL	SV	EV	DT	LD	I	Constant		Index modifier
										K	H	
S	A	A	A	A	A	A	A	A	A	A	A	A
D	-	A	A	A	A	A	A	A	A	-	-	A

■ Operation description

- Reads status of the axis designated by [S] to any device.

■ Type of axis status information

Status information	Description
Tool operation	It will be turned ON during tools running with Configurator PM7, irrelevant to the designated axis
Error annunciation	ON when the designated axis is in error
Warning annunciation	ON when the designated axis is in warning
BUSY	ON when the designated axis is operating
Operation done	ON when the operation of the designated axis is completed
Home return done	ON when the designated axis is subject to home return

■ Allocation of axis status information stored in [D]

bit	Status information	Axis 1	Axis 2	Axis 3	Axis 4	Axis 5	Axis 6	Axis 7 (virtual)	Axis 8 (virtual)
0	Tool operation	X1104	X1104	X1104	X1104	X1104	X1104	X1104	X1104
1	Error annunciation	X1230	X1231	X1232	X1233	X1234	X1235	X1236	X1237
2	Warning annunciation	X1240	X1241	X1242	X1243	X1244	X1245	X1246	X1247
3	BUSY	X1130	X1131	X1132	X1133	X1134	X1135	X1136	X1137
4	Operation done	X1140	X1141	X1142	X1143	X1144	X1145	X1146	X1147
5	Home return done	X1150	X1151	X1152	X1153	X1154	X1155	X1156	X1157

■ **Example of storage**

When the status of the axis 1 is as follows, the stored value is H0008.

bit	Status information	Axis 1	Value
0	Tool operation	X1104	0
1	Error annunciation	X1230	0
2	Warning annunciation	X1240	0
3	BUSY	X1130	1
4	Operation done	X1140	0
5	Home return done	X1150	0

→

Stored value
H0008

■ **Precautions for programming**

- When the number of operations exceeds the specified range, operating error will occur.

18.1.5 [F388 PERRD] Positioning error /warning acquisition

Reads codes saved in error annunciation buffer 1/warning buffer 1 to any device.

■ Instruction format

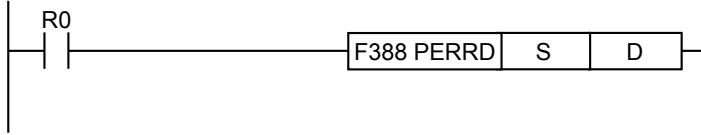

■ Operand

Operand	Settings
S	Numbers of axes to read error/warning codes: H0 (Axis 1), H1 (Axis 2), H2 (Axis 3), H3 (Axis 4), H4 (Axis 5), H5 (Axis 6), H6 ((virtual) Axis 7), H7 ((virtual) Axis 8)
D	Saves the address of device completing information reading

■ Memory area type that can be specified (A: Available, -: Not available)

Operand	WX	WY	WR	WL	SV	EV	DT	LD	I	Constant		Index modifier
										K	H	
S	A	A	A	A	A	A	A	A	A	A	A	A
D	-	A	A	A	A	A	A	A	A	-	-	A

■ Operation description

- Reads codes saved in error annunciation buffer /warning buffer of the designated axis to any device.
- [D] saves error codes and [D+1] saves warning codes.

■ Precautions for programming

- When the number of operations exceeds the specified range, operating error will occur.



◆ REFERENCE

- Please refer to "19.1 Errors and Warnings" for overview about errors and warnings.
- Please refer to "19.3 Table of Error Codes" for error codes.
- Please refer to "19.4 Table of Warning Codes" for warning codes.

18.1.6 [F389 UCLR] Positioning error / warning clearing

Clears codes saved in error annunciation buffer/warning buffer.

■ Instruction format

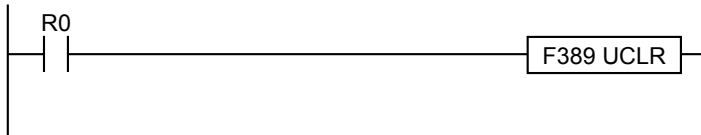

■ Operation description

- Clears position control error annunciations & area and warning annunciations & area contents.

18.2 Direct Input Instruction

18.2.1 [DST·DST/] Direct start / Direct start NOT

DST, DST/: reads external inputs for logical operation. Due to the input refreshing of contact units, it is valid for controls with requirement for high-speed response.

■ Instruction format

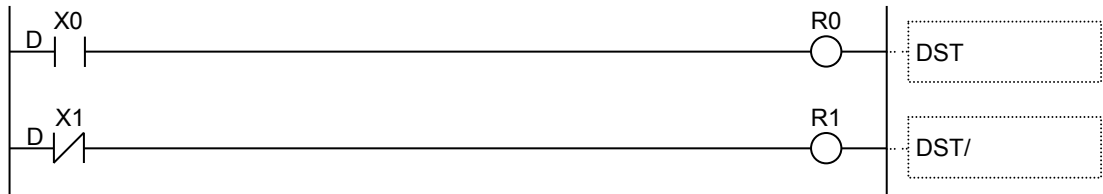

■ Type of relays that can be specified (unit: bit) (A: Available, -: Not available)

		X	Y	R	T	C	L	P	E	Index modifier
DST	Normal ON input contact for the start of logical operation	A	-	-	-	-	-	-	-	A
DST/	Normal OFF input contact for the start of logical operation	A	-	-	-	-	-	-	-	A

■ Operation description

- 「DST」Instruction, read specified external input, reflect it to the input contact, and then take this contact as normally open (NO) contact (a contact) and perform logic operation.
- 「DST/」Instruction, read specified external input, reflect it to the input contact, and then take this contact as normally closed (NC) contact (b contact) and perform logic operation.

<Example> During the above procedure

- When external input X0 flag is ON, R0 flag will be ON.
- When external input X1 flag is OFF, R1 flag will be ON.

■ Range that can be specified

Model	Device Range
FP-XH M8N control unit	X0-X7·X1100-X141F (Note)

(Note): When designating X1100-X141F, the input area of the motion control part is read and reflected.

■ Precautions for programs

- When the contact is out of the specified possible range, operation error may occur.
- When setting the time through main unit input time constant setting function of system register, the time constant will be invalid.

■ **Comparison of ST instruction and DST instruction**

- DST instruction is more suitable for requirement for high-speed response than ST instruction.

<For ST instruction>

● Ladder diagram



● Time chart

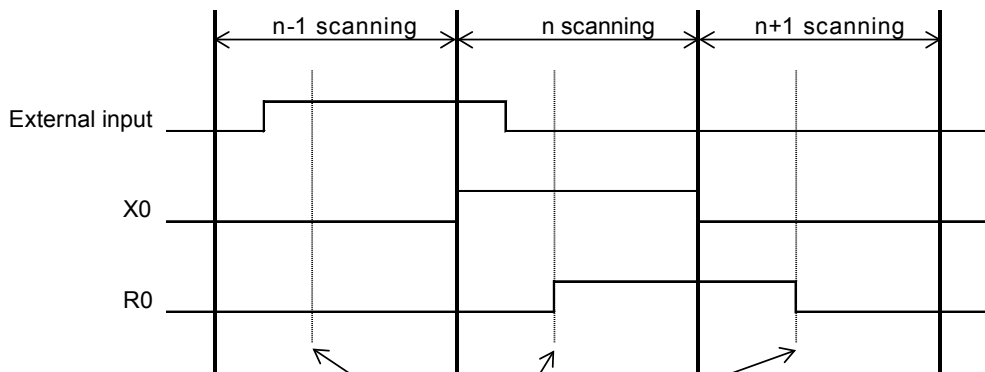

* CPU input time constant setting: None

Execute ST X0

<For DST instruction>

● Ladder diagram



● Time chart

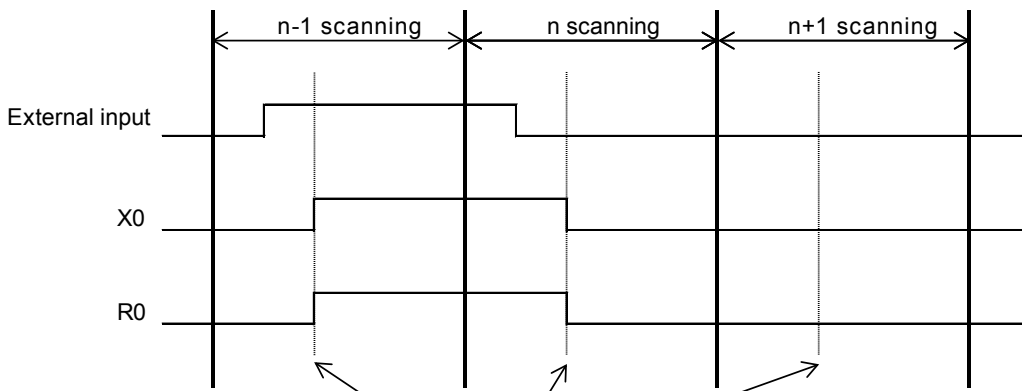

* CPU input time constant setting: None

Execute DST X0

18.2.2 [DAN·DAN/] Direct AND /-Direct AND NOT

DAN: read external input and connect normally open (NO) contacts (a contact) in series. As input refreshing is performed by taking contact as a unit, it is valid for controls with requirement for high-speed response.

DAN/: read external input and connect normally closed (NC) contacts (b contact) in series. As input refreshing is performed by taking contact as a unit, it is valid for controls with requirement for high-speed response.

■ Instruction format

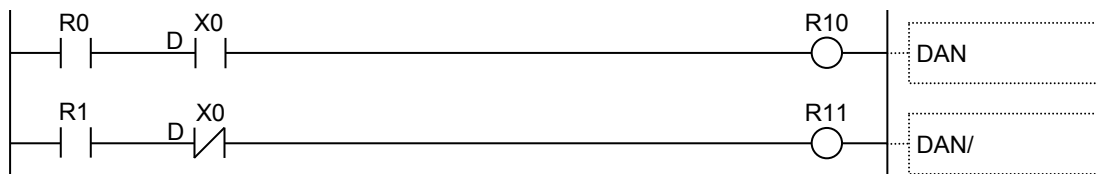

■ Type of relays that can be specified (unit: bit) (A: Available, -: Not available)

		X	Y	R	T	C	L	P	E	Index modifier
DAN	Normally open (NO) contacts connected in a line	A	-	-	-	-	-	-	-	A
DAN/	Normally closed (NC) contacts connected in series	A	-	-	-	-	-	-	-	A

■ Operation description

- Read specified external input and reflect it to output contact, and then perform logic multiply operation with the current result calculated with contacts connected in series.

<Example> During the above procedure

- When R0 flag is ON and external input X0 flag is ON, R10 flag will be ON.
- When R1 flag is ON and external input X0 flag is OFF, R11 flag will be ON.

■ Range that can be specified

Model	Device Range
FP-XH M8N control unit	X0-X7·X1100-X141F (Note)

(Note): When designating X1100-X141F, the input area of the motion control part is read and reflected.

■ Precautions for programs

- When the contact is out of the specified possible range, operation error may occur.
- When setting the time through main unit input time constant setting function of system register, the time constant will be invalid.

■ Comparison of AN instruction and DAN instruction

- DAN instruction is more suitable for requirement for high-speed response than AN instruction.

<For AN instruction>

● Ladder diagram



● Time chart

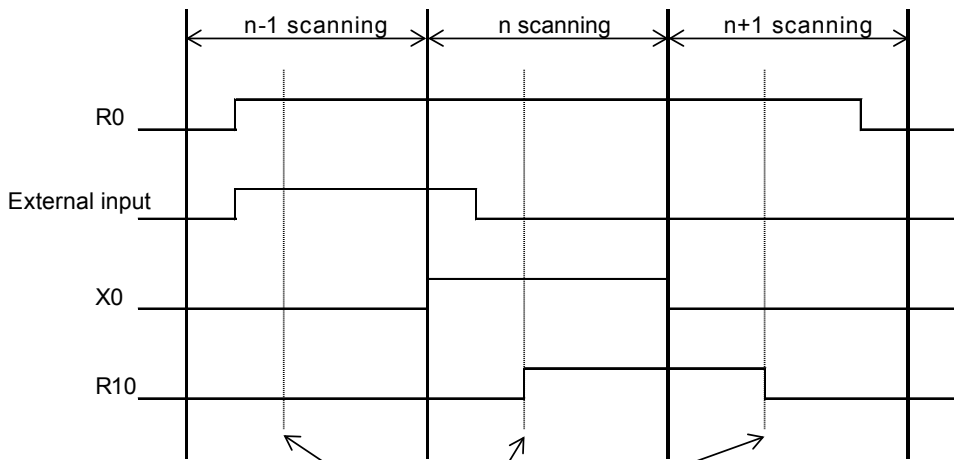

*CPU input time constant setting: None

Execute AN X0

<For DAN instruction>

● Ladder diagram



● Time chart

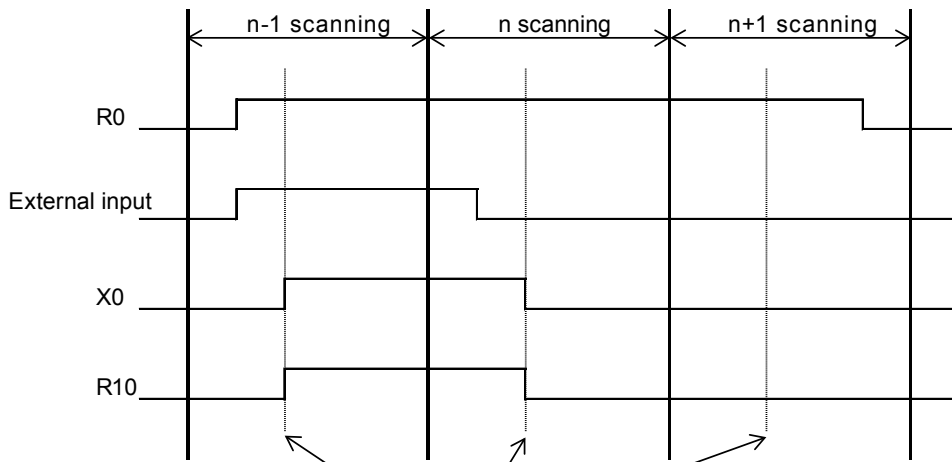

* CPU input time constant setting: None

Execute DAN X0

18.2.3 [DOR·DOR/] Direct OR / Direct OR NOT

DOR: read external input and connect normally open (NO) contacts (a contact) in parallel. As input refreshing is performed by taking contact as a unit, it is valid for controls with requirement for high-speed response.

DOR/: read external input and connect normally closed (NC) contacts (b contact) in parallel. As input refreshing is performed by taking contact as a unit, it is valid for controls with requirement for high-speed response.

■ Instruction format

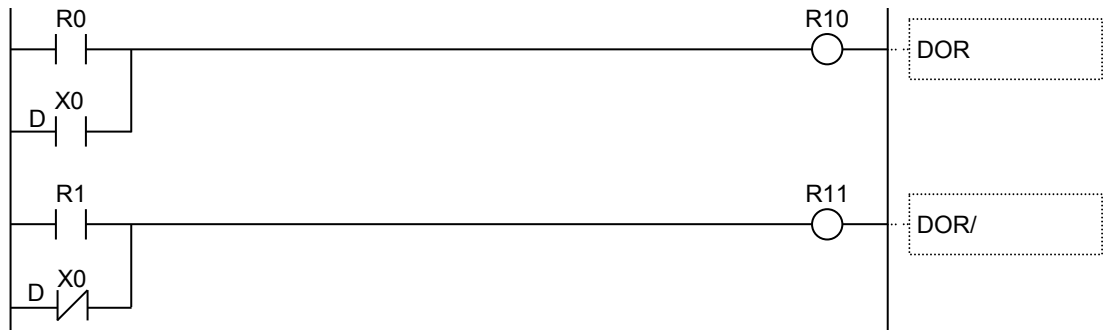

■ Type of relays that can be specified (unit: bit) (A: Available, -: Not available)

		X	Y	R	T	C	L	P	E	Index modifier
DOR	Normally open (NO) contacts connected in parallel	A	-	-	-	-	-	-	-	A
DOR/	Normally closed (NC) contacts connected in parallel	A	-	-	-	-	-	-	-	A

■ Operation description

- Read specified external input and reflect it to output contact, and then perform logic add operation with the current result calculated with contacts connected in parallel.

<Example> During the above procedure

- When R0 flag is ON or external input X0 flag is ON, R10 flag will be ON.
- When R1 flag is ON or and external input X0 flag is OFF, R11 flag will be ON.

■ Range that can be specified

Model	Device Range
FP-XH M8N control unit	X0-X7·X1100-X141F (Note)

(Note): When designating X1100-X141F, the input area of the motion control part is read and reflected.

■ Precautions for programs

- When the contact is out of the specified possible range, operation error may occur.
- When setting the time through main unit input time constant setting function of system register, the time constant will be invalid.

■ **Comparison of OR instruction and DOR instruction**

- DOR instruction is more suitable for requirement for high-speed response than OR instruction.

<For OR instruction>

● **Ladder diagram**



● **Time chart**

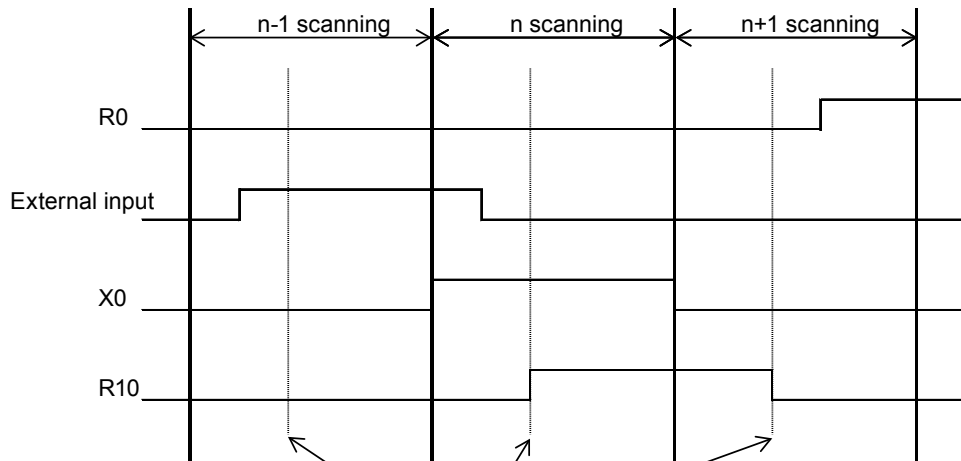

* CPU input time constant setting: None

Execute OR X0

<For DOR instruction>

● Ladder diagram



● Time chart

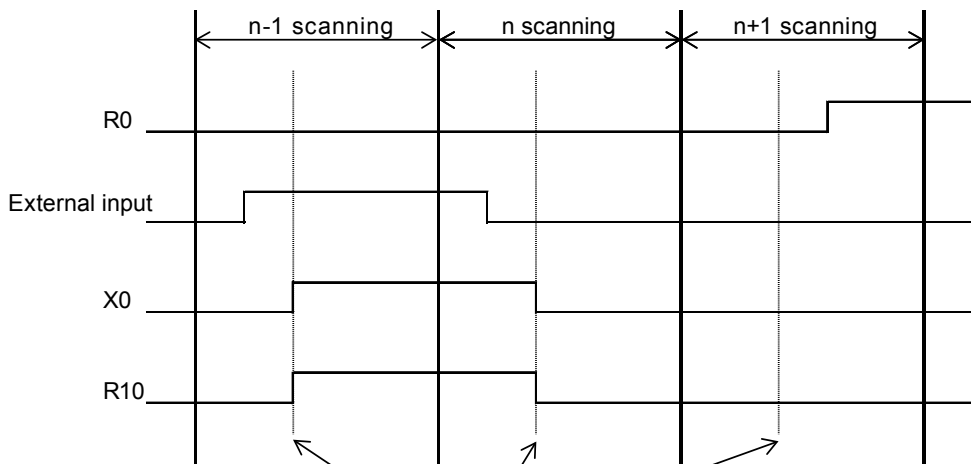

* CPU input time constant setting: None

Execute DOR X0

18.3 Direct Output Instruction

18.3.1 [DOT] Direct output

DOT: operate external output (ON/OFF). As input refreshing is performed by taking contact as a unit, it is valid for controls with requirement for high-speed response.

■ Instruction format

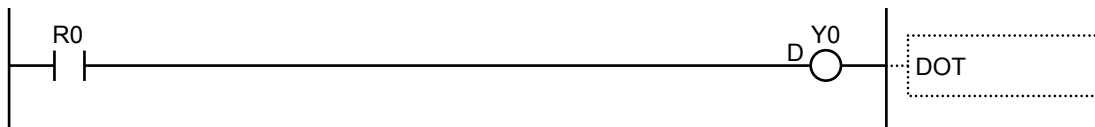

■ Type of relays that can be specified (unit: bit) (A: Available, -: Not available)

		X	Y	R	T	C	L	P	E	Index modifier
DOT	Coil outputting logic operation result	-	A	-	-	-	-	-	-	A

■ Operation description

- 「DOT」 Instruction, reflect operation result to specified output contact, external input flag will be On/OFF.

<Example> During the above procedure

- When R0 flag is ON, external output Y0 flag will be ON.
- When R0 flag is OFF, external output Y0 flag will be OFF.

■ Range that can be specified

Model	Device Range
FP-XH M8N control unit	Y0-Y7-Y1100-Y141F (Note)

(Note): When designating Y1100-Y141F, the input area of the motion control part is read and reflected.

■ Precautions for programs

- When the contact is out of the specified possible range, operation error may occur.
- A syntax error may occur if the same output coil is specified (dual output).

■ Comparison of OT instruction and DOT instruction

- DOT instruction is more suitable for requirement for high-speed response than OT instruction.

<For OT instruction>

● Ladder diagram



● Time chart

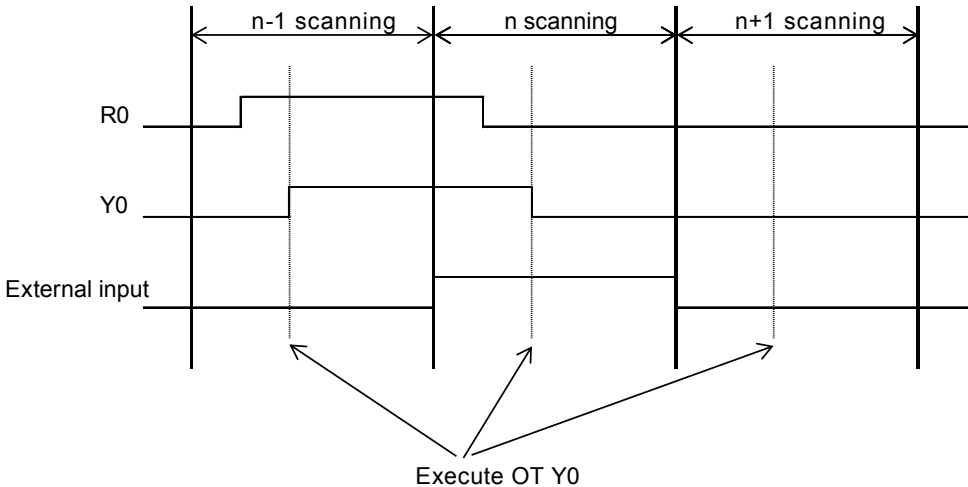

<For DOT instruction>

● Ladder diagram



● Time chart

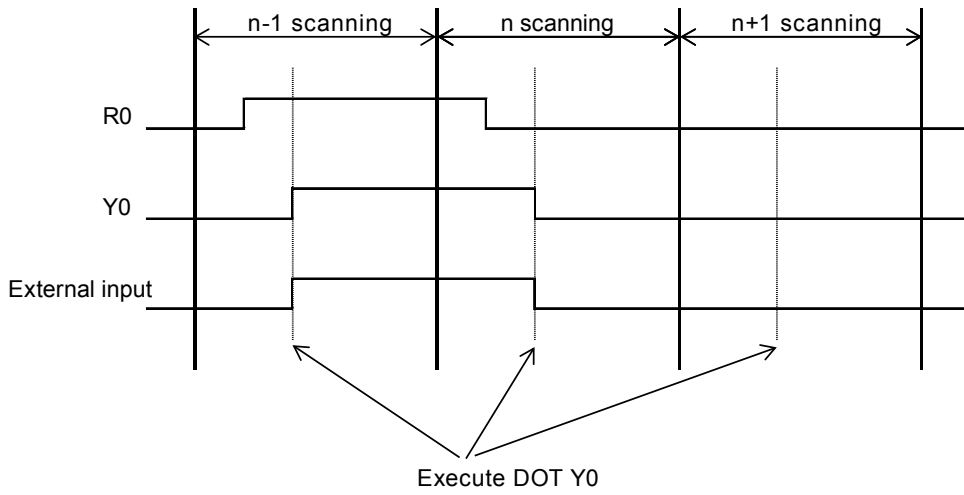

18.3.2 [DSET-DRST] Direct set / Direct reset

DSET: When execution condition is satisfied, external output flag will be ON. And the ON state will be held. As input refreshing is performed by taking contact as a unit, it is valid for controls with requirement for high-speed response.

DRST: When execution condition is satisfied, external output flag will be OFF. And the OFF state will be held. As input refreshing is performed by taking contact as a unit, it is valid for controls with requirement for high-speed response.

■ Instruction format

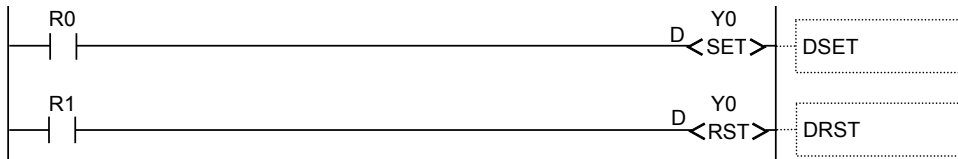

■ Type of relays that can be specified (unit: bit) (A: Available, -: Not available)

		X	Y	R	T	C	L	P	E	Index modifier
DSET	Output coil	-	A	-	-	-	-	-	-	A
DRST	Output coil	-	A	-	-	-	-	-	-	A

■ Operation description

- 「DSET」 Instruction, when execution condition is ON, the specified output contact flag will be ON and external output flag will be ON. Hold the ON state, regardless of the change of state of execution condition.
- 「DRST」 Instruction, when execution condition is ON, the specified output contact flag will be OFF and external output flag will be OFF. Hold the OFF state, regardless of the change of state of execution condition.
- 「DSET」「DRST」 Instruction can designate output on the same coil for many times. (No syntax error may occur even if total check is performed)

<Example> During the above procedure

- When R0 flag is ON, external output Y0 flag will be ON and the ON state will be held.
- When R1 flag is ON, external output Y0 flag will be OFF and the OFF state will be held.

■ Range that can be specified

Model	Device Range
FP-XH M8N control unit	Y0-Y7·Y1100-Y141F (Note)

(Note): When designating Y1100-Y141F, the input area of the motion control part is read and reflected.

■ Precautions for programs

- When the contact is out of the specified possible range, operation error may occur.
- The state of output end of DSET instruction will be held even if 「MC」 instruction is being executed.
- The output end of DSET instruction will be reset when switching from 「RUN mode」 to 「PROG mode」 or when the power is OFF, etc.

■ **Comparison of SET instruction and DSET instruction**

- DSET instruction is more suitable for requirement for high-speed response than SET instruction.

<For SET instruction>

● Ladder diagram

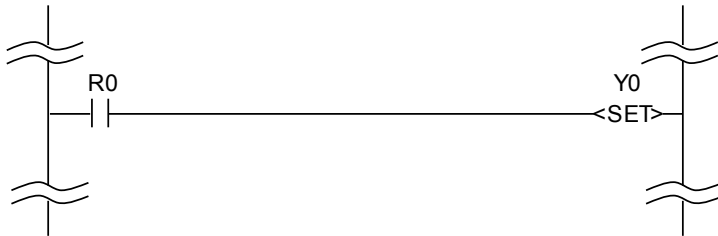

● Time chart

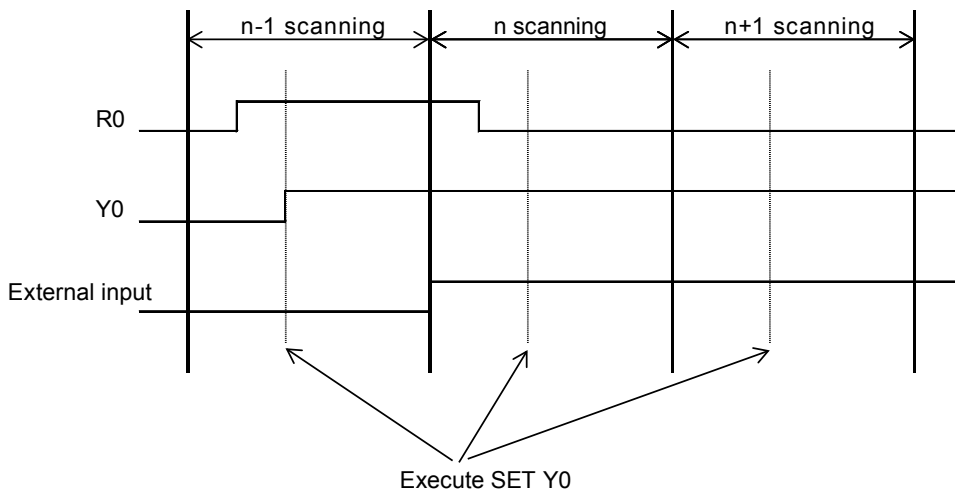

<For DSET instruction>

● Ladder diagram

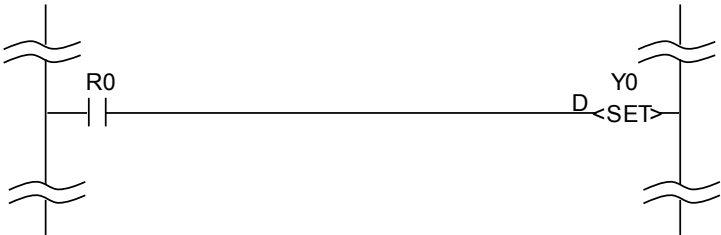

● Time chart

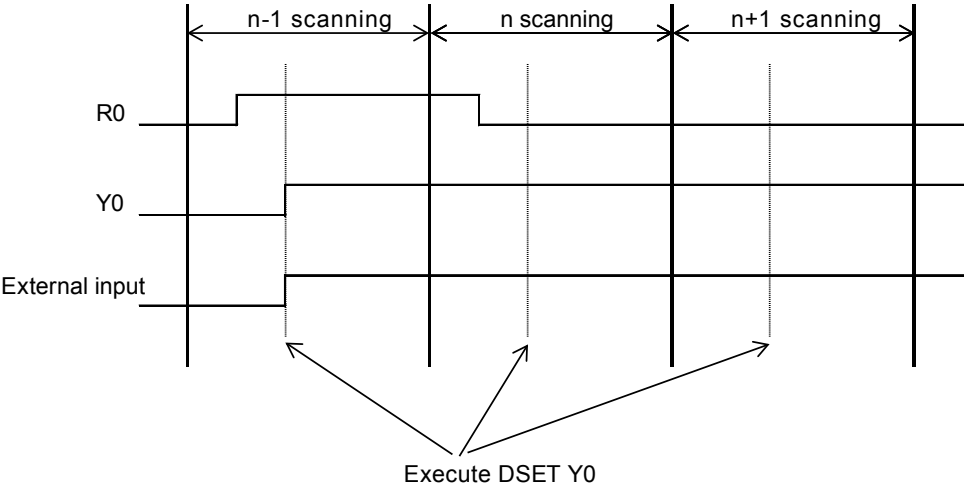

■ **Comparison of RST instruction and DRST instruction**

- DRST instruction is more suitable for requirement for high-speed response than RST instruction.

<For RST instruction>

● Ladder diagram



● Time chart

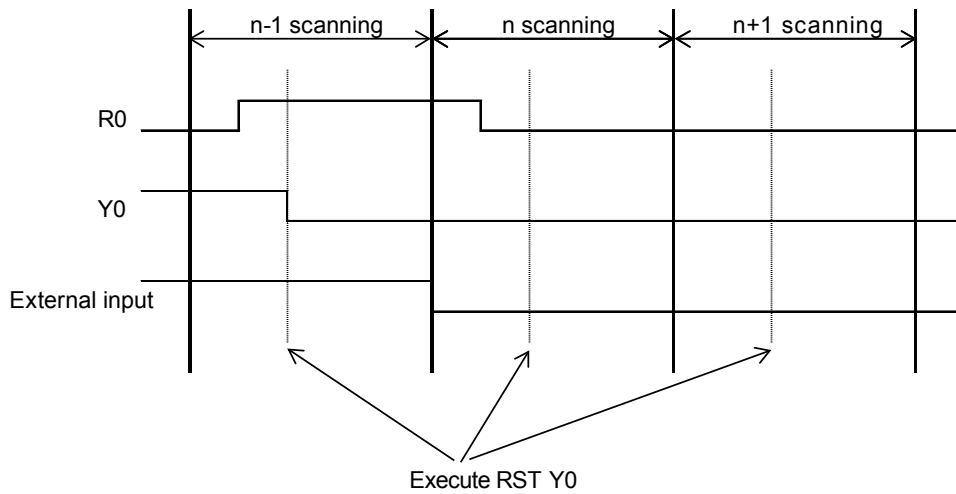

<For DOT instruction>

● Ladder diagram



● Time chart

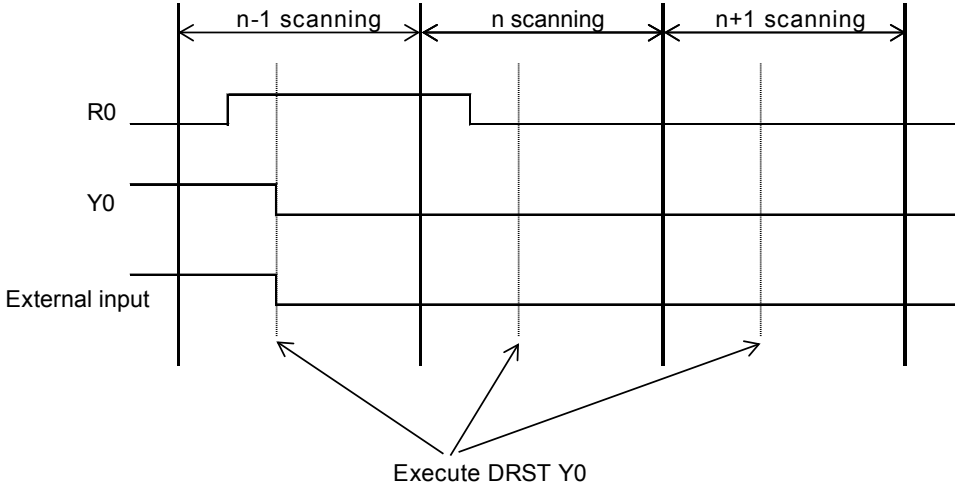

18.3.3 [DKP] Direct hold

DKP: By outputting with set/reset input, external input flag will be On/OFF and its state will be held.

■ Instruction Format

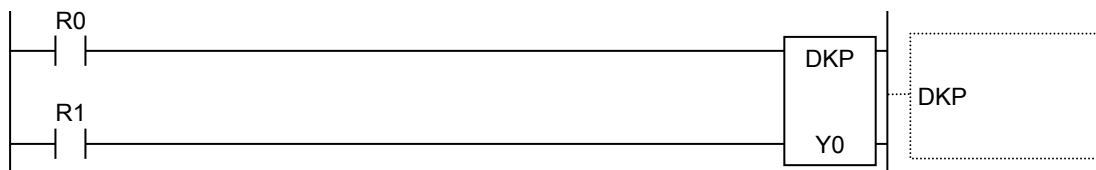

■ Type of relays that can be specified (unit: bit) (A: Available, -: Not available)

		X	Y	R	T	C	L	P	E	Index modifier
DKP	Output coil	-	A	-	-	-	-	-	-	-

■ Operation description

- When set input is ON, the specified coil output will be ON and external output flag will be ON. And its state will be held.
- When reset input is ON, the specified coil output will be OFF and external output flag will be OFF. And the holding state will be canceled.
- When the flag is held in the middle, this state will be held until the reset input flag is changed, regardless of ON/OFF state of set input.
- When set input and reset input is ON simultaneously, the reset input will be performed preferentially.

<Example> During the above procedure

- When R0 flag is ON, external output Y0 flag will be ON and the ON state will be held.
- When R1 flag is ON, external output Y0 flag will be OFF and the OFF state will be held.

■ Range that can be specified

Model	Device Range
FP-XH M8N control unit	Y0-Y7-Y1100-Y141F (Note)

(Note): When designating Y1100-Y141F, the input area of the motion control part is read and reflected.

■ Precautions for programs

- When the contact is out of the specified possible range, operation error may occur.
- Syntax error may occur if the same output coil is specified (dual output).
- The state of output end will be held even if 「MC」 instruction is being executed.
- The output end will be reset when switching from 「RUN mode」 to 「PROG mode」 or when the power is OFF, etc.

■ Comparison of KP instruction and DKP instruction

- DKP instruction is more suitable for requirement for high-speed response than KP instruction.

<For KP instruction >

●Ladder diagram

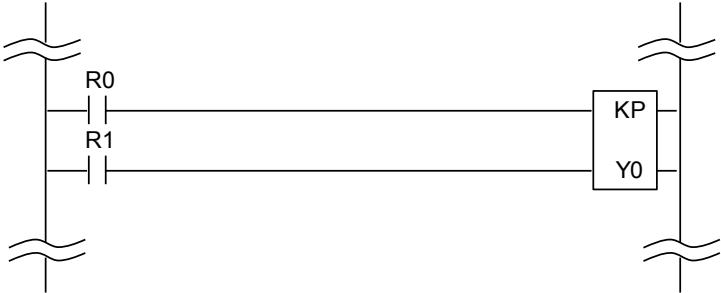

●Time chart

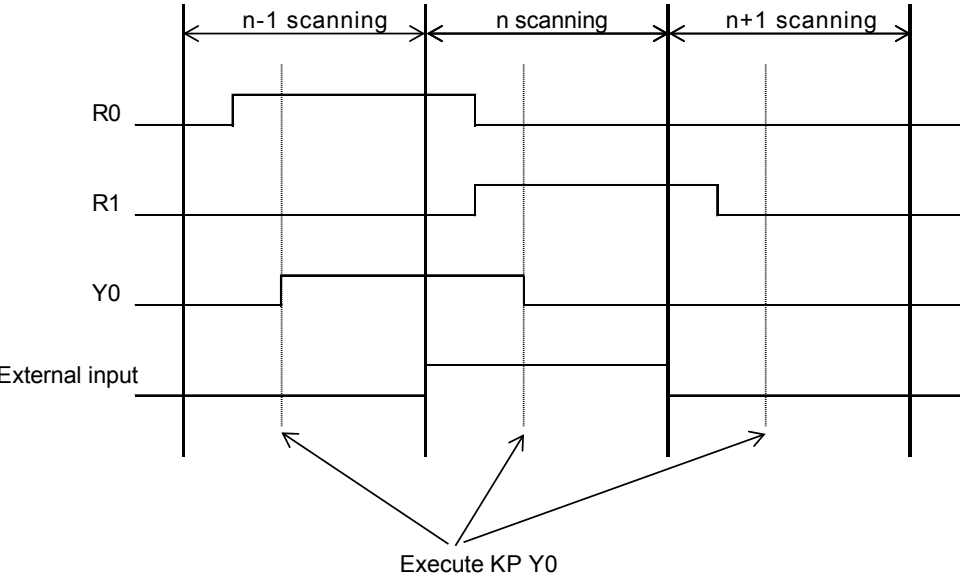

<For DKP instruction>

- Ladder diagram

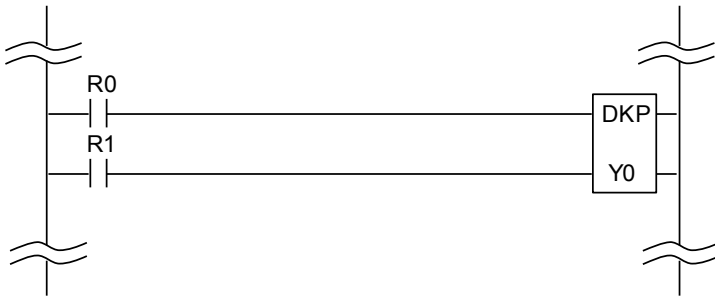

- Time chart

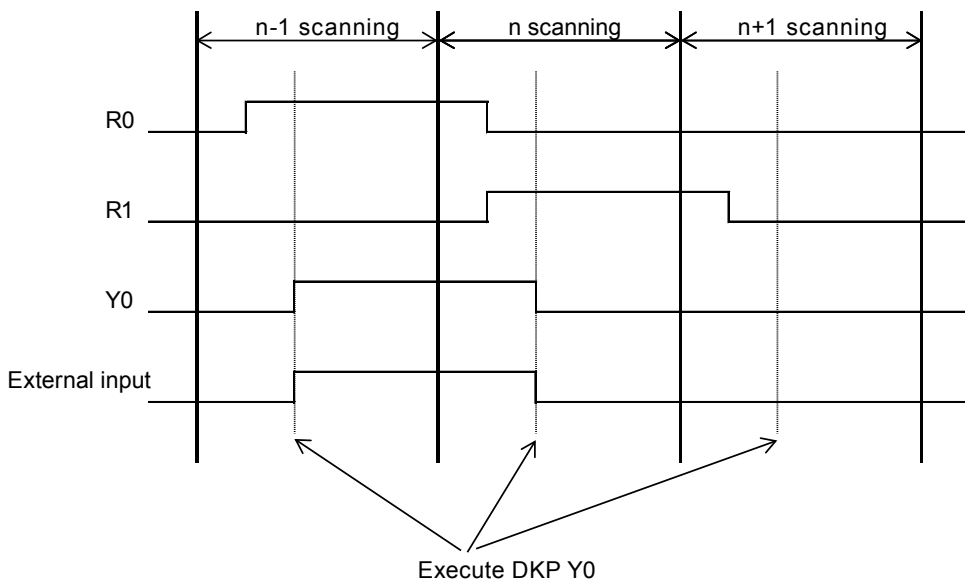

19

Error/Warning Annunciation Function

19.1 Errors and Warnings

19.1.1 Errors and Warnings

■ **Function of Error/Warning**

- Notify that error occurs in the setting and operation of motion control part.
- The difference between error and warning is as follows.

Error	When an error occurs, the running motor will stop. The motor stopped due to occurrence of error will not resume its operation before the error is cleared.
WARNING	Warning may occur when non-anomalous disorder of operation occurs. Operation can be executed after the warning, and the running motor will keep running.

■ **Relationship with self-diagnosis error.**

- when error or warning occurs, it will be detected as a self-diagnosis error (error code: position control operation error).
- Operation mode of control unit is set by using the system register No. 24 when position control operation error occurred. The default setting sets the operation to "continue", so the operation of motion control part is the one described in the table above. If "stop" is selected by system register No. 24, the motor will stop in case of error or warning.

19.1.2 Check and Clearing with Configurator PM7

It is possible to check and clear data on an axis-by-axis basis by selecting [Online] → [Data monitor] on the Configurator PM7 programming tool.

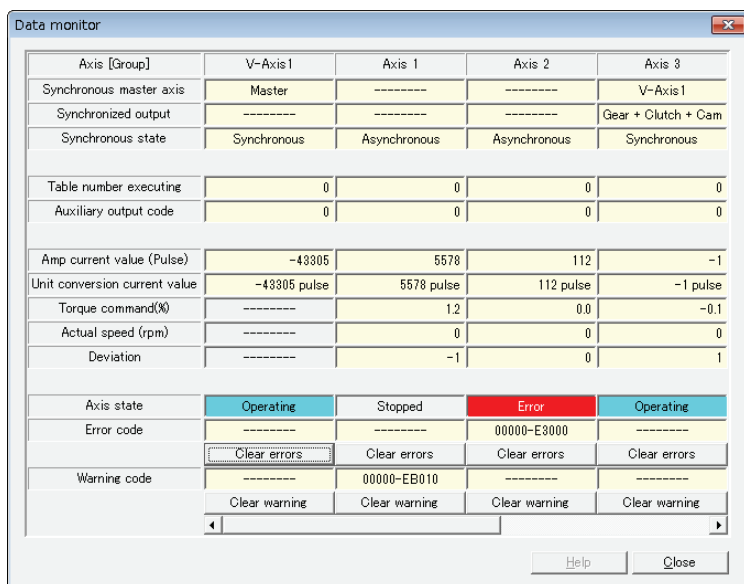

19.1.3 Check and Clearing with User Program

■ Confirmation of Error/Warning message

- The message is read via the special instruction PERED (Error/Warning obtained). When executing F388 PERRD instruction, in addition to error code and warning code, the code saved in buffer 1 will be read.

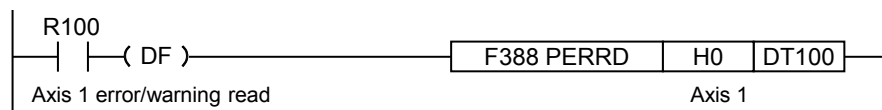

Error and warning codes are saved as follows.

DT100	Error code
DT101	Warning code

■ Clear of all axes is performed via UCLR instruction

- Error and warning occurred in the all axes of control unit can be cleared by executing the special instruction UCLR (Error/Warning cleared).



■ Clear for each axis via the I/O signal

- When the Error/Warning clear request flag assigned to I/O area is ON, the Error/Warning of each axis can be cleared individually. The following is the program for clearing the error.

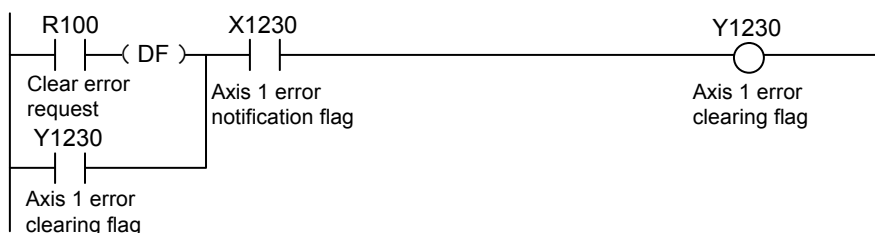

■ Allocation of I/O signals

Signal name	Axis 1	Axis 2	Axis 3	Axis 4	Axis 5	Axis 6	Axis 7 (virtual)	Axis 8 (virtual)
Error annunciation	X1230	X1231	X1232	X1233	X1234	X1235	X1236	X1237
Warning annunciation	X1240	X1241	X1242	X1243	X1244	X1245	X1246	X1247
Error clear request	Y1230	Y1231	Y1232	Y1233	Y1234	Y1235	Y1236	Y1237
Warning clear request	Y1240	Y1241	Y1242	Y1243	Y1244	Y1245	Y1246	Y1247

19.1.4 Error/Warning Log

Log area for saving Error/Warning code when Error/Warning occurs is reserved in the unit.

Error log	Up to 7 error codes can be saved in each axis
Warning log	Up to 7 warning codes can be saved in each axis

- In case of Error/Warning, the Error/Warning code will be saved in the log area of the axis where the error occurs.
- Only the newest Error/Warning code of each axis can be confirmed in the position control setting menu of programming tool.
- Please read the Error/Warning log of each axis from the Error/Warning log area saved in the positioning memory (common area).

Error log

H128~H137	Error log area of axis 1	H128	—
H138~H147	Error log area of axis 2	H129	No. of occurrences of errors
H148~H157	Error log area of axis 3	H12A~H12B	Error code annunciation buffer 1
H158~H167	Error log area of axis 4	H12C~H12D	Error code annunciation buffer 2
H168~H177	Error log area of axis 5	H12E~H12F	Error code annunciation buffer 3
H178~H187	Error log area of axis 6	H130~H131	Error code annunciation buffer 4
H188~H197	Error log area of (virtual) axis 7	H132~H133	Error code annunciation buffer 5
H198~H1A7	Error log area of (virtual) axis 8	H134~H135	Error code annunciation buffer 6
		H136~H137	Error code annunciation buffer 7

Warning log area

H1C0~H1CF	Warning log area of axis 1	H1C0	—
H1D0~H1DF	Warning log area of axis 2	H1C1	No. of occurrences of warnings
H1E0~H1EF	Warning log area of axis 3	H1C2~H1C3	Warning code annunciation buffer 1
H1F0~H1FF	Warning log area of axis 4	H1C4~H1C5	Warning code annunciation buffer 2
H200~H20F	Warning log area of axis 5	H1C6~H1C7	Warning code annunciation buffer 3
H210~H21F	Warning log area of axis 6	H1C8~H1C9	Warning code annunciation buffer 4
H220~H22F	Warning log area of (virtual) axis 7	H1CA~H1CB	Warning code annunciation buffer 5
H230~H23F	Warning log area of (virtual) axis 8	H1CC~H1CD	Warning code annunciation buffer 6
		H1CE~H1CF	Warning code annunciation buffer 7

Error/warning count	Save Error/Warning occurrence number.
Error/Warning annunciation buffer	Save Error/Warning code. The code saved in buffer 1 is always the newest one and the codes are saved in buffer 1⇒ buffer 2.....in the occurrence order of Error/Warning respectively.

■ Sample program

- Read Error count of axis-1 to DT100, and the example for reading Error code saved in Error code annunciation buffers 1 - 7 to 14 characters of DT101 - DT114 is as follows.
- Similarly, read Warning count of axis-1 to DT200, and the example for reading Warning code saved in Warning code annunciation buffers 1 - 7 to 14 characters of DT201 - DT214 is as follows.
- Read 2 characters for each Error code and Warning code.

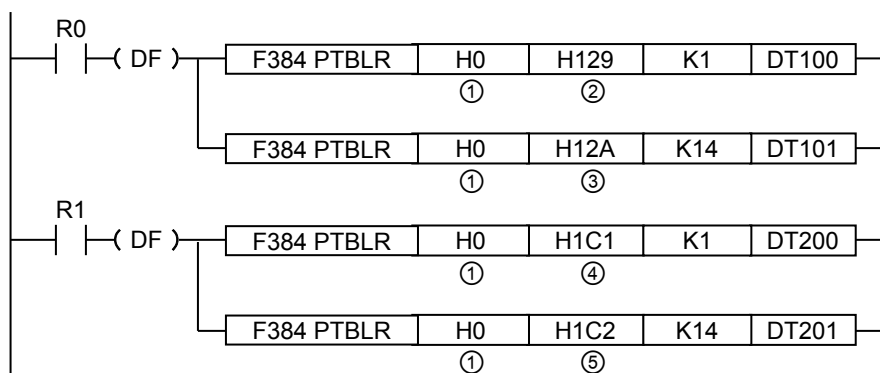

■ Code	■ Content specified by program	■ Value specified by program							
		Axis 1	Axis 2	Axis 3	Axis 4	Axis 5	Axis 6	Axis 7 (virtual)	Axis 8 (virtual)
①	Common area	H0							
②	No. of occurrences of errors	H129	H139	H149	H159	H169	H179	H189	H199
③	Starting address of error code annunciation buffer	H12A	H13A	H14A	H15A	H16A	H17A	H18A	H19A
④	No. of occurrences of warnings	H1C1	H1D1	H1E1	H1F1	H201	H211	H221	H231
⑤	Starting address of warning annunciation buffer	H1C2	H1D2	H1E2	H1F2	H202	H212	H222	H232

19.2 Change of Error Recovery Processing

19.2.1 Outline

Recovery methods after error occurred varies from state to state when the error occurs.

State when the error occurs	Description
Recoverable state (Yes)	<ul style="list-style-type: none">• The moving axis stops after the error occurs.• The control unit can recover the error at any time after the error occurs.
Unrecoverable state (No)	<ul style="list-style-type: none">• Error when severe abnormalities appeared in the system of control unit.• Reconnect the power in case of unrecoverable error.

19.3 Table of Error Codes

19.3.1 AMP Errors (0001H 0-)

- Alarms/errors occurred on the AMP side are output on the FP-XH M8N Control Unit side as error codes.
- The AMP errors differ depending on the types of AMP. For details of the processing for AMP errors, refer to the manual of servo amplifiers.
- When an AMP error occurs, the servomotor automatically becomes free. Execute the servo on request again after clearing the error.

■ How to read AMP error codes

- An AMP error is divided into a main code and sub code.
- The error codes stored in the error annunciation area of the FP-XH M8N Control Unit are hexadecimal 4-digit codes.
- For confirming error codes on the AMP, convert the hexadecimal codes to decimal codes.

Example) When the encoder communication error protection occurred;

Error code of this unit: 01 15 H

↓

Main code: 15 H, Sub code: 01 H

↓

Converts hexadecimal codes to decimal codes

Error code of the AMP

Main code: 21, Sub code: 1

■ AMP error code table [For A6N]

FP-XH M8N error code	A6N error no.		Description
	Main	Sub	
000BH	11	0	Control power supply undervoltage protection
000CH	12	0	Over-voltage protection
000DH	13	0	Main power supply undervoltage protection (between P to N)
010DH	13	1	Main power supply undervoltage protection (AC interception detection)
000EH	14	0	Over-current protection
010EH	14	1	IPM error protection
000FH	15	0	Over-heat protection
010FH	15	1	Encoder overheat error protection
0010H	16	0	Over-load protection
0110H	16	1	Torque saturation error protection
0012H	18	0	Over-regeneration load protection
0112H	18	1	Over-regeneration Tr error protection
0015H	21	0	Encoder communication disconnect error protection
0115H	21	1	Encoder communication error protection
0017H	23	0	Encoder communication data error protection
0018H	24	0	Position deviation excess protection
0118H	24	1	Speed deviation excess protection
0019H	25	0	Hybrid deviation excess error protection
001AH	26	0	Over-speed protection
011AH	26	1	2nd over-speed protection
011BH	27	1	Absolute clear protection
041BH	27	4	Command error protection 1
051BH	27	5	Command generation error protection
061BH	27	6	Operation command contention protection
071BH	27	7	Position information initialization error protection
001CH	28	0	Limit of pulsareplay error protection
011DH	29	1	Counter overflow protection 1
021DH	29	2	Counter overflow protection 2
001FH	31	0	Safety function error protection 1
021FH	31	2	Safety function error protection 2
0021H	33	0	I/F overlaps allocation error 1 protection
0121H	33	1	I/F overlaps allocation error 2 protection
0221H	33	2	I/F input function number error 1 protection
0321H	33	3	I/F input function number error 2 protection
0421H	33	4	I/F output function number error 1 protection
0521H	33	5	I/F output function number error 2 protection

(Note): Refer to the latest instruction manual and technical materials of the servo amplifier.

FP-XH M8N error code	A6N error no.		Description
	Main	Sub	
0821H	33	8	Latch input allocation error protection
0022H	34	0	Software limit protection
0024H	36	0	EEPROM parameter error protection
0124H	36	1	EEPROM parameter error protection
0025H	37	0	EEPROM check code error protection
0125H	37	1	EEPROM check code error protection
0225H	37	2	EEPROM check code error protection
0026H	38	0	Over-travel inhibit input protection 1
0126H	38	1	Over-travel inhibit input protection 2
0226H	38	2	Over-travel inhibit input protection 3
0028H	40	0	Absolute system down error protection
0029H	41	0	Absolute counter over error protection
002BH	43	0	Encoder initialization error protection
002CH	44	0	Single turn counter error protection
002DH	45	0	Multi-turn counter error protection
0030H	48	0	Encoder Z-phase error protection
0031H	49	0	Encoder CS signal error protection
0032H	50	0	External scale connection error protection
0132H	50	1	External scale communication data error protection
0033H	51	0	External scale ST error protection 0
0133H	51	1	External scale ST error protection 1
0233H	51	2	External scale ST error protection 2
0333H	51	3	External scale ST error protection 3
0433H	51	4	External scale ST error protection 4
0533H	51	5	External scale ST error protection 5
0037H	55	0	Phase A connection error protection
0137H	55	1	Phase B connection error protection
0237H	55	2	Phase Z connection error protection
0052H	82	0	RTEX node addressing error protection
0053H	83	0	RTEX communication error protection 1
0153H	83	1	RTEX communication error protection 2
0054H	84	0	RTEX time out error protection
0354H	84	3	RTEX sync and initialization error protection
0554H	84	5	RTEX communication cycle error protection
0056H	86	0	RTEX cyclic data error protection 1
0156H	86	1	RTEX cyclic data error protection 2

(Note): Refer to the latest instruction manual and technical materials of the servo amplifier.

Error/Warning Annunciation Function

FP-XH M8N error code	A6N error no.		Description
	Main	Sub	
0256H	86	2	RTEX update counter error protection
0057H	87	0	Compulsory alarm input protection
025AH	90	2	Multi-axis synchronization establishment error protection
015BH	91	1	RTEX command error protection
005CH	92	0	Encoder data recovery error protection
015CH	92	1	External scale data recovery error protection
035CH	92	3	Multi-turn data upper-limit value disagreement error protection
005DH	93	0	Parameter setting error protection 1
025DH	93	2	Parameter setting error protection 2
035DH	93	3	External scale connection error protection
055DH	93	5	Parameter setting error protection 4
085DH	93	8	Parameter setting error protection 6
025EH	94	2	Home position return error protection
035EH	94	3	Home position return error protection 2
005FH	95	0	Motor automatic recognition error protection
015FH	95	1	Motor automatic recognition error protection
025FH	95	2	Motor automatic recognition error protection
035FH	95	3	Motor automatic recognition error protection
045FH	95	4	Motor automatic recognition error protection
0260H	96	2	Control unit error protection 1
0360H	96	3	Control unit error protection 2
0460H	96	4	Control unit error protection 3
0560H	96	5	Control unit error protection 4
0660H	96	6	Control unit error protection 5
0760H	96	7	Control unit error protection 6
0162H	98	1	RTEX hardware error protection 1
0262H	98	2	RTEX hardware error protection 2
0362H	98	3	RTEX hardware error protection 3
-	Other numbers		Other error protections

(Note): Refer to the latest instruction manual and technical materials of the servo amplifier.

■ AMP error code table [For A5N]

FP-XH M8N error code	A5N error no.		Description
	Main	Sub	
000BH	11	0	Control power supply undervoltage protection
000CH	12	0	Over-voltage protection
000DH	13	0	Main power supply undervoltage protection (between P to N)
010DH	13	1	Main power supply undervoltage protection (AC interception detection)
000EH	14	0	Over-current protection
010EH	14	1	IPM error protection
000FH	15	0	Over-heat protection
0010H	16	0	Over-load protection
0110H	16	1	Torque saturation error protection
0012H	18	0	Over-regeneration load protection
0112H	18	1	Over-regeneration Tr error protection
0015H	21	0	Encoder Communication disconnect error protection
0115H	21	1	Encoder Communication error protection
0017H	23	0	Encoder communication data error protection
0018H	24	0	Position deviation excess protection
0118H	24	1	Speed deviation excess protection
0019H	25	0	Hybrid deviation excess error protection
001AH	26	0	Over-speed protection
011AH	26	1	2nd over-speed protection
011BH	27	1	Absolute clear protection
041BH	27	4	Command error protection 1
051BH	27	5	Command generation error protection
061BH	27	6	Operation command contention protection
071BH	27	7	Position information initialization error protection
001CH	28	0	Limit of pulse replay error protection
011DH	29	1	Deviation counter overflow protection 1
021DH	29	2	Deviation counter overflow protection 2
001EH	30	0	Safety detection [Only special product supports this feature.]
0021H	33	0	I/F input duplicated allocation error 1 protection
0121H	33	1	I/F input duplicated allocation error 2 protection
0221H	33	2	I/F input function number error 1 protection
0321H	33	3	I/F input function number error 2 protection
0421H	33	4	I/F output function number error 1 protection
0521H	33	5	I/F output function number error 2 protection
0821H	33	8	Latch input allocation error protection
0022H	34	0	Software limit protection

(Note): Refer to the latest instruction manual and technical materials of the servo amplifier.

Error/Warning Annunciation Function

FP-XH M8N error code	A5N error no.		Description
	Main	Sub	
0024H	36	0	EEPROM parameter error protection
0124H	36	1	EEPROM parameter error protection
0224H	36	2	EEPROM parameter error protection
0025H	37	0	EEPROM check code error protection
0125H	37	1	EEPROM check code error protection
0225H	37	2	EEPROM check code error protection
0026H	38	0	Over-travel inhibit input protection 1
0126H	38	1	Over-travel inhibit input protection 2
0226H	38	2	Over-travel inhibit input protection 3
0028H	40	0	Absolute system down error protection
0029H	41	0	Absolute counter over error protection
002AH	42	0	Absolute over-speed error protection
002BH	43	0	Incremental encoder initialization error protection
002CH	44	0	<ul style="list-style-type: none"> · For Absolute Absolute single turn counter error protection · For Incremental Incremental single turn counter error protection
002DH	45	0	<ul style="list-style-type: none"> · For Absolute Absolute multi-turn counter error protection · For Incremental Incremental multi-turn counter error protection
002FH	47	0	Absolute status error protection
0030H	48	0	Incremental encoder Z-phase error protection
0031H	49	0	Incremental encoder CS signal error protection
0032H	50	0	External scale connection error protection
0132H	50	1	External scale communication error protection
0033H	51	0	External scale status 0 error protection
0133H	51	1	External scale status 1 error protection
0233H	51	2	External scale status 2 error protection
0333H	51	3	External scale status 3 error protection
0433H	51	4	External scale status 4 error protection
0533H	51	5	External scale status 5 error protection
0037H	55	0	A-phase connection error protection
0137H	55	1	B-phase connection error protection
0237H	55	2	Z-phase connection error protection
0052H	82	0	RTEX node addressing error protection
0053H	83	0	RTEX communication error protection 1
0153H	83	1	RTEX communication error protection 2
0054H	84	0	RTEX time out error protection
0354H	84	3	RTEX sync and initialization error protection
0554H	84	5	RTEX communication cycle error protection

(Note): Refer to the latest instruction manual and technical materials of the servo amplifier.

FP-XH M8N error code	A5N error no.		Description
	Main	Sub	
0056H	86	0	RTEX cyclic data error protection 1
0156H	86	1	RTEX cyclic data error protection 2
0256H	86	2	RTEX update counter error protection
0057H	87	0	Compulsory alarm input protection
025AH	90	2	Multi-axis synchronization establishment error protection
015BH	91	1	RTEX command error protection
005CH	92	0	Encoder data recovery error protection
015CH	92	1	External scale data recovery error protection
005DH	93	0	Parameter setting error protection 1
025DH	93	2	Parameter setting error protection 2
035DH	93	3	External scale connection error protection
055DH	93	5	Parameter setting error protection 4
025EH	94	2	Home position return error protection
005FH	95	0	Motor automatic recognition error protection
015FH	95	1	Motor automatic recognition error protection
025FH	95	2	Motor automatic recognition error protection
035FH	95	3	Motor automatic recognition error protection
045FH	95	4	Motor automatic recognition error protection
0162H	98	1	RTEX hardware error protection 1
0262H	98	2	RTEX hardware error protection 2
0362H	98	3	RTEX hardware error protection 3
-	Other numbers		Other error protections

(Note): Refer to the latest instruction manual and technical materials of the servo amplifier.

19.3.2 System Errors (1000H -)

The followings are errors occurred due to internal abnormalities of the unit. The system error is defined as the error that has a fatal effect on the system. Except for some items, reconnecting the power is necessary for the recovery of system error.

Code	Name	Description	Object	Recovery	Measures
1000H	System crash	System crash	All axes	×	Reconnect the power. If this error continues, please contact our company.
1001H	Hardware error	Error occurred during the hardware test with the power ON	All axes	×	
1002H	Unit error	Some errors occurred during internal processing	All axes	×	
1003H	System processing error	System processing error caused by some reasons	All axes	○	Check the settings. If this error continues while there are no abnormal settings, please contact our company.
1015H	System start error	Reading positioning setting data failed at the time of the system startup.	All axes	×	Turn off the power supply and turn it on again. If an error occurs repeatedly, consult your Panasonic representative.
1020H	Tools running Abnormal completion	Error occurs in the communication with the computer when performing tools running via the position control setting menu of programming tool.	All axes	○	Confirm the cable connection between computer and PLC. Restart the computer.
1030H	Control unit error	ALARM occurs in control unit	All axes	×	Confirm the state of the control unit. Reconnect the power.
1031H	Control unit Abnormal operation mode	Switch the control unit to PROG mode and the operation stops	All axes	○	Confirm the state of the control unit. Set the control unit as RUN mode.

19.3.3 AMP Communication Errors (2000H -)

These are the errors occurred in the communication between FP-XH M8N Control Unit and AMP.

Code	Name	Description	Object	Recovery	Measures
2000H	AMP communication error	A communication error occurred after the network communication has been established.	All axes	×	<ul style="list-style-type: none"> • Check the power supply of the AMP is on. • Check the communication pathway. Carefully check the connector failure and breaking of the communication cable. Also, check if any excessive noise is caused in the usage environment. • If the error occurred repeatedly, please contact us.
2001H	AMP data acquisition error	Failed in the data acquisition of each AMP.	Each axis	○	<ul style="list-style-type: none"> • Check the status of the AMP that the error occurred.
2002H	AMP parameter error	The communication parameters of each AMP are incorrect.	Each axis	○	<ul style="list-style-type: none"> • Check the communication pathway. Carefully check the connector failure and breaking of the communication cable. Also, check if any excessive noise is caused in the usage environment. • If the error occurred repeatedly, please contact us.
2003H	Network communication timeout	Time-out occurred in communication between the FP-XH M8N Control Unit and AMP, and communication was cut off.	Each axis	○	<ul style="list-style-type: none"> • Check the state of the AMP. (As information on the AMP cannot be obtained when communication is cut off, an error on the AMP may not be obtained.) • Check the communication cable.
2004H	AMP parameter control error	A communication error occurred during an AMP parameter operation (read, write, save or reset).	Each axis	○	<ul style="list-style-type: none"> • Check the state of the AMP. • Check that the control mode of the AMP is correctly set. (The speed control mode and torque control mode cannot be used.)
2010H	Excessive no. of AMP connections	The number of the AMPs connected to the network exceeded the limit (maximum No. of axes) of the unit.	All axes	×	<ul style="list-style-type: none"> • After checking the connection and settings of the AMP, turn off the power supply and turn it on again. • If the error occurred repeatedly, please contact us. • When using the virtual axes, set the unit numbers of AMPs as follows; when using one virtual axis: 1-7 when using two virtual axes: 1-6
2020H	AMP node duplication	The AMPs with the same unit number exist in the network.	All axes	×	
2021H	Virtual axis duplication error	The AMP with the following unit number is connected although virtual axes are used. When using one virtual axis: Unit no. 8 When using two virtual axes: Unit nos. 7 and 8	All axes	×	
2030H	AMP node number setting error	The AMP with a node number other than the numbers below exists. 1-8	All axes	×	
2040H	AMP reset failure	An error occurred in the AMP reset operation and the system stopped.	All axes	×	<ul style="list-style-type: none"> • Turn off the power supply to the system and turn it on again.
2050H	AMP connection error	A4N and A6N/A5N are both used for the connected AMP.	All axes	×	<ul style="list-style-type: none"> • Check the configuration of connected AMPs so that A4N and A6N/A5N are not mixed.

19.3.4 Axis Operation Errors (3000H -)

The followings are errors occurred when executing various of operations

Code	Name	Description	Object	Recovery	Measures
3000H	Not servo ready	The axis that servo is not locked was started.	Each axis	○	Confirm the servo is locked while each axis is operating
3001H	Servo off detection in operation	The servo became off during the operation being processed.	Each axis	○	- Turn off the servo on input when the busy signal for the target axis is not on. - Check the state of the AMP.
3005H	Main power supply OFF error	The servo on was requested when the main power supply of the AMP was off.	Each axis	○	- Turn the servo on after the main power supply has been turned on. - Check the voltage of the main power supply.
3010H	Limit + signal detection	The input on the positive side of the limit has turned ON.	Each axis	○	Move the motor into the range of the limit by an appropriate mode, such as JOG operation. Check the limit signal is correct.
3011H	Limit – signal detection	The input on the negative side of the limit has turned ON.	Each axis	○	
3012H	Limit signal error	Both inputs on the positive and negative sides of the limit have turned ON.	Each axis	○	Check the status of the limit signal.
3020H	Software limit (positive side) detection	The movement amount of the motor has exceeded the upper limit of the software limit.	Each axis	○	Move the motor into the range of the software limit by an appropriate mode, such as JOG operation. Check the set values of the software limit.
3021H	Software limit (negative side) detection	The movement amount of the motor has exceeded the lower limit of the software limit.	Each axis	○	
3025H	Command speed operation error 1	The internal operation of command speed failed due to overflow.	Each axis	○	Lower the set speed. Check the settings of the pulse number per rotation and movement amount per rotation.
3026H	Command speed operation error 2		Each axis	○	
3027H	Command speed operation error 3		Each axis	○	
3030H	Axis operation error	An error has occurred in the operation processing of each axis due to some reason.	Each axis	○	Check the set values and parameters for the positioning unit. If an error occurs repeatedly with the correct set values, consult your Panasonic representative.
3031H	Operation abnormal end	An error has occurred in the operation processing of each axis due to some reason.	Each axis All axes	○	If an error occurs repeatedly, consult your Panasonic representative.
3032H	Axis group operation error	Axis group settings are changed while the positioning unit is in operation or a stop request is being made. Axis group settings are outside the range.	Each axis	○	Changing the axis group should be performed when the axes are not in operation. Do not make a stop request, either. Check the axis group settings.
3033H	Interpolation operation error	The operation has stopped due to an error in another interpolation axis during interpolation.	Each axis	○	Check the set values for positioning data on interpolation. If an error occurs repeatedly with the correct set values, consult your Panasonic representative.

Code	Name	Description	Object	Recovery	Measures
3034H	Axis group not settable (In pulser operation)	The axis group settings are changed while the positioning unit is in pulser operation.	Each axis	○	Changing the axis group should be performed when the pulser operation enabled signal is OFF.
3035H	Positioning movement amount error	The positioning movement amount has exceeded the upper or lower limit.	Each axis	○	Check the set value.
3040H	Synchronous operation group error	The synchronous group is changed while the positioning unit is in synchronous operation or a stop request is being made. The settings of axis groups are outside the range. An error has occurred during a home return while the positioning unit is in synchronous operation.	Each axis	○	Changing the synchronous group should be performed when the busy signal for the axes to be synchronized is OFF. It should be performed when various stop request signals (system stop, emergency stop, deceleration stop) are OFF.
3042H	Synchronous operation home return error	The home return processing is executed in synchronous operation.	Each axis	○	When performing the home return processing, cancel the synchronous control.
3043H	Synchronous operation error	The operation has stopped as an error occurred on another axis while the positioning unit is in synchronous operation.	Each axis	○	Check the unit setting of the stopped axis. If an error occurs repeatedly with the correct set values, consult your Panasonic representative.
3044H	Synchronous operation not settable (In pulser operation)	The setting of the synchronous operation was changed while the positioning unit is in pulser operation.	Each axis	○	Changing the setting of the synchronous operation should be performed when the pulser operation enabled signal is OFF.
3045H	Synchronous axis difference check error	The difference between the movement amounts of the target axes under synchronous control exceeded the specified difference.	Each axis	○	Check the operation of the target axes for the synchronous operation.
3050H	Torque judgment error	The torque value exceeds the setting upper and lower limit values. This error occurs when setting - torque judgment to "Available" - annunciation method to "Error"	Each axis	○	<ul style="list-style-type: none"> • Design the system within the range that the torque of the motor does not exceed the judgment value. • Check the torque judgment value.
3051H	Actual speed judgment value error	The actual speed exceeds the setting upper and lower limit values. This error occurs when setting - actual speed judgment to "Available" - annunciation method to "Error"	Each axis	○	<ul style="list-style-type: none"> • Design the system within the range that the actual speed of the motor does not exceed the judgment value. • Check the actual speed judgment value.
3060H	Home return not executable error	The home return could not be executed as AMP parameter settings and signal input were not correct. This error occurs when using A6N/A5N as AMP.	Each axis	○	Check the parameters of AMP and signal inputs.

19.3.5 Set Value Errors (4000H -)

The following errors occur to various set values made in the positioning setting menu of the programming tool and ladder programs.

Code	Name	Description	Object	Recovery	Measures
4000H	Axis group setting error	The axis group setting is abnormal. When using the virtual axes, the virtual axes are not registered in the independent axis area of the axis group.	Each axis	○	Check settings of the axis group and individual axis as follows. - The same axis no. is registered in multiple groups. - More than 4 axes are set in the same group. - The axis group comprises only 1 axis. - The virtual axes are not registered in the independent axis area of the axis group.
4001H	Virtual axis setting error	The virtual axis usage setting (number of virtual axes) is incorrect.	All axes	○	Check the setting.
4002H	Unit setting error	The unit system for the axis setting is out of the range.	Each axis	○	Check if the unit is one of the followings. pulse, μm , inch, degree
4004H	Pulse number error per rotation	The pulse number is out of the range.	Each axis	○	Check the set value. If the set value is out of the range, reduce it by the following formula.
4005H	Movement amount error per rotation	The movement amount is out of the range.	Each axis	○	(Pulse number per rotation) / (Movement amount per rotation)
4010H	Software limit setting error	The upper or lower limit value of software limit is out of the range.	Each axis	○	Check the set value. If an error occurs repeatedly with the correct set values, consult your Panasonic representative.
4020H	Limit stop deceleration time error	The limit stop deceleration time is out of the range.	Each axis	○	
4021H	Error stop deceleration time error	The error stop deceleration time is out of the range.	Each axis	○	
4022H	Emergency stop deceleration time error	The emergency stop deceleration time is out of the range.	Each axis	○	
4028H	Auxiliary output setting error	The settings of auxiliary output are not correct. A mode other than With mode or Delay mode for the auxiliary output mode has been set. The auxiliary output delay ratio while the positioning unit is in Delay mode is not 0 to 100 (%).	Each axis	○	

Code	Name	Description	Object	Recovery	Measures
4030H	Synchronous group setting error	<p>The same axis has been set for the synchronous groups 1 and 2.</p> <p>Either master axis or slave axis has not been set.</p> <p>Multiple axes have been set for the master or slave axis.</p> <p>The same axis has been set for the master and slave axes.</p> <p>The slave axis has been set to the interpolation group.</p>	Each axis	○	<p>Check the set value.</p> <p>If an error occurs repeatedly with the correct set values, consult your Panasonic representative.</p>
4031H	Synchronous operation mode setting error	Operation settings for the synchronous operation differential check function are incorrect.	Each axis	○	
4041H	Completion width error	The completion width is out of the range.	Each axis	○	<p>Check the set value.</p> <p>If the error occurs repeatedly with the correct set values, please contact us.</p>
4042H	Pulsar setting error	<p>The pulsar input mode is incorrect.</p> <p>The pulsar operation method is incorrect.</p> <p>The maximum speed for the pulsar operation is incorrect.</p>	Each axis	○	<p>Check the set value.</p> <p>If the error occurs repeatedly with the correct set values, please contact us.</p>
4043H	Pulsar disabled error	The pulse input application of the axis which the upsar input is enabled is not set to pulsar.	Each axis	○	<p>Check the pulse input application.</p> <p>When using the pulsar, set the input application to "Pulsar".</p>
4044H	Speed factor error	The setting of the speed factor is out of the range.	Each axis	○	<p>Check the set value.</p> <p>If an error occurs repeatedly with the correct set values, consult your Panasonic representative.</p>
4080H	JOG positioning acceleration/deceleration method error	The acceleration/ deceleration method of the JOG positioning is out of the range.	Each axis	○	
4081H	JOG positioning acceleration time error	The acceleration time of the JOG positioning is out of the range.	Each axis	○	
4082H	JOG positioning deceleration time error	The deceleration time of the JOG positioning is out of the range.	Each axis	○	

Error/Warning Annunciation Function

Code	Name	Description	Object	Recovery	Measures
4083H	JOG positioning target speed error	The target speed of the JOG positioning is out of the range.	Each axis	○	<p>Check the set value.</p> <p>If an error occurs repeatedly with the correct set values, consult your Panasonic representative.</p>
4102H	Home return target speed error	The target speed of the home return is out of the range.	Each axis	○	
4105H	Home return acceleration time error	The acceleration time of the home return is out of the range.	Each axis	○	
4106H	Home return deceleration time error	The deceleration time of the home return is out of the range.	Each axis	○	
4107H	Home return setting code error	The home return setting code is incorrect.	Each axis	○	
4110H	Home return creep speed error	The creep speed of the home return is out of the range.	Each axis	○	
4111H	Home return returning direction error	The moving direction of the home return is incorrect	Each axis	○	
4112H	Home return limit error	The limit switch is disabled. (It occurs when the home return method is set to the limit method 1 or 2.)	Each axis	○	
4115H	Home return stop-on-contact torque value error	The home return stop-on-contact torque value is out of the range. (It occurs when the home return method is set to the stop-on-contact method 1 or 2.)	Each axis	○	
4116H	Home return Stop-on-contact judgment time error	The home return stop-on-contact judgment time is out of the range. (It occurs when the home return method is set to the stop-on-contact method 1 or 2.)	Each axis	○	
4120H	Coordinate origin error	The coordinate origin is out of the range.	Each axis	○	
4201H	JOG operation target speed error	The target speed of the JOG operation is out of the range.	Each axis	○	

Code	Name	Description	Object	Recovery	Measures
4203H	JOG operation acceleration/deceleration method error	The acceleration/deceleration method of the JOG operation is incorrect.	Each axis	○	Check the set value. If an error occurs repeatedly with the correct set values, consult your Panasonic representative.
4204H	JOG operation acceleration time error	The acceleration time of the JOG operation is out of the range.	Each axis	○	
4205H	JOG operation deceleration time error	The deceleration time of the JOG operation is out of the range.	Each axis	○	
4250H	Current value update error	The set value of the current value update is out of the range.	Each axis	○	
4251H	Realtime torque limit value error	The specified realtime torque value is out of the range.	Each axis	○	
4301H	Absolute/incremental setting error	A value other than the absolute/increment is set for the control method.	Each axis	○	
4302H	Dwell time error	The set value of the dwell time is out of the range.	Each axis	○	
4303H	Positioning starting table No. error	The specified table number is 0, or it exceeds the maximum table number.	Each axis	○	
4304H	Table setting error	The last table of the positioning setting tables is not the E point.	Each axis	○	
4400H	Positioning movement amount setting error	The movement amount of the positioning operation is out of the range.	Each axis	○	
4401H	Positioning acceleration/deceleration method error	The acceleration/deceleration method of the positioning operation is incorrect.	Each axis	○	
4402H	Positioning acceleration time error	The acceleration time of the positioning operation is out of the range.	Each axis	○	
4404H	Positioning target speed error	The target speed of the positioning operation is out of the range.	Each axis	○	
4500H	Interpolation type error	The setting of the interpolation type is incorrect.	Each axis	○	
4504H	Circular interpolation not executable	The parameter of the circular interpolation (such as center point or pass point) is incorrect.	Each axis	○	
4505H	Spiral interpolation not executable	The error occurred while the positioning unit is in spiral interpolation operation as the set value is incorrect.	Each axis	○	
4510H	Positioning speed change speed error	The position control speed change is out of the range.	Each axis	○	
4520H	Positioning movement amount change error	The positioning speed movement amount change is out of the range.	Each axis	○	
4600H	Pulse input setting error	The pulse input settings are incorrect.	Each axis	○	
4605H	Pulse count value change setting error	The set pulse count change value is out of the range.	Each axis	○	

19.3.6 Setting value errors of synchronous parameters (5000H -)

■ Synchronous parameters: Common errors (5000H -)

Code	Name	Description	Object	Recovery	Measures
5000H	Synchronous master setting value error	The setting for the synchronous master axis is incorrect. → Setting error (Value is incorrect.) → Own axis setting	Each axis	○	Check the set value. If the error occurs repeatedly with the correct set values, consult your Panasonic representative.
5001H	Synchronous master pulse input application error	The pulse input other than "High-speed counter" application was selected when setting the synchronous master axis to pulse input.	Each axis	○	
5002H	Synchronous setting disable error	The synchronous setting request was made in the following axis setting . - Its own axis (slave axis) is set as the master of another axis. - The master axis is set as the slave axis of another axis. - Its own axis (slave axis) belongs to the interpolation group.	Each axis	○	
5006H	Synchronous slave single deceleration stop deceleration time	The setting for the synchronous slave single deceleration stop time is incorrect.	Each axis	○	

■ Synchronous parameters: Electronic gear-related errors (5100H -)

Code	Name	Description	Object	Recovery	Measures
5100H	Electronic gear - Gear ratio numerator setting error	The setting for the gear ratio numerator of the electronic gear is incorrect.	Each axis	○	Check the set value. If the error occurs repeatedly with the correct set values, consult your Panasonic representative.
5101H	Electronic gear - Gear ratio denominator setting error	The setting for the gear ratio denominator of the electronic gear is incorrect.	Each axis	○	
5102H	Electronic gear - Gear ratio change time setting error	The setting for the gear ratio change time of the electronic gear is incorrect.	Each axis	○	

■ Synchronous parameters: Electronic clutch-related errors (5200H -)

Code	Name	Description	Object	Recovery	Measures
5200H	Clutch - Clutch ON trigger type setting error	The setting for the clutch ON trigger type is incorrect.	Each axis	○	Check the set value. If an error occurs repeatedly with the correct set values, consult your Panasonic representative.
5201H	Clutch - Clutch ON edge selection setting error	The setting for the clutch ON edge selection is incorrect.	Each axis	○	
5203H	Clutch - Clutch OFF trigger type setting error	The setting for the clutch OFF trigger type is incorrect.	Each axis	○	
5204H	Clutch - Clutch OFF edge selection setting error	The setting for the clutch OFF edge selection is incorrect.	Each axis	○	
5207H	Clutch - Clutch ON method setting error	The setting for the clutch ON method is incorrect.	Each axis	○	
5208H	Clutch - Clutch ON slip method setting error	The setting for the clutch ON slip method is incorrect.	Each axis	○	
5209H	Clutch - Clutch ON slip time setting error	The setting for the clutch ON slip time is incorrect.	Each axis	○	
5210H	Clutch - Clutch ON slip curve selection setting error	The setting for the clutch ON slip curve is incorrect.	Each axis	○	
5211H	Clutch - Clutch OFF method setting error	The setting for the clutch ON method is incorrect.	Each axis	○	
5212H	Clutch - Clutch OFF slip method setting error	The setting for the clutch OFF slip method is incorrect.	Each axis	○	
5213H	Clutch - Clutch OFF slip time setting error	The setting for the clutch OFF slip time is incorrect.	Each axis	○	
5214H	Clutch - Clutch OFF slip curve selection setting error	The setting for the clutch OFF slip curve is incorrect.	Each axis	○	

■ Synchronous parameters: Electronic cam-related errors (5300H -)

Code	Name	Description	Object	Recovery	Measures
5300H	Electronic cam - Cam control synchronous master axis cycle setting error	The setting for the cam control synchronous master axis cycle is incorrect.	Each axis	○	Check the set value. If the error occurs repeatedly with the correct set values, consult your Panasonic representative.
5301H	Electronic cam - Used cam pattern no. setting error	The used cam pattern number is out of the range. The used cam pattern number is not registered.	Each axis	○	
5302H	Electronic cam - Cam stroke amount setting error	The setting for the cam stroke amount is incorrect.	Each axis	○	

■ Cam patterns-related errors

Code	Name	Description	Object	Recovery	Measures
5400H	Cam pattern resolution setting error	The setting for the cam pattern resolution is out of the range.	Each axis	○	Check the set value. If the error occurs repeatedly with the correct set values, consult your Panasonic representative.
5401H	Cam pattern set number setting error	The cam pattern set number is out of the range.	Each axis	○	
5402H	Cam pattern section function setting error	The setting for the cam pattern section function is out of the range.	Each axis	○	
5403H	Cam pattern control start position setting error	The setting for the cam pattern control start position is out of the range.	Each axis	○	
5404H	Cam pattern start phase setting error	The start phase setting for each section of cam pattern is out of the range.	Each axis	○	
5405H	Cam pattern displacement setting error	The displacement for each section of cam pattern is out of the range.	Each axis	○	
5406H	Cam pattern cam curve no. setting error	The curve number for each section of cam pattern is out of the range.	Each axis	○	
5410H	Adjustment data total no. setting error	The total number of cam pattern adjustment data is out of the range.	Each axis	○	
5411H	Adjustment data no. setting error	The number of cam pattern adjustment data is out of the range. (cam pattern unit)	Each axis	○	
5413H	Adjustment data control point setting error	The control point of cam pattern adjustment data is out of the range.	Each axis	○	
5414H	Out-of-range adjustment data setting error	The adjustment value of cam pattern adjustment data is out of the range.	Each axis	○	

19.4 Table of Warning Codes

19.4.1 AMP Warnings (A000H -)

- Warnings occurred on the AMP side are output on the FP-XH M8N Control Unit side as warning codes.
- The warning codes output from this unit are written in hexadecimal, however, the warning codes output from the AMP are written in hexadecimal when using A6N/A5N.
- The AMP warnings differ depending on the types of AMP. For details of the processing for AMP warnings, refer to the manual of servo amplifiers.

■ How to read AMP warning codes [For A6N/A5N]

The warning numbers of AMP are obtained by subtracting A000H from the warning codes of this unit.

Example) When an overload protection occurred;

Warning code of this unit: A0A0 H

↓

Subtract A000H from the warning code: 00A0 H

↓

Warning number of AMP: A0 H

19.4.2 Unit Warning (B000H -)

The warning codes upon warnings of the unit are listed below.

Code	Name	Description	Object	Recovery	Measures
B000H	Tool operation	<p>The following request signals were turned ON by the host PLC while the positioning unit is in tool operation.</p> <ul style="list-style-type: none"> • Positioning start request flag (each axis) • Home return request flag (each axis) • JOG forward/reverse rotation request flag (each axis) 	Each axis	○	<p>No requests from the PLC can be executed while the positioning unit is in tool operation.</p> <p>The following requests, however, can be executed from the PLC while the positioning unit is in tool operation.</p> <ul style="list-style-type: none"> • Deceleration stop request flag (each axis) • Emergency stop request flag (each axis) • System stop request flag (all axes) • Pulser operation enabled flag (each axis)
B004H	Realtime torque limit protection	The realtime torque limit was not executed as the AMP parameter operation or AMP monitor operation was being executed.	Each axis	○	Execute the realtime torque limit when the AMP parameter operation and AMP monitor are not used.
B010H	Duplicate start	The same axis was requested to start even though the axis operation has not completed.	Each axis	○	<p>No requests to any axes in operation can be executed.</p> <p>The following requests, however, can be executed while the positioning unit is in operation.</p> <ul style="list-style-type: none"> • Deceleration stop request flag (each axis) • Emergency stop request flag (each axis) • System stop request flag (all axes)
B030H	J-point simultaneous start warning	<p>The J-point speed change contact and J-point positioning start contact turn ON simultaneously during the JOG positioning (J-point) operation.</p> <p>The J-point contact are turned ON while the system is accelerating or decelerating the speed</p>	Each axis	○	<p>When the both contacts turn ON simultaneously, the J-point positioning start contact will have a priority, and the J-point speed change contact will be ignored.</p> <p>Make settings so that the J-point speed change contact will be turned ON while the positioning unit is in operation at constant speed.</p>
B031H	J-point speed change request warning	The J-point speed change contact turned ON when J-point operation is not active.	Each axis	○	Check the timing that the J-point speed change request contact turns ON.
B032H	J-point positioning start request warning	The J-point positioning start contact turned ON when J-point operation is not active.	Each axis	○	Check the timing that the J-point positioning start contact turns ON.
B050H	Torque judgment value warning	<p>The monitored torque value exceeded the specified upper/lower limit value.</p> <p>This warning occurs when setting</p> <ul style="list-style-type: none"> - torque judgment to "Available", - annunciation method to "Warning" 	Each axis	○	Design the system within the range that the torque of the motor does not exceed the judgment value. Check the torque judgment value.

Code	Name	Description	Object	Recovery	Measures
B051H	Actual speed judgment value warning	The monitored actual speed exceeded the specified upper/lower limit value. This warning occurs when setting - actual speed judgment to "Available", - annunciation method to "Warning"	Each axis	○	Design the system within the range that the actual speed of the motor does not exceed the judgment value. Check the actual speed judgment value.
B055H	Pulse input setting warning	The pulse input setting is out of the range.	All axes	○	Check the set value. Check the combination of the input mode, input multiplying, input purpose.
B056H	Pulse count change value setting warning	The specified pulse count changed value is out of the range.	All axes	○	Check the set value.
B060H	Positioning speed change disabled warning (except positioning)	The speed change request contact turns ON before the position control operates	Each axis	○	Please check the time for speed change request ON.
B062H	Positioning speed change disabled warning (during J-point operation)	The speed change request contact turns ON during J-point operation.	Each axis	○	
B063H	Positioning speed change disabled warning (Synchronous slave axis)	The speed change request contact of the slave axis of synchronization turns ON.	Each axis	○	
B064H	Positioning speed change disabled warning (positioning output done)	The speed change request contact turns ON upon completion of position control output.	Each axis	○	
B065H	Positioning speed change disabled warning (during positioning stop operation)	Speed change request contact turns ON during various stops of position control.	Each axis	○	
B066H	Positioning speed change disabled warning (during dwell operation)	Speed change request contact turns ON during dwell time of position control.	Each axis	○	

Error/Warning Annunciation Function

Code	Name	Description	Object	Recovery	Measures
B070H	Positioning movement amount change disabled warning (except positioning)	The speed change request contact turns ON before the position control operates	Each axis	○	Please check the time for movement change request ON.
B071H	Positioning movement amount change disabled warning (during interpolation operation)	Movement change request contact ON during interpolation.	Each axis	○	
B072H	Positioning movement amount change disabled warning (during J-point operation)	Movement change request contact turns ON during J-point operation.	Each axis	○	
B073H	Positioning movement amount change disabled warning (Synchronous slave axis)	The movement change request contact of the slave axis of synchronization turns ON.	Each axis	○	
B074H	Positioning movement amount change disabled warning (positioning output done)	The movement change request contact turns ON upon completion of position control output.	Each axis	○	
B075H	Positioning movement amount change disabled warning (during positioning stop operation)	Movement change request contact turns ON during various stops of position control.	Each axis	○	
B076H	Positioning movement amount change disabled warning (during dwell operation)	Movement change request contact turns ON during dwell time of position control.	Each axis	○	
B100H	Synchronous setting change disabled warning	Request for synchronization settings are made for axis in operation	Each axis	○	Change the synchronous settings when the Busy signal of synchronous target axis is turned OFF.

Code	Name	Description	Object	Recovery	Measures
B110H	Cam pattern table reading error warning	The operation for the cam pattern table reading request ended abnormally as an incorrect value was set or the execution condition was not satisfied.	All axes	○	<ul style="list-style-type: none"> • Confirm the setting values of the parameters required for reading cam patterns. • Confirm if any axes are in synchronous operation. If any, cancel the synchronous operation and read the cam pattern tables. * The details about the cause of the occurrence of this warning are stored in the "cam pattern reading result" area of the positioning memory.
B1111H	Cam pattern table rewriting error warning	The operation for the cam pattern table rewriting request ended abnormally as an incorrect value was set or the execution condition was not satisfied.	All axes	○	<ul style="list-style-type: none"> • Confirm the setting values of the parameters required for rewriting cam patterns. • Confirm if any axes are in synchronous operation. If any, cancel the synchronous operation and rewrite the cam pattern tables. * The details about the cause of the occurrence of this warning are stored in the "cam pattern rewriting result" area of the positioning memory.
B304H	Recalculation exception warning	Error occurs during recalculation	Each axis	○	Please check the parameters of the axes and the settings of the interpolation group.

20

Troubleshooting

20.1 Self-diagnosis Function

20.1.1 Status display LED of the Control Unit

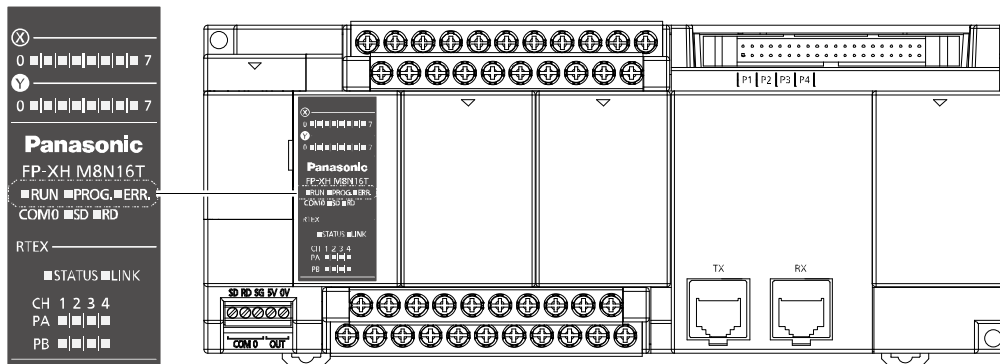

- When an error occurs in the embedded control unit, judge the current situation and stop the running self-diagnosis function as needed.
- When an error occurs, the status display LED of the control unit is as shown in below table.

■ Self-diagnosis related LED display

	LED display			Description	Run
	RUN	PROG.	ERR.		
Normal	○	×	×	In normal operation	Run
	×	○	×	Prog mode In prog mode, even if forcible output is performed, LED does not blink.	Stop
	△	△	×	In RUN mode, during forcible input/output, RUN and PROG. LEDs will blink one by one.	Run
Excepti on	○	×	△	Self-diagnosis error (in operation)	Run
	×	○	△	Self-diagnosis error (being stopped)	Stop
	—	○	○	System monitoring timer stops working	Stop

○: ON, △: Blink, ×: off, —: on or off

20.1.2 Status Display LED of the FP-X Expansion FP0 Adapter

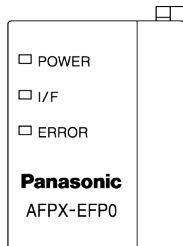

- When an error occurs in the FP0 adapter with embedded FP-X expansion, judge the current situation and stop the running self-diagnosis function as needed.
- When an error occurs, the status display LED of the control unit is as shown in below table.

■ Self-diagnosis related LED display

	LED display			Description
	POWER	I / F	ERR.	
Normal	○	○	×	In normal operation
Abnormal	○	△	×	FP0 / FP0R expansion unit is not connected.
	○	○	△	When the power of the control unit is turned on, the connected FP0 expansion unit detached. The data access between the expansion FP0 adapter and the FP0 / FP0R expansion unit failed due to interference.
	○	×	×	The expansion FP0 adapter power is turned on after the control unit.

○: ON, △: Blink, ×: off, —: on or off

20.1.3 Operation mode in case of exception

- When an error occurs, the system usually stops running. Depending on various type of exception, you can set the system register to choose between keep running or stop.

■ FPWIN GR7 system register setting dialog box

If an error occurs when FPWIN GR7 is used to set PLC, select "Option (O)"→"PLC System Registrar Setting" in the menu bar, and click "Action on Error" tab. The following screen shows.

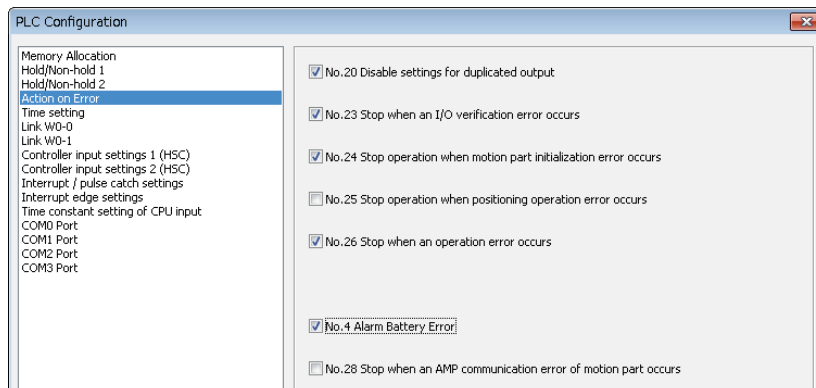

20.2 What to Do If an Error Occurs

20.2.1 ERR LED Blinking

■ **Situation**

A syntax error or self-diagnosis error occurs.

■ **Handling method**



◆ **PROCEDURE**

1. Use the programming tool to confirm the error code.

When a PLC error occurs during programming and commissioning, the Show Status dialog box will be displayed automatically. Please confirm the contents of self-diagnosis errors.

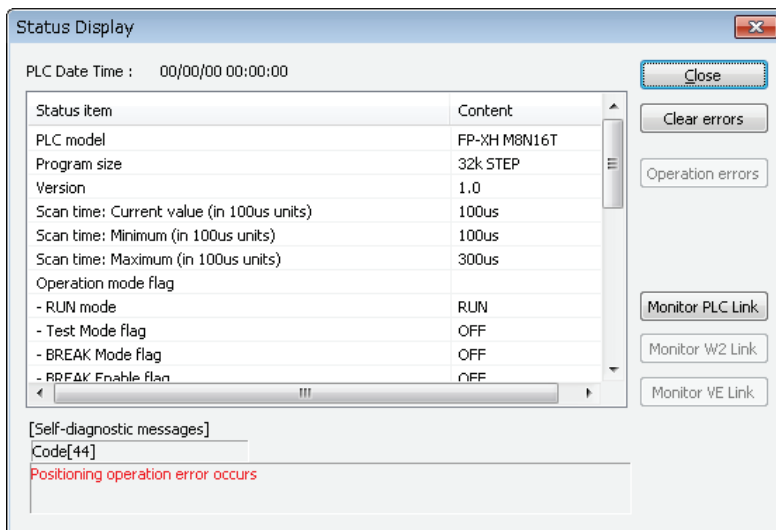

2. Confirm the error code and modify the error reason.

■ Error code and handling method

Error code	Situation	Handling method
1-9	A syntax error occurs.	<ul style="list-style-type: none"> ● Switch PLC to PROG mode and clear error status. ● Use FPWIN GR7 for overall check and identify the address of syntax error and modify the program.
above 20	A self-diagnosis error occurs.	<ul style="list-style-type: none"> ● Adjust settings and programs according to the error code list. ● Use the programming tool in PROG mode and resolve the error status.



◆ KEY POINTS

- When an error with a code above 43 occurs, press the [Clear Error] button in the status display dialog box to clear the error status. In PROG mode, connecting to power supply again also can clear an error. However, contents of the computation memory except data for keeping will be cleared.
- When a computation error (code 45) occurs, the address in which an error occurred is saved to special data register DT90017 and DT90018. Before resolving the error status, click the [Computation Error] button in the dialog box and view the address in which an error occurs.



◆ REFERENCE

- For how to handle the position control error (error code 44), see "Chapter 19 Error/Warning Annunciation Function".

20.2.2 When Not Switched to RUN Mode

■ Situation

When a syntax error occurs or running stops, a self-diagnostic error occurs.

■ Solution

Confirm the situation according to the following steps.



◆ PROCEDURE

1. Confirm whether the ERR LED is lit or not.
2. Use the tool software to perform "Totally Check Project" to confirm the syntax error.

20.2.3 When ERR.LED Lights Up

■ Situation

The system monitoring timer is in operation, the controller stops running.

■ Solution



◆ PROCEDURE

1. **Switch to PROG. mode and turn on the power supply again.**
If the ERR. LED lights again, it may be due to abnormal unit. If off, it may be caused by interference and other temporary reasons.
2. **Switch to RUN mode.**
If the ERR. LED lights up after switching to RUN mode, it means that the program has timed out. Rerun the program.
3. **Check the surrounding environment to confirm if there is interference.**
If the program itself is OK, it may be due to the surrounding environment. Check wirings (includes grounding wire).



◆ KEY POINTS

- **When rechecking the program, confirm the following items.**
Example 1) Confirm whether the program is an infinite loop according to the instructions controlling JP instruction, LOOP instruction and other program processes.
Example 2) The interrupt instruction is continuously executed?

20.2.4 If All LEDs are Not Lit

■ Situation

It may be due to insufficient power supply.

■ Solution

Confirm the situation according to the following steps.



◆ PROCEDURE

1. Recheck the terminal and wiring for looseness after turning off the power.
2. Check that the voltage is applied within the allowable range.
3. Check whether the voltage fluctuation is too large.
4. When sharing power with other devices, disconnect the power from the other devices.

If the unit LED lights up during this operation, it may be due to insufficient power supply capacity. Redesign the power supply.

20.2.5 When Protection Error Message Shows

■ Situation

It may be due to the master memory cassette used or a password is set.

■ Handling method (when using the master memory cassette)

In the case of using the master memory cassette, the program cannot be edited. Turn off the power supply and remove the master memory cassette.

■ Handling method (when using the password function)



◆ PROCEDURE

1. Select "Tools" → "Set PLC Password" in FPWIN GR7.
The "Set PLC Password" dialog box is displayed.
2. Select "Access" and click the [Set] button.

Remove the protection status.



◆ KEY POINTS

- Pressing [Force Cancel] button will delete all programs saved to the PLC.

20.2.6 When the Output is Not Normal

■ Situation

It may be due to the program, I/O assignment and other software problems combined with the wiring, power supply and other hardware problems.

■ Handling method (check of the output side)

Follow the check order of the output and input side to confirm the situation.



◆ PROCEDURE

1. Verify if the output display LEDs of the input and output units are lit.

If lit, perform the next step; if not lit, perform step 4.

2. Recheck the terminal for loose and the wiring status of the load.

If the unit LED lights up during this operation, it may be due to insufficient power supply capacity. Redesign the power supply.

3. Verify if the voltage across the load is normal.

If the voltage is normal, it may be due to an abnormal load. If the voltage is not applied, it may be due to an abnormality in the unit's output.

4. Use the tool software to monitor the output status.

If the monitor state is ON, it may be due to a dual output is used.

5. Use the forcible input / output function of the tool software to force the corresponding outputs turn to ON / OFF.

When the unit output LED is lit, make further checks on the input side. If not lit, it may be due to abnormal unit output part.

■ Handling method (check of the input side)

Confirm the situation according to the following steps.



◆ PROCEDURE

1. Verify if the input display LED of the unit is lit.

If not lit, perform the next step; if lit, perform step 3.

2. Recheck the terminal for loose and the wiring status of the input device.

If the unit LED lights up during this operation, it may be due to insufficient power supply capacity. Redesign the power supply.

3. Verify if the voltage across the input terminal is normal.

If the voltage is normal, it may be due to an abnormal unit input. If the voltage is not applied, it may be due to an abnormal power or input device.

4. Use the tool software to monitor the input status.

If the monitor state is OFF, it may be due to an abnormal unit input.

If the monitor state is ON, recheck the program. When the input device is two-wire sensor, it may be caused by a leakage current.



◆ KEY POINTS

- **When rechecking the program, note the following items.**

1. Check if the output has been rewritten, for example, a dual output is used.
2. Check if the program process has changed via control instructions such as MCR and JMP instruction.
3. Check if the allocation of the I/O mapping is consistent with the installation state.

20.2.7 When Expansion Units are Not Operated

■ Situation

The setting of the expansion unit may be incorrect.



◆ PROCEDURE

1. **Verify if the expansion unit terminal is set correctly.**

Verify if the terminal setting of several units is made.

2. **Verify if the expansion FP0 adapter is attached to the end.**

When the FP-X expansion FP0 adapter is attached to the end, the other expansion unit does not need to be set in the terminal.

3. **Verify if a momentary outage or other short time power on/off are occurred.**

Sometimes, it is unable to identify the expansion unit due to momentary outage and other short time power on/off. Reconnect the power.

20.2.8 In Case of Communication Error (RS-232C)

■ Object

Product no.	Communication Interface	Communication Port No. Assigned				
		Main Unit	Cassette mounting part 1		Cassette mounting part 2	
		COM0	COM1	COM2	COM3	COM4
Control unit standard configuration	RS-232C (3-wire) × 1 channel	•				
AFPX-COM1	RS-232C (5-wire) × 1 channel		•		•	
AFPX-COM2	RS-232C (3-wire) × 2 channel		•	•	•	•
AFPX-COM4	RS-232C (3-wire) × 1 channel			•		•
AFPX-COM5	RS-232C (3-wire) × 1 channel			•		•

■ Situation

Connections and settings may be incorrect.



◆ PROCEDURE

1. Confirm the setting of the system register.

Verify if the setting corresponding to the communication port number assigned is correct. When selecting the inter-PLC link, verify if the connection area is repeated.

2. Verify if the CS signal is ON.

When using 3-wire type, set the connection RS signal and CS signal to ON. When using 5-wire type, verify the RS signals of the communication cassette LED and the matched devices.

3. Verify the connection with the matched devices.

Confirm that the SD terminal of the matched device is connected to the RD terminal at the PLC side, and the RD terminal of the matched device is connected to the SD terminal at the PLC side. Also, make sure the SG terminals from both devices are connected.

20.2.9 In Case of Communication Error (RS-422)

■ Object

Product no.	Communication Interface	Communication Port No. Assigned				
		Main Unit	Cassette mounting part 1		Cassette mounting part 2	
		COM0	COM1	COM2	COM3	COM4
AFPX-COM3	RS-485 / RS-422 × 1 channel		•		•	

■ Situation

Connections and settings may be incorrect.



◆ PROCEDURE

1. **Confirm the setting of the system register.**
Verify if the setting corresponding to the communication port number assigned is correct. When selecting the inter-PLC link, verify if the connection area is repeated.
2. **Verify if the terminal station is connected properly.**
3. **Verify if the transmission cable is securely connected to the data send terminal and data receive terminal.**
4. **Verify if the transmission cable is within the specifications.**

20.2.10 In Case of Communication Error (RS-484)

■ Object

Product no.	Communication Interface	Communication Port No. Assigned				
		Main Unit	Cassette mounting part 1		Cassette mounting part 2	
		COM0	COM1	COM2	COM3	COM4
AFPX-COM3	RS-485 / RS-422 × 1 channel		•		•	
AFPX-COM4	RS-485 × 1 channel		•		•	
AFPX-COM6	RS-485 × 2 channel		•	•	•	•

■ Situation

Connections and settings may be incorrect.



◆ PROCEDURE

1. Confirm the setting of the system register.

Verify if the setting corresponding to the communication port number assigned is correct. When selecting the inter-PLC link, verify if the connection area is repeated.

2. Verify if the terminal station is connected properly.

Do not set the unit outside both sides of the network as the terminal exchange.

3. Verify if the transmission cable is securely connected to the transmission terminals of the devices by (+) and (+), (-) and (-).

4. Verify if the transmission cable is within the specifications.

Do not use more than one type of cable.

20.2.11 In Case of Communication Error (Ethernet)

■ Object

Product no.	Communication Interface	Communication Port No. Assigned				
		Main Unit	Cassette mounting part 1		Cassette mounting part 2	
		COM0	COM1	COM2	COM3	COM4
AFPX-COM5	Ethernet × 1 channel		•		•	

■ Situation

Connections and settings may be incorrect.

■ Verification steps (when the ERR.LED is not lit)

Connections and settings may be incorrect.



◆ PROCEDURE

1. **Confirm the setting of the system register.**
Verify if the setting corresponding to the communication port number assigned is correct.
2. **Verify if the LAN cable is securely connected to the cassette or computer.**
3. **When using the HUB during connection, verify if the power of the HUB has been connected.**
4. **Verify if the LINK / ACT LED is lit.**
If not lit, it indicates that the LAN cable is not connected properly.
5. **Verify the IP address and the IP address of the other end of the connection.**
6. **Verify if the transmission mode and speed of the COM1 port of the control unit are consistent with the communication environment setting of the FP-X communication cassette (AFPX-COM5).**

■ Verification steps (when the ERR.LED is lit)

Connections and settings may be incorrect.



◆ PROCEDURE

1. **Verify the status via the Configurator WD.**
There is an IP address conflict on the network if the status is displayed "IP Conflict Error". Do not set conflicted IP address.
It is unable to get IP from the DHCP server if the status is displayed "DHCP Error". Verify if there is an exception in the network system.

20.3 What to Do If an Error Occurs

20.3.1 Cannot Communicate with AMP

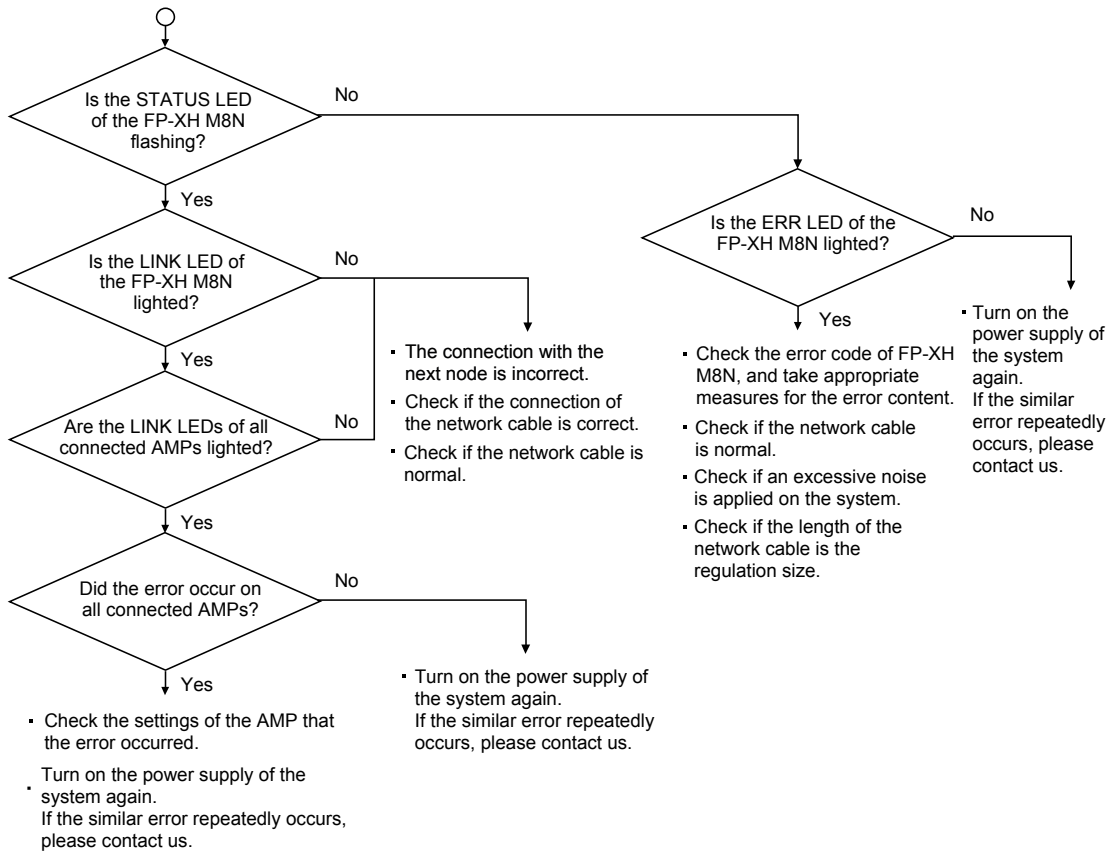

20.3.2 Motor does Not Rotate and Operate

■ Solution 1:

Please confirm if the servo ON request is ON and the servo for AMP is locked. When attempting to activate an axis that is not in the servo-locked state, the not servo ready error (3000H) occurs.

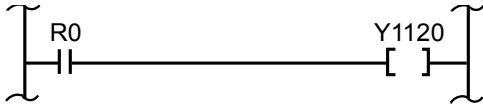
**■ Solution 2:**

Review the program.

Point to check

Check to make sure the I/O numbers are appropriate.

Check non-rewriting of the start flag in the program.

Check the input valid logic of the over limit switch. In this case, the ERR.LED is on.)

21

**Memory /Master Memory
Cassette**

21.1 Memory Backup

21.1.1 Program Memory Backup

The contents downloaded to the control unit can be saved even in case of power outage.

■ Program Memory Backup

Type	Remarks
Program	
Comments	Maximum 200KB I/O comments, description, comments between the lines
System register	
Positioning data	Contains positioning parameters and positioning table data set by the Configurator PM7.

21.1.2 Operation Memory Backup

- The operation memory includes outage hold and non-hold area.
- In the FP-XH M8N Control unit, backup fixed area in case of a power outage or mode switching (RUN → PROG.).

■ Non-hold and hold area

Type	Description
Non-hold area	In case of a power outage or mode switching (RUN → PROG.), the data content is reset to 0.
Hold area	In case of a power outage or mode switching (RUN → PROG.), maintain the previous operational data.

■ Automatic backup in case of an outage

Type	Hold Area	
Counter	16 points	C1008 - C1023
Counter elapsed value area	16 words	EV1008 - EV1023 (note 1)
Internal relay	128 points	R5040-R511F
Data register	315 words	(Note 2) DT11970 - DT12284 (When 40k step program capacity is selected) DT32450 - DT32764 (When 32k step program capacity is selected) DT65218 - DT65532 (When 12k step program capacity is selected)

(Note 1): You can not hold counter target value area SV.

(Note 2): The data register range varies from the system register No.0 internal relay capacity setting.

■ Backup based on user program P13 (ICWT) instruction

Type	Description
How to use	The user program allows you to write P13 (ICWT) instruction and transfer the data register to the F-ROM area. Specifies the continuous range for using the 2K words as 1 memory block. Read from the F-ROM area to the data register by F12 (ICRD) instruction.
No. of times of writing	Less than 10 thousand times

21.1.3 Operation Memory Backup (When Battery Installed)

- Initially, install the backup battery sold separately when the hold area is insufficient or using the clock/calendar function.
- After installing the battery, all the following areas also can be backed up in case of a power outage or mode switching (RUN→PROG.).

■ Backup using a backup battery

Type		Hold area	
Operation memory	Timer		The tool software allows you to set the system register no. 6 - no.13 and specify any hold / non-hold area. (You can also keep the whole point)
	Timer elapsed value area		
	Internal relay		
	Data register		
	Step ladder diagram		
	Link relay		
	Link register		
Special data register	Clock/calendar	Monitoring area	DT90053: hour/min (read only)
		Setting/motoring area	DT90054: min/sec, DT90055: day/hour, DT90056: year/month, DT90057: week

(Note 1): If detects that the battery is running out when the power is on, the operation memory of the hold area will be cleared to 0.

■ Backup battery type (sold separately)

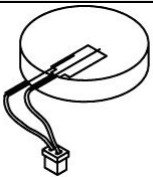
Appearance	Product Name	Specification	Product no.
	Backup battery for FP-XH	With connector	AFPXHBATT

(Note): You can not use the old model FP-X series battery.

■ Number of installed batteries

For FP-XH M8N only one battery can be installed.



◆ REFERENCE

- For battery installation methods, refer to "4.2 Backup Battery Installation".

21.1.4 Alarm Battery Error / Setting of the Hold area

■ Setting of alarm battery error

- If a backup battery installed, select the "System Register No. 4 Alarm Battery Error" check box.
- When the battery capacity is low, the ERR.LED of the control unit flashes and an error alarm occurs.

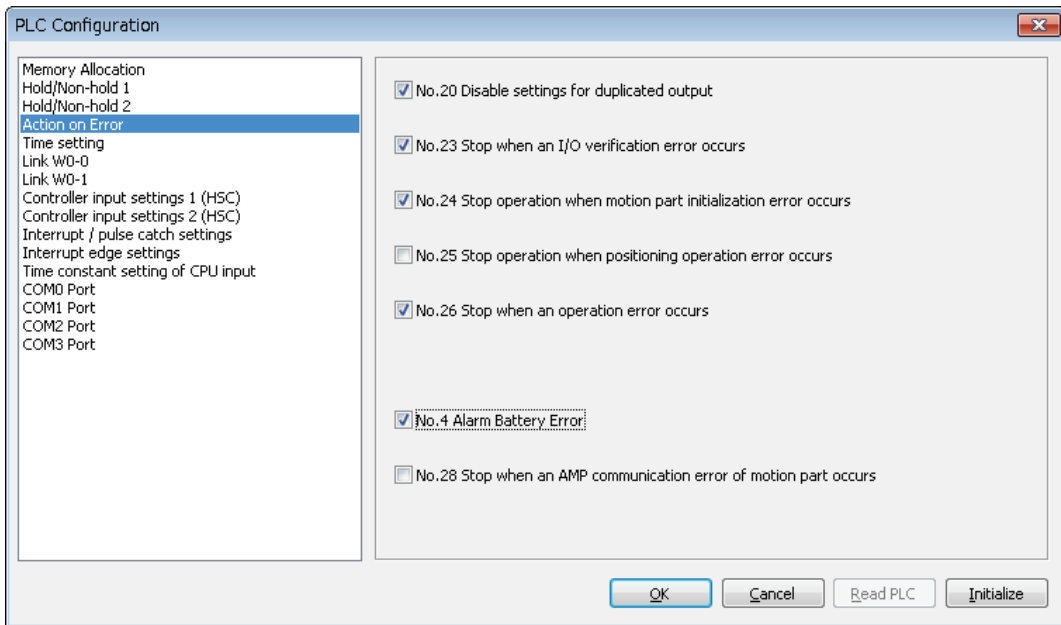

■ Setting of the hold / non-hold area

When changing the range of the hold area of data registers and other operation memory areas, set the system register no. 6 - no. 14.

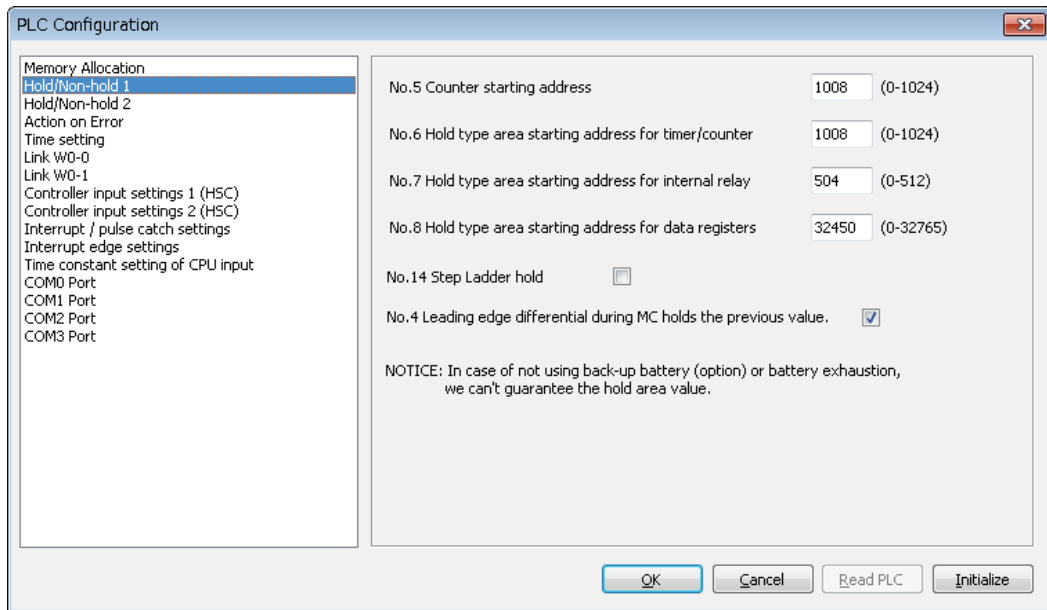

◆ KEY POINTS

- If the "Alarm Battery Error" is not set, the ERR.LED will not blink even if a battery error is detected.
- The setting of the system register no. 6 - no. 14 are only effective when the backup battery is installed. Use the initial values directly when the battery is not installed.

21.2 RAM / ROM Transfer Function

21.2.1 Outline of function

Through an operation based on the tool software, all contents of the hold area of the data register DT can be backed up to the F-ROM area of the control unit built-in memory.

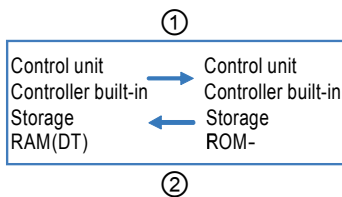

21.2.2 Operations Using Tool Software

Explain it as below assuming that the FPWIN GR7 has been started.



◆ PROCEDURE

1. Select "Online" → "Switch to Online Mode" from the menu bar.
2. Select "Tools" → "ROM<=>RAM Transfer" from the menu bar.

The "ROM <=> RAM Transfer" dialog box is displayed.

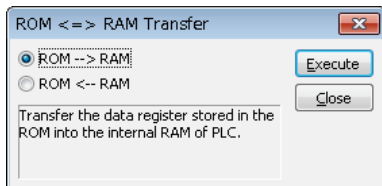

3. Select the transfer direction and click the [Execute] Button.

For ROM-> RAM transfer, transfer from the F-ROM area to the data register area.

For RAM-> ROM transfer, transfer from the data register area to the F-ROM area.



◆ KEY POINTS

- Only PROG. mode can be performed.
- Transfer data in all areas of the data register.

21.3 Functions of Master Memory Cassette

21.3.1 Outline of Functions

The master memory cassette includes functions such as memory backup, replication and real-time clock. Only one of the functions can be installed to the FP-XH M8N Control unit.

■ Master memory function

Item	Specification	
Clock/calendar (real-time clock)	Setting items	Year (last 2 numbers in the Gregorian calendar), month, day, hour (24-hour) minute, second, week
	Accuracy	0 °C: Month error in 104 seconds or less, 25 °C: Month error in 51 seconds or less, 55 °C: Month error in 155 seconds or less
Master memory function	Memory capacity	Flash-ROM (512kB)
	Storable data	System register, ladder diagram program, position control data and comment data (200kB) F-ROM data area, security function (password, upload prohibited)

21.3.2 Setting of Master Memory Unit

■ Setting of the Function Toggle Switch

Confirm the switch position before installation.

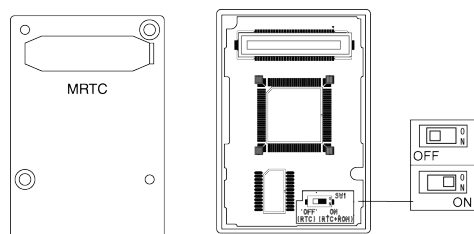

Switch position	Specifications
OFF (RTC)	Position of factory setting. Only runs the real-time clock function.
ON (RTC + ROM)	The real-time clock function and master memory function are activated.

21.4 Master Memory Function

21.4.1 Outline of Function

Use the master memory function when backing up and duplicating the program and data saved in the control unit.

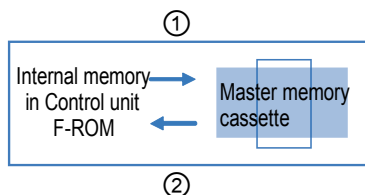

■ Control unit ← → master memory transfer

Transfer direction	Transfer method	Transferred content
①	Operations Using the Tool Software	(Data must be transmitted) Ladder diagram program, system register, position control data, safety information (password)
		(Data selected via dialog boxes) Safety information (upload prohibited), comment data, F-ROM data area (note 1) (note 2)
②	Operations Using the Tool Software	(Data must be transmitted) Ladder diagram program, system register, position control data, safety information (password)
		(Data selected via dialog boxes) (note 3) comment data, F-ROM data area
	Switch to RUN mode Power ON in RUN mode	All contents written into the master memory unit are transferred to the internal memory of the control unit (F-ROM).

(Note 1): According to memory block no., specify the F-ROM data area in 2K words unit.

(Note 2): Delete the items unselected during built-in memory → master memory transferring from the master memory.

(Note 3): There is no comment data on the master memory. For the F-ROM data area, select via the menu is not available.

21.4.2 Before Turning on the Power

When the master memory cassette function toggle switch is ON (RTC + ROM) and the master memory function is active, depending on the different modes when the power is ON, the operation changes as follows.

■ When the power is turned on in PROG. mode

- When the power is turned on, change to the state indicating that data exists in all control units and master memory units (program, comments, system register data, data register and position register).
- Through the operation of the tool software, built-in memory → master memory transfer or master memory → built-in memory transfer can be performed.
- When you copy the data saved in the control unit to the master memory cassette, turn on the power in PROG. mode. When you switch to RUN mode, transfer the contents of the master memory cassette to the built-in memory.

■ When the power is turned on in the RUN mode

- When the power is turned on, transfer the data saved in the master memory unit (program, comments, system register data, data register) to the memory of the control unit.
- Data saved in the control unit before powering on will be overwritten.
- When the required data (program, comments, system register data, data register) has already saved to the master memory, turn on the power in RUN mode.



◆ KEY POINTS

- **Perform the installation of the master memory cassette and the data transmission from the control unit to the master memory cassette after the setting and program editing are completed. Depending on the different operating conditions, the following errors will occur.**

Error message	Operating conditions
42FromPLC: Basic step error NOT support error	Upload prohibited status
63FromPLC: Application error mode error	When you want to perform the transfer operation of the master memory cassette in RUN mode.
65FromPLC: Application error protection error	When you want to edit the program with the master memory cassette installed.
The master memory is not installed in the PLC connected.	The function toggle switch in the master memory cassette can not switch to ON (RTC + ROM side). Or the master memory cassette is not installed.

- **When installing or removing the cassette with the power turned on, an I/O verification error will occur.**

21.4.3 Transferring Data to Master Memory Cassette

Comments and data register set through the program, system register, position register and options can be transferred to the master memory cassette.

■ Operating steps

Please follow these steps to transfer data to the master memory cassette from the control unit. Operate via FPWIN GR7. Explain it as below assuming that the FPWIN GR7 has been started.



◆ PROCEDURE

1. Select "Online" → "Switch to Online Mode" from the menu bar.
2. Select "Tools" → "Internal Memory<=>Master Memory" from the menu bar.

The "Internal Memory <=> Master Memory" dialog box is displayed.

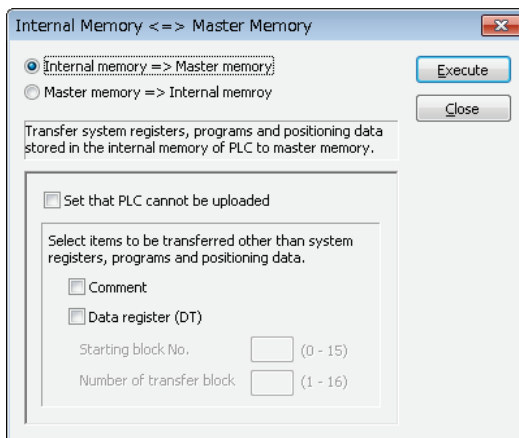

3. Select the transfer direction and click the [Execute] Button.

The message is displayed at the end of the transmission.

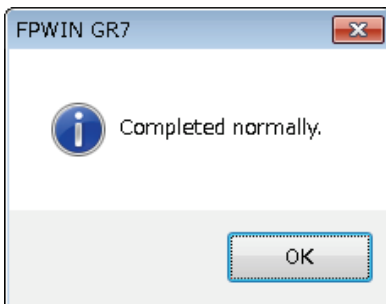

■ Option setting

Type	Description
Upload protection	Create the master memory cassette set in the upload prohibited status when the check box is selected. The control unit in which installed the master memory cassette and perform transferring changes to upload prohibited status.
Comments	Transfer the comments saved in the control unit built-in memory (F-ROM) (I/O comments, descriptions, comments between the lines) when the check box is selected.
F-ROM data area (for data register transfer)	Transfer the data for data register saved in the F-ROM data area of the control unit to the master memory cassette when the check box is selected. Specify the starting block No. and the number of the transfer blocks. The unit of the memory block is 2 words. The maximum number of the memory blocks can be transferred to the master memory is 20 (40,960 words).

■ Assigning of the F-ROM data area

Block no.	DT number conversion range		Block No.	DT number conversion range	
0	DT0	DT2047	16	DT30768	DT32815
1	DT2048	DT4095	17	DT32816	DT34863
2	DT4096	DT6143	18	DT34864	DT36911
3	DT6144	DT8191	19	DT36912	DT38959
4	DT8192	DT10239	20	DT38960	DT41007
5	DT10240	DT12287	21	DT41008	DT43055
6	DT12288	DT14335	22	DT43056	DT45103
7	DT14336	DT16383	23	DT45104	DT47151
8	DT16384	DT18431	24	DT47152	DT49199
9	DT18432	DT20479	25	DT49200	DT51247
10	DT20480	DT22527	26	DT51248	DT53295
11	DT22528	DT24575	27	DT53296	DT55343
12	DT24576	DT26623	28	DT55344	DT57391
13	DT26624	DT28671	29	DT57392	DT59439
14	DT28672	DT30719	30	DT59440	DT61487
15	DT30720	DT30767	31	DT61488	DT65535



◆ KEY POINTS

- Temporarily delete all data in the master memory cassette when the transmission begins. Comments and F-ROM data values that are not selected as the transmission range will not be saved in the master memory cassette.
- Transfer data from the control unit built-in RAM to the F-ROM area through the "RAM → Transfer Function" of the tool software or P13 (ICWT) instruction.
- Writing by P13 (ICWT) instruction and reading by F12 (ICRD) instruction can perform up to 32 blocks (up to 65536 words).

21.4.4 Transferring Data from Master Memory Cassette to Control Unit

The data saved in the master memory cassette can be transferred to the control unit by the following methods.

■ Operating steps

Use FPWIN GR7 and follow these steps to transfer data to the master memory cassette from the control unit. Explain it as below assuming that the FPWIN GR7 has been started.



◆ PROCEDURE

1. Select "Online" → "Switch to Online Mode" from the menu bar.
2. Select "Tools" → "Internal Memory<=>Master Memory" from the menu bar.

The "Internal Memory <=> Master Memory" dialog box is displayed.

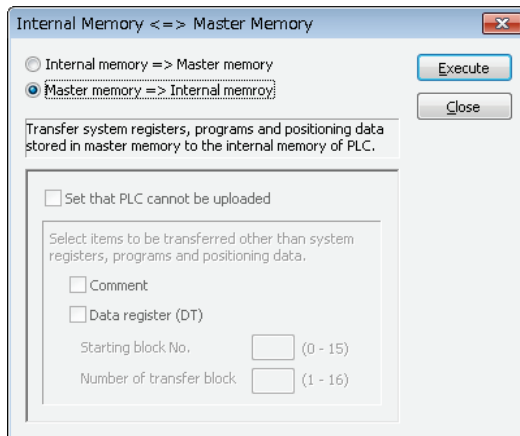

3. Change the transfer direction to "Master memory => Internal Memory", click the "Execute" button.

The message is displayed at the end of the transmission.

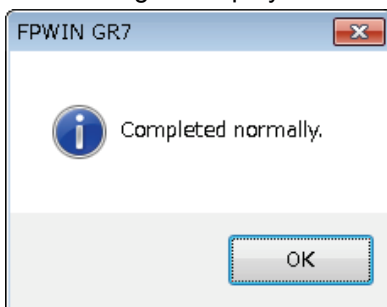

◆ KEY POINTS

- After the transfer, and PROG is switched to RUN, the contents in the master memory cassette and the internal memory are checked. The transfer process is not performed if consistent.

■ Option setting

Type	Description
Comments	Comments saved in the master memory cassette (I/O comments, descriptions, comments between the lines) are transferred to the control unit built-in memory (F-ROM) when the check box is selected. The check box is not displayed when there is no comment data saved in the master memory unit.
F-ROM data area data register	The data saved in the master memory cassette is transferred to the F-ROM data area of the control unit when the check box is selected. The check box is not displayed when there is no data saved in the master memory unit.

21.4.5 Using Master Memory Cassette with Other Models

The master memory unit created for the FP-XH M8N control Unit cannot be used for other models (such as FP-X and FP-XH).

21.5 Clock/Calendar

21.5.1 Outline of Function

- The master memory cassette has clock/calendar function.
- The time data is stored in the special data register for reading and using the user program.

■ Functions of the master memory unit

Item	Specification	
Clock/calendar (real-time clock)	Function	Year (last 2 numbers in the Gregorian calendar), month, day, hour (24-hour) minute, second, week Applicable until 2099. Applicable during leap years.
	Accuracy	0 °C: Month error in 104 seconds or less, 25 °C: Month error in 51 seconds or less, 55 °C: Month error in 155 seconds or less

■ Areas used via the clock/calendar

Special DT number	Data content				R	W
	High byte		Low byte			
DT90053	Time data	H00 - H23	Minute data	H00 - H59	○	×
DT90054	Minute data	H00 - H59	Second data	H00 - H59	○	○
DT90055	Day data	H00 - H31	Time data	H00 - H23	○	○
DT90056	Year data	H00 - H99	Month data	H00 - H12	○	○
DT90057	—		Week data	H00 - H06	○	○

(Note 1): Specifies any week data within the range of H00 - H06.

21.5.2 Clock/calendar Setting

You can set the clock/calendar through the tool software or the user program.

■ Tool software setting

Select the "PLC Date / Time Settings" menu. If the week data is required to set, please set through the user program.

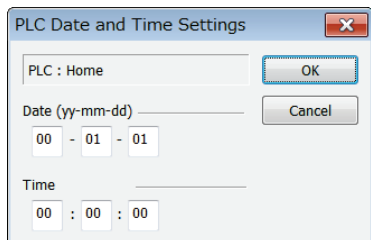

◆ KEY POINTS

- Backup the clock/calendar data through a battery. Install the battery before setting.

■ Setting based on the user program

After the time data is written in the special data register DT90054 - DT90057, write H8000 in DT90058. Perform the transmission by following the order of H8000→H0000 or using the differential instruction. Always remember not to input H8000.

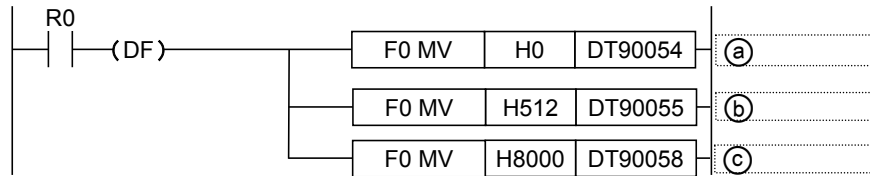

(a)	Set 0 minutes 0 seconds	(b)	Set 5 days 12 hours	(c)	Time alignment
-----	-------------------------	-----	---------------------	-----	----------------

21.5.3 Clock/calendar Application Examples

■ Application example (regular automatic start)

- Use the clock/calendar (real-time clock) function to output 1 second (Y0) signal at 8:30 am every day. In this example, the "hour, minute data" stored in the special data register DT90053 are used to output signal regularly.
- In DT90053, the "hour data" and "minute data" are respectively stored in the high 8 bytes and low 8 bytes in the form of BCD. When compare this "hour, minute data" and the value of any time (BCD), use the special internal relay R900B (= flag) to check if the time is consistent.

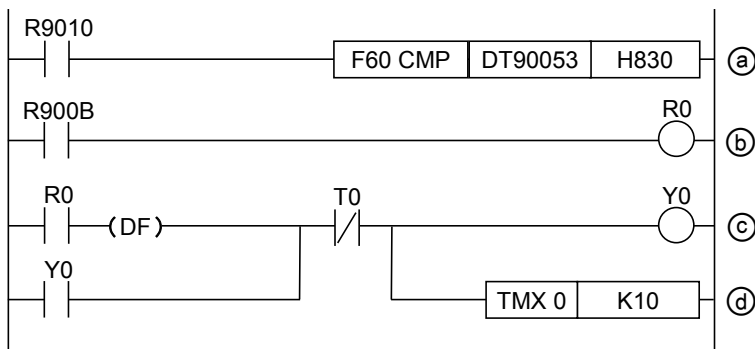

(a)	Compare the value of special data register DT90053 (hour, minute data) and H830 (8:30).				
(b)	Output if consistent	(c)	Output pulse at a fixed time (1 second)	(d)	0.1 s timer setting K10, used as 1 s timer

22

Security Functions

22.1 Password Protection Function

22.1.1 Outline of Function

■ Outline of password protection function

This function is used to prohibit reading and writing programs and system registers by setting a password. There are two ways to set a password as below.

1. Set by using the programming tool
2. Set by instructions (SYS1 instructions), but 32-digit password cannot be set in this case.

■ Characters can be used by the password

Password digits	Characters can be used
4-digit password	4 characters of the "0" to "9" and "A" to "F" (16 characters) can be used.
8-digit password	You can use 8 or less half-width alphanumeric characters (case sensitive) and symbols.
32-digit password	You can use 32 or less half-width alphanumeric characters (case sensitive) and symbols.



◆ NOTE

- **Never forget your password. You can not read the program if you forget your password. This is not possible even you ask for help from our company.**

22.1.2 Tool software setting

■ Setting based on FPWIN GR7

1. Select [Online] → [Switch to Online Mode] from the menu bar, or press <CTRL> + <F2> keys simultaneously.

The screen switches to [Online Monitor].

2. Select [Tools] → [PLC Security Settings] → [Set PLC Password] from the menu bar.

The "Set PLC Password" dialog box is displayed.

■ PLC password setting dialog box



①	Display the current status of the password setting.
②	Specify the type of passwords used.
③	Specify password behavior. Access: enter the password for program access operation. Protect: a password is set. Unprotect: remove the password setting.
④	Enter the password.

■ Confirmation of password Settings

Item		Settings
Current state	Password is not set	No password is set.
	xx digits Protect (note)	A password is set, no access.
	xx digits Available to access (note)	A password is set, allow access. (Password input is completed, the program can be accessed.)
Retry number		Namely the maximum number for consecutive password input. Each time the password is entered incorrectly, the retry number decreased (up to 3 times). If there has been three consecutive failed password attempts, you can not access the program. To reenter the password, set the PLC's power to OFF / ON and reboot.

(Note): XX is one of 4, 8, 32 depending on the digits of the password set.



◆ NOTE

- When the access is allowed, if the PLC power supply is set to OFF / ON, it will return to the password protection status again.

■ **Setting to prohibit access with a password**

1. Select [Tools] → [PLC Security Settings] → [Set PLC Password] from the menu bar. The "Set PLC Password" dialog box is displayed.

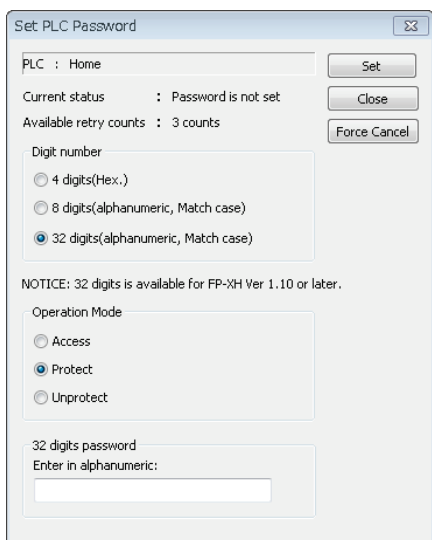

2. Set the items in the table below, click [Set] button.

Item	Settings
Digits	Please set the digits.
Operation mode	Select "Protect".
4, 8, 32-digit password	Enter any password to be set.

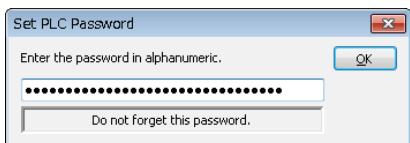

3. In order to confirm, enter the password again, click the [OK] button. The following information is displayed when entering a state (protected state) that is forbidden to write / read.

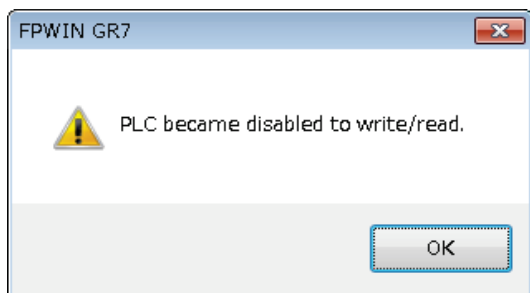

4. Click the [OK] button.

■ **Setting to allow access with a password**

1. Select [Tools] → [PLC Security Settings] → [Set PLC Password] from the menu bar. The "Set PLC Password" dialog box is displayed.

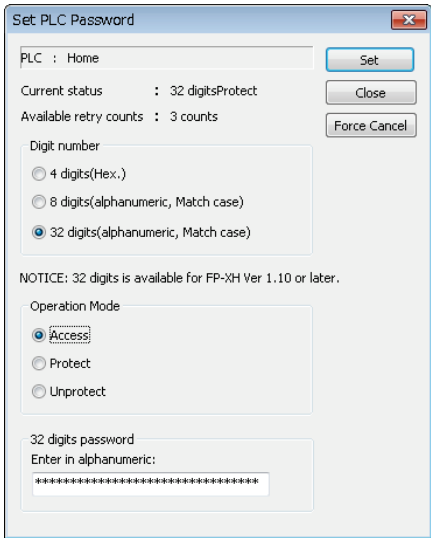

2. Set the items in the table below, click [Set] button.

Item	Settings
Digits	Please set the digits.
Operation mode	Select "Access".
4, 8, 32-digit password	Enter a set password.

When allowing access, the following information is displayed.

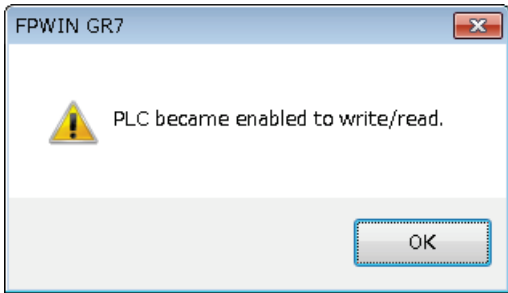

3. Click the [OK] button.



◆ **NOTE**

- **When the " Access" status stays unchanged, if the PLC power supply is set to OFF / ON, it will become password protection status again.**

■ Password protection removal

The following 2 methods can be used to remove password setting.

	Description	Program
Password removal	Specify and remove the logged password.	Hold all
Compulsory removal	Remove the password by deleting all programs and security information.	Delete all (also delete upload prohibited setting)

1. Select [Tools] → [PLC Security Settings] → [Set PLC Password] from the menu bar. The "Set PLC Password" dialog box is displayed.

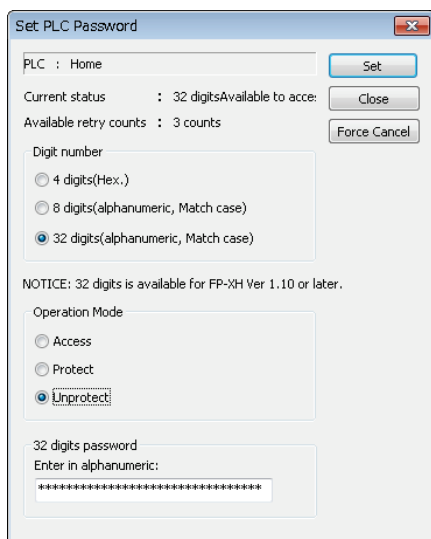

2. Set the items in the table below, click [Set] button.

Item	Settings
Digits	Please set the digits.
Operation mode	Select "Unprotect".
4, 8, 32-digit password	Enter a set password.

After the password removal is completed, the following message is displayed.

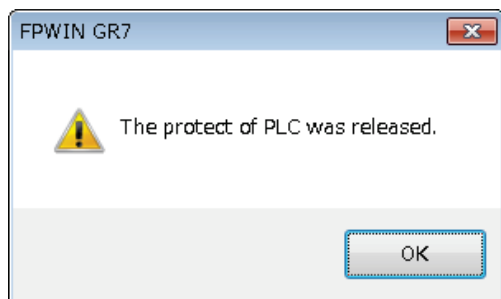

3. Click the [OK] button.

**NOTE**

- The password removal operation can only be performed in the "Allow Access" status.

■ Compulsory removal method (programs and security information all deleted)

1. Select [Tools] → [PLC Security Settings] → [Set PLC Password] from the menu bar. The "Set PLC Password" dialog box is displayed.

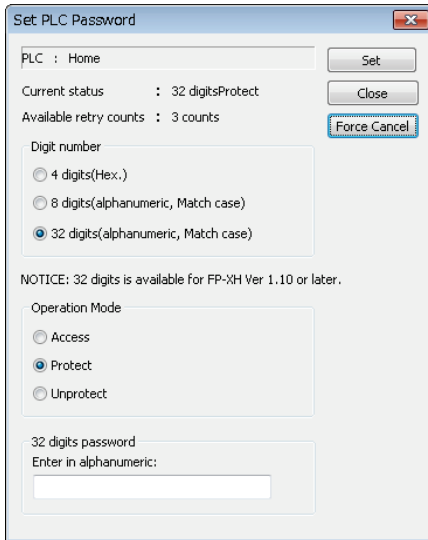

2. Click the [Force Cancel] button. The confirmation message is displayed.

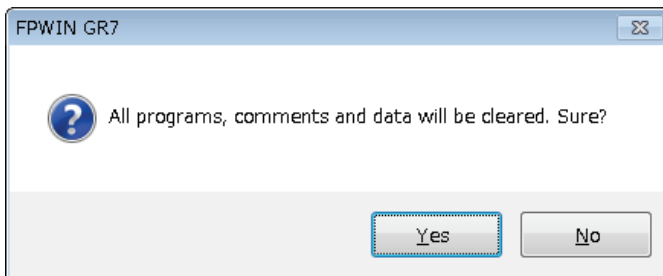

3. Confirm the message and click the [Yes] button.

The current status is displayed as "Password is not set". All programs and security information have been deleted.

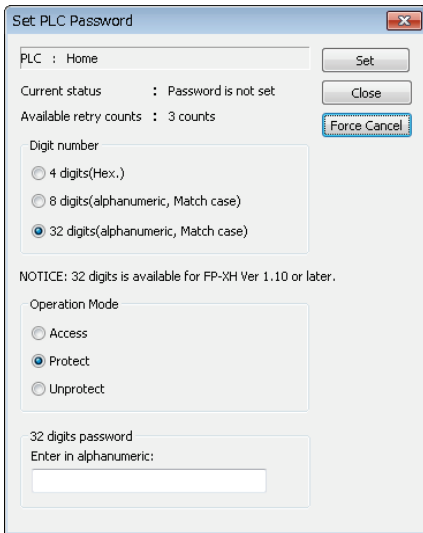

The screenshot shows a dialog box titled "Set PLC Password" with a standard Windows window control bar (minimize, maximize, close). The dialog contains the following elements:

- A text field labeled "PLC : Home" with a "Set" button to its right.
- A status line: "Current status : Password is not set" with "Close" and "Force Cancel" buttons to its right.
- A label "Available retry counts : 3 counts" with a "Force Cancel" button below it.
- A section titled "Digit number" with three radio button options:
 - 4 digits(Hex.)
 - 8 digits(alphanumeric, Match case)
 - 32 digits(alphanumeric, Match case)
- A "NOTICE" text: "NOTICE: 32 digits is available for FP-XH Ver 1.10 or later."
- A section titled "Operation Mode" with three radio button options:
 - Access
 - Protect
 - Unprotect
- A section titled "32 digits password" with a label "Enter in alphanumeric:" and an empty text input field below it.

22.2 Program Upload Protection Function

22.2.1 Outline of Function

■ Outline of the program upload protection function

- This function is to prohibit reading programs and system registers by setting to disable program uploading.
- If the upload protection is set, note that the ladder programs and system registers will be disabled to be uploaded after that.
- The setting can be cancelled using the programming tool, however, all ladder programs, system registers and password information will be deleted when the setting is cancelled.
- Editing the files that are controlled with a PC can be carried out online using the programming tool. However, the programs will be broken if the programs are not absolutely matched. When using this function, store ladder programs as files without fail.

■ Interaction with the password protect function

- The password setting can be specified simultaneously for the PLC in which this function is set.
- This function can be also set in a password-protected PLC.



◆ NOTE

- **All programs and security information will be deleted when the upload protection setting is cancelled. We cannot restore the deleted programs even if you ask us.**

22.2.2 Tool Software Setting

■ Setting based on FPWIN GR7

1. Select [Online] → [Switch to Online Mode] from the menu bar, or press <CTRL> + <F2> keys simultaneously.

The screen switches to [Online Monitor].

2. Select [Tools] → [PLC Security Settings] → [Upload Protection] from the menu bar.

The dialog box of "Disable Uploading" appears.

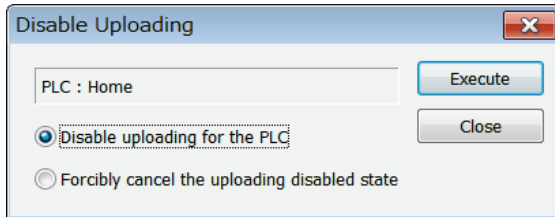

3. Select "Disable uploading for the PLC" and click the "Execute" button.

■ Compulsory removal based on FPWIN GR7

In the "Disable Uploading" dialog box, select "Forcibly cancel the uploading disabled state", and then press the [Execute] key.

22.3 Security Function Applicability List

22.3.1 Control Unit

The safe operating conditions of the control unit vary according to the presence or absence of the master memory cassette.

■ No master memory cassette

		Security status				
		Security function is not set	Upload prohibited	4-digit password	8-digit password	32-digit password
Sets/ cancels	Upload protection	A		A	A	A
	4-digit password	A	A		N/A	N/A
	8-digit password	A	A	N/A		N/A
	32-digit password	A	A	N/A	N/A	

A: Available, N/A: Not available

■ When a master memory cassette is installed

		Security status				
		Security function is not set	Upload prohibited	4-digit password	8-digit password	32-digit password
Sets/ cancels	Upload protection	N/A		N/A	N/A	N/A
	4-digit password	N/A	N/A		N/A	N/A
	8-digit password	N/A	N/A	N/A		N/A
	32-digit password	N/A	N/A	N/A	N/A	

A: Available, N/A: Not available

23

General-purpose Input / High-speed counter Function

23.1 General-purpose Input / High-speed counter Function Summary

23.1.1 High-speed counter Function Summary

- It is the function which can perform high-speed count for input signal from sensor and encoder.
- When the counted value is consistent with a target value, the special instruction (F166/F167) which can change any output (Y0 - Y29F) to ON or OFF by interrupt processing are provided. When the output changes to ON/OFF, you can use presets such as SET/RET instruction.
- Designate used channel and input with system registers. Designate output in case of consistency with the operand of instruction.

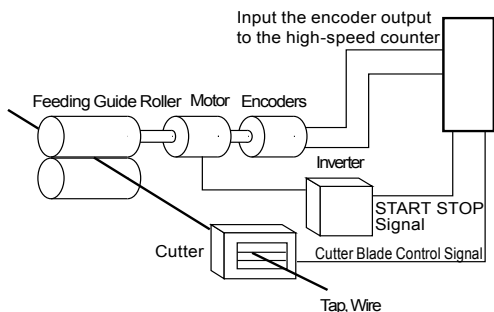

23.1.2 Counting Range and Elapsed Value (Current Value) Area

- The high-speed counter's elapsed value is stored in the special data register as 2-word 32-bit data.
- When the power turns to OFF, the elapsed value area is reset. It is held when the RUN mode is switched to the PROG. mode.
- The high-speed counter is a ring type counter. When the counted value exceeds the maximum value, it is restored to the minimum value. When the counted value is lower than the minimum value, it is restored to the maximum value.

■ Counting range of the elapsed value (current value) area

Division	Range
For high-speed counter control	K-2,147,483,648-K2,147,483,647

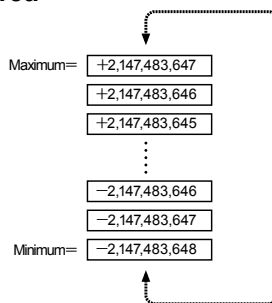

23.1.3 When using the high-speed counter function

■ Control unit

Channel number	Count input	Hardware reset input	Used memory area			Performance specification		
			Control flag	Elapsed value area	Target value area	Min. input pulse width	Max. count speed	
[Single Phase] addition input subtraction input	CH0	X0	X6	R9110	DT90300 DT90301	DT90302 DT90303	Mid-speed input 50 μs	10kHz
	CH1	X1	No	R9111	DT90304 DT90305	DT90306 DT90307		
	CH2	X2	X7	R9112	DT90308 DT90309	DT90310 DT90311		
	CH3	X3	No	R9113	DT90312 DT90313	DT90314 DT90315		
	CH4	X4	No	R9114	DT90316 DT90317	DT90318 DT90319		
	CH5	X5	No	R9115	DT90320 DT90321	DT90322 DT90323		
	CH6	X6	No	R9116	DT90324 DT90325	DT90326 DT90327		
[2-phase] Phase difference input Individual input Direction detection	CH0	X0 X1	X6	R9110	DT90300 DT90301	DT90302 DT90303	Mid-speed input 100 μs	10kHz
	CH2	X2 X3	X7	R9112	DT90308 DT90309	DT90310 DT90311		
	CH4	X4 X5	No	R9114	DT90316 DT90317	DT90318 DT90319		
	CH6	X6 X7	No	R9116	DT90324 DT90325	DT90326 DT90327		

(Note 1): X6 can be used for either CH6 count input or CH0 reset input. X7 can be used for CH7 count input or CH2 reset input.

(Note 2): Only F1 (DMV) instruction can perform the reading and writing of elapsed value area.

■ About max. count speed

The max. count speed indicates the situation when executing each item condition (output mode, channel) only. It indicates the value when not performing high-speed counter consistent ON (F166) instruction, high-speed counter consistent OFF (F167) instruction, pulse output function and other interruption handling control. For the performance when these functions are used concurrently, please contact us.

23.1.4 Type of Input Mode

■ Input mode and count operation

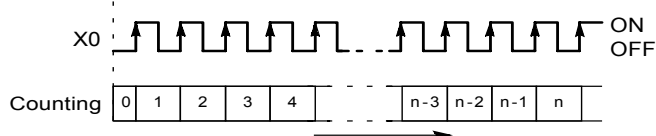
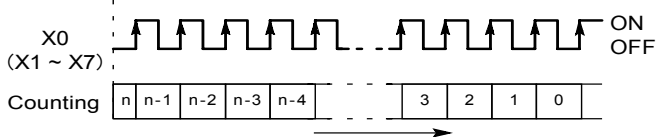
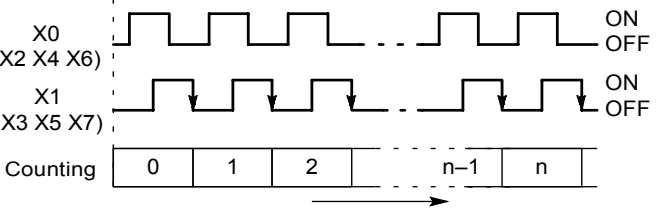
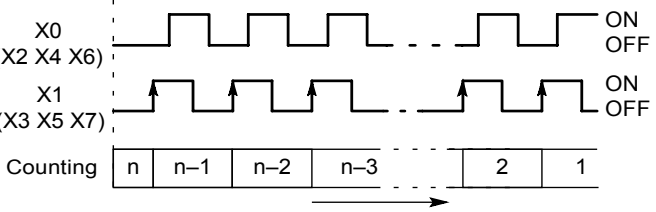
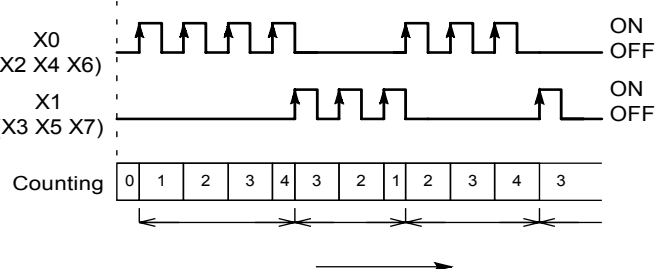
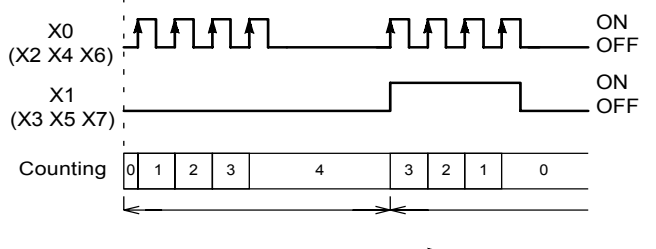
Mode	Scope
Addition input	 <p>X0 ON OFF</p> <p>Counting 0 1 2 3 4 ... n-3 n-2 n-1 n</p>
Subtraction input	 <p>X0 ON OFF</p> <p>(X1 ~ X7)</p> <p>Counting n n-1 n-2 n-3 n-4 ... 3 2 1 0</p>
2-phase input	 <p>X0 ON OFF</p> <p>(X2 X4 X6)</p> <p>X1 ON OFF</p> <p>(X3 X5 X7)</p> <p>Counting 0 1 2 ... n-1 n</p>
	 <p>X0 ON OFF</p> <p>(X2 X4 X6)</p> <p>X1 ON OFF</p> <p>(X3 X5 X7)</p> <p>Counting n n-1 n-2 n-3 ... 2 1</p>
Individual input	 <p>X0 ON OFF</p> <p>(X2 X4 X6)</p> <p>X1 ON OFF</p> <p>(X3 X5 X7)</p> <p>Counting 0 1 2 3 4 3 2 1 2 3 4 3</p>
Direction detection input	 <p>X0 ON OFF</p> <p>(X2 X4 X6)</p> <p>X1 ON OFF</p> <p>(X3 X5 X7)</p> <p>Counting 0 1 2 3 4 3 2 1 0</p>

23.1.5 Minimum Input Pulse Width

For cycle T , below input pulse width is needed as a minimum.

■ **Min. input pulse width**

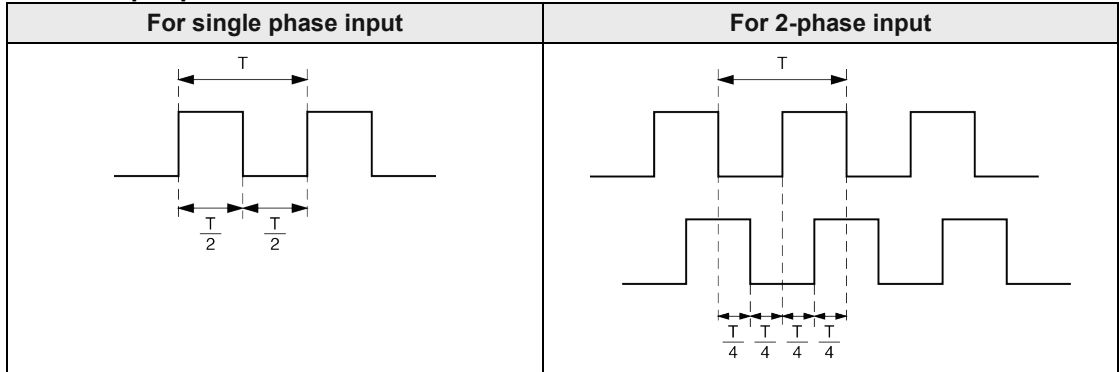

23.2 Settings of the System Registers

23.2.1 Settings of System Registers

Functions are allocated in system register setting dialog box as below. Explain it as below assuming that the FPWIN GR7 has been started.



◆ PROCEDURE

1. In the menu bar, select "Options"→"System Register Settings".
The "PLC Configuration" dialog box is displayed.
2. Select "Controller input settings 1 (HSC)" or "Controller input settings 2 (HSC)" from the left pane.

The setting menus of system register "No.400" or "No.401" display.

3. Change the setting of the channel which uses high-speed counter.

Below is the situation when 2-phase input (X0, X1) is allocated in CH0.

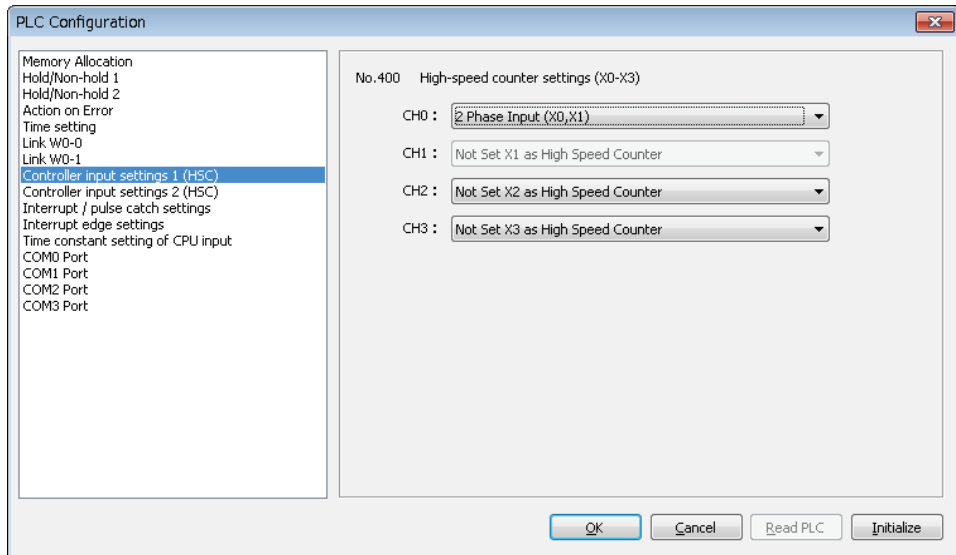

4. Click the [OK] button.

Return to the Edit screen of the ladder diagram. You can download Settings, program, and notes to PLC.

■ High-speed counter output related system register

Type	No. and Setting Items	Settings	
Controller input settings 1 (HSC)	400 High-speed counter settings (X0-X3)	CH0	Select any one of + count input (X0), - count input (X0), 2-phase input (X0, X1), individual input (X0, X1) and direction detection input (X0, X1).
		CH1	Select any one of + count input (X1) and - count input (X1).
		CH2	Select any one of + count input (X2), - count input (X2), 2-phase input (X2, X3), individual input (X2, X3) and direction detection input (X2, X3).
		CH3	Select any one of + count input (X3) and - count input (X3).
Controller input settings 2 (HSC)	401 High-speed counter settings (X4-X7)	CH4	Select any one of + count input (X4), - count input (X4), 2-phase input (X4,X5), individual input (X4, X5) and direction detection input (X4, X5).
		CH5	Select any one of + count input (X5) and - count input (X5).
		CH6	Select any one of + count input (X6), - count input (X6), 2-phase input (X6, X7), individual input (X6, X7), direction detection input (X6, X7).
		X6	When using external reset input, select the reset input of high-speed counter CH0.
		CH7	Select any one of + count input (X7) and - count input (X7).
		X7	When using external reset input, select the reset input of high-speed counter CH2.

(Note 1): The project name and range displayed vary with the model of control units.

(Note 2): The input not used in high-speed counter function selects "XX not act as high-speed counter for setting".

23.3 General-purpose Input / High-speed Counter Related Instruction

23.3.1 [F0 MV] High-speed counter control instruction

Perform controls such as software reset, count disabling, high-speed counter instruction clear.

■ Instruction format

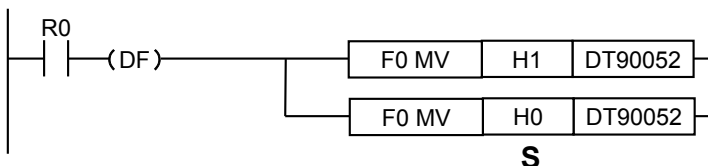

■ Operand

Operand	Settings
S	The area or constant data in which high-speed counter control code is saved.

■ Memory area type that can be specified (A: Available)

Operand	WX	WY	WR	WL	SV	EV	DT	LD	I	Constant		Index modifier
										K	H	
S	A	A	A	A	A	A	A	A	A	A	A	A

■ Operation description

- Perform high-speed counter control which corresponds to the control code designated by "S".
- This instruction is used when high-speed counter performs below operation.
 - ① Software reset, ② count is disabled, ③ External input makes reset input invalid, ④ When the control executed by high-speed counter instruction F166 - F167 is canceled, clear target value is interrupted.
- Once the control code is written, it will maintain till next writing.
- Control code written via F0 (MV) instruction is also saved to control code monitoring area when written in special register DT90052. Only lower 8 bits are written.

■ Precautions for programming

- The setting which is reset input invalid will become valid only when system register is used to allocate reset input.
- The external reset input setting can be used to switch the reset input (X6 or X7) allocated to mainframe input to valid or invalid.

■ **Control code allocation**

- Below bits are allocated according to designated channel and function.

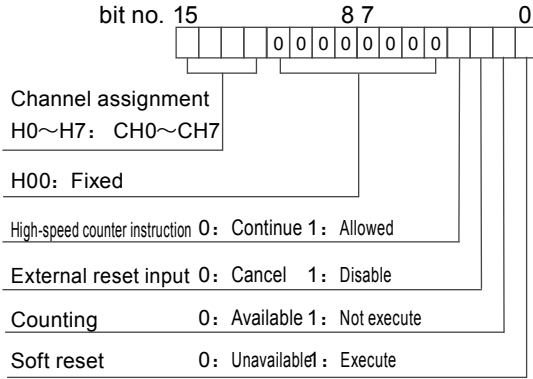

- Assign any input by controlling the above functions via the external input.

■ **Sample program**

Below shows the situation in which input X7 is used to perform the software reset of high-speed counter CH0.

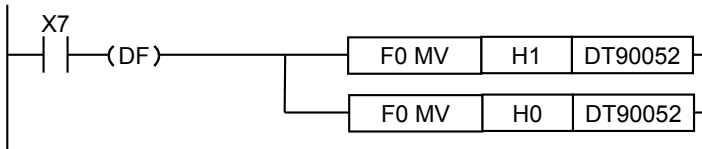

23.3.2 [F1 DMV] Elapsed value read and write instruction

Perform read and write of high-speed counter elapsed value.

■ Instruction format

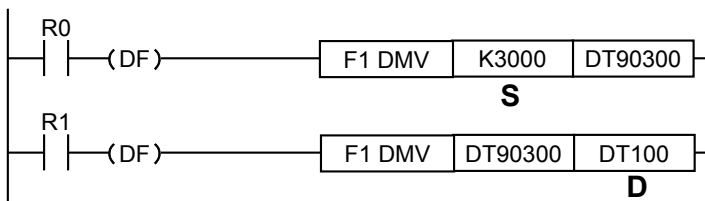

■ Operand

Operand	Settings
S	During setting: save the area or constant data of elapsed value (32 bit) which is set in high-speed counter. K-2, 147, 483, 648-K2, 147, 483, 647
D	During reading: read the area of high-speed counter elapsed value.

■ Memory area type that can be specified (A: Available)

Operand	WX	WY	WR	WL	SV	EV	DT	LD	I	Constant		Index modifier
										K	H	
S	A	A	A	A	A	A	A	A	A	A	A	A
D	-	A	A	A	A	A	A	A	A	-	-	A

■ Operation description (elapsed value reading)

- Save the contents of the special data register in which high-speed counter elapsed value is saved to the area which is designated by D.

■ Operation description (elapsed value setting)

- When writing to elapsed value area of high-speed counter in which 32 bit data is designated by S, use high-speed counter elapsed value area to perform setting inside the system.

■ Precautions for programming

- Only F1 (DMV) instruction can be written. Transmit instruction F0 (MV) and other application instructions such as arithmetic cannot be written.
- Please use lower 16 bit memory area No. to designate the memory area of "S" or "D".

23.3.3 [F166 HC1S] High-speed counter target value consistent ON instruction [F167 HC1R] High-speed counter target value consistent OFF instruction

When the high-speed counter elapsed value is consistent with the target value of operand setting, set the designated output to ON or OFF.

■ Instruction format

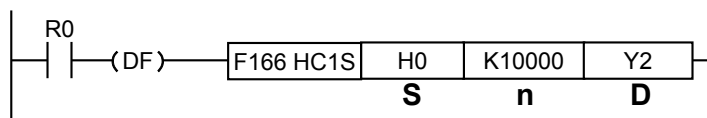

■ Operand

Operand	Settings
S	The high-speed counter channel number which acts as consistent output object
n	Start number of the area in which high-speed counter's target value data or data is saved
D	The output coil of ON or OFF in case of consistency (Y0 - Y29F)

■ Memory area type that can be specified (A: Available)

Operand	WX	WY	WR	WL	SV	EV	DT	LD	I	Constant		Index modifier
										K	H	
S	-	-	-	-	-	-	-	-	-	A	A	-
n	A	A	A	A	A	A	A	A	A	A	A	A
D	-	-	-	-	-	-	-	-	-	-	-	-

■ Operation description

- The value designated by [S] is set to high-speed counter's target value, when elapsed value is consistent to target value, control designates the output [Yn]. This will be executed by interruption handling.
- [F166 HC1S] During instruction, set output OFF->ON; during [F167 HC1R] instruction, set the output ON->OFF.
- When executing instruction, S value is saved to target value area.
- When the target value setting is consistent to target value, output control is cleared to zero when target value is consistent.
- When the target value is consistent, reset ON/OFF output, please use RST instruction, F0 (MV) instruction for resetting, or F166 (HC1S) instruction, F167 (HC1R) instruction to match the use.

■ **Sample program**

When the elapsed value of high-speed counter CH0 is consistent with K10000, below is the situation for setting output Y0.

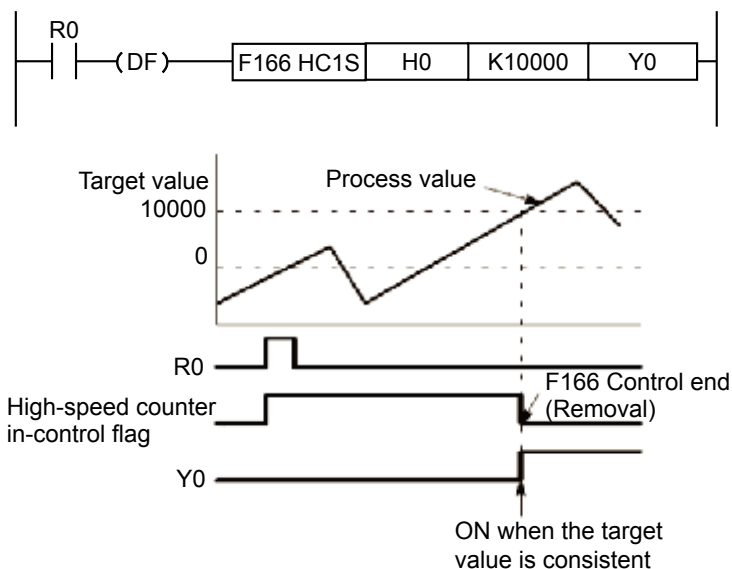

■ **Precautions for programming**

- After the instruction's execution condition turns to ON, high-speed counter In-control flag (R9110 - R9117) will be ON until the target value is consistent. The high-speed counter for the same channel cannot execute instruction (F166 - F167).
- Before being consistent with the target value, during hardware reset, elapsed value is reset to 0, but the setting of the target value and target value being consistent will not reset to zero.
- For the output Y designated when target value has consistent output, do not perform dual-output check for OT instruction, KP instruction and other application instruction.
- When in common program and interruption program, the same channel is described, do not execute them at the same time.

23.3.4 Interruption program startup when target value has consistent control

After [F166 HC1S] instruction, [F167 HC1R] instruction combined with interruption program, when the target values are consistent, you can startup interruption program.

■ **Execute method**

- Use system register to set high-speed counter. No need to set interruption input.
- Compile interruption program as secondary program.
- With the ICTL instruction in the main program, the corresponding interruption program is allowed to execute.
- Execute [F166 HC1S] instruction and [F167 HC1R] instruction. If high-speed counter's elapsed value is consistent with target value, the interruption program will startup.

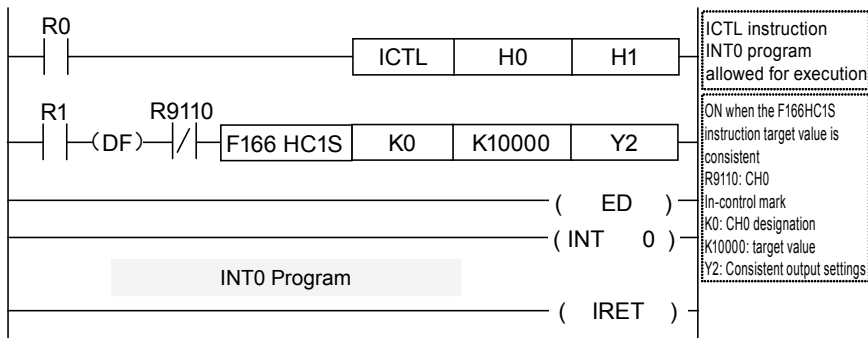

■ **Matching of channel number and interruption program number**

Channel number	INT No	Channel number	INT No
CH0	INT0	CH4	INT4
CH1	INT1	CH5	INT5
CH2	INT2	CH6	INT6
CH3	INT3	CH7	INT7

23.4 Sample Program

23.4.1 Running of the position control which has used inverter (1 speed)

Use the high-speed counter to perform counting for feedback signal of the encoder. When the count value reaches 5000, stop the inverter.

■ Wiring example

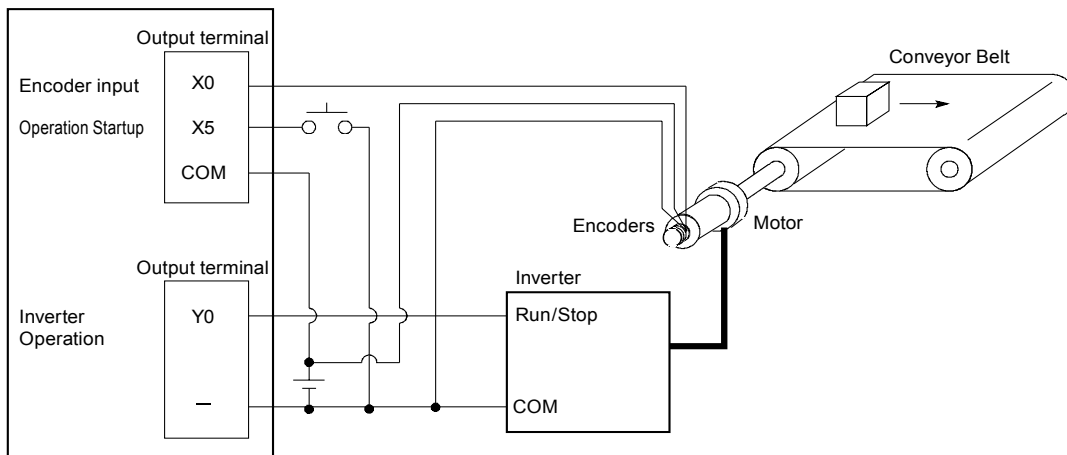

■ Operation diagram

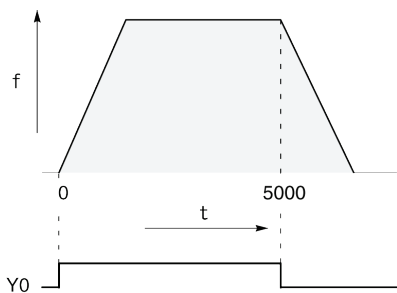

■ I/O allocation sheet

I/O Number	Contents	I/O Number	Description
X0	Encoder input	R100	Position control operation
X5	operation startup signal	R101	Position control operation startup
Y0	Frequency converter operation signal	R102	Position control end pulse
		R9110	High-speed counter CH0 in-control flag

■ Sample program

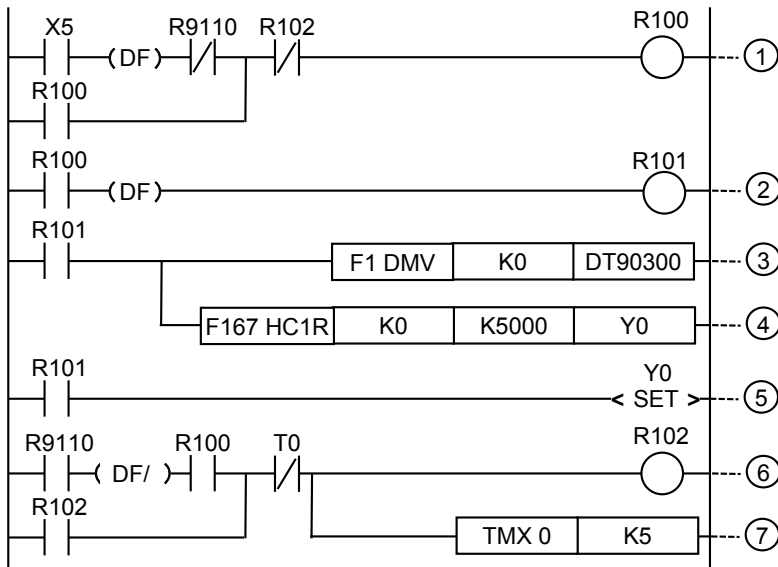

①	Position control operation
②	Position control operation startup
③	Value through which high-speed counter CH0 passes being reset
④	Target value consistent OFF instruction: when high-speed counter's elapsed value reaches 5000 pulse, Y0 becomes OFF.
⑤	Setting inverter operation signal Y0
⑥	Position control end pulse (0.5 s)
⑦	Use 0.1 s timer, setting 0.5 s

23.4.2 Running of the position control which has used inverter (2 speed)

Use the high-speed counter to perform counting for feedback signal of the encoder. When the count value reaches 4500, switch inverter to low speed operation. When the count value reaches 5000, stop the inverter.

■ Wiring example

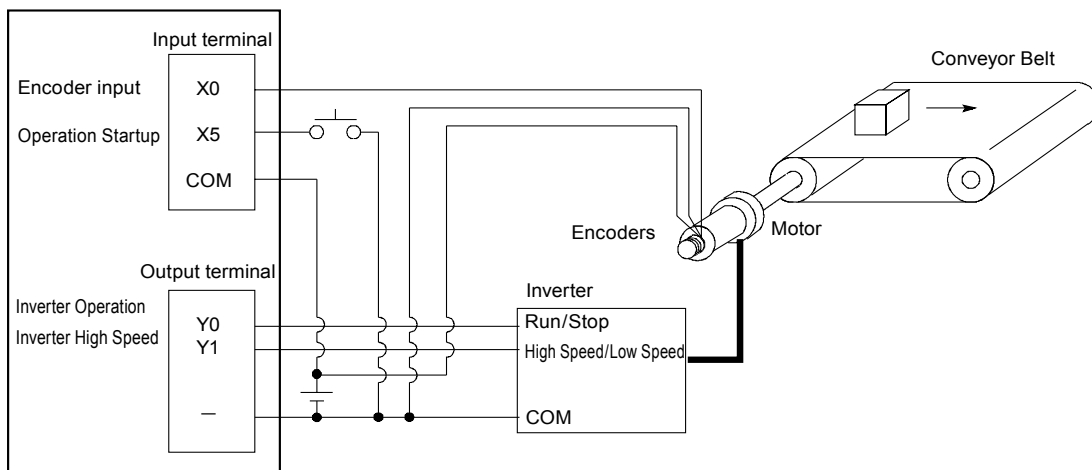

■ Operation diagram

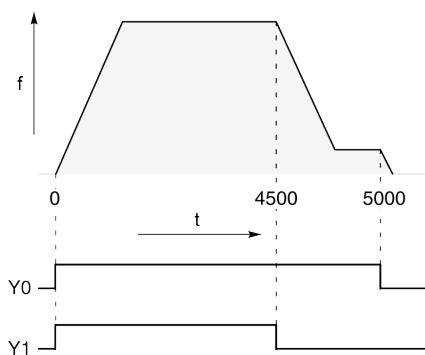

■ I/O allocation sheet

I/O Number	Contents	I/O Number	Description
X0	Encoder input	R100	Position control operation
X5	operation startup signal	R101	Reach deceleration point
Y0	Frequency converter operation signal	R102	Position control operation startup
Y1	Frequency converter high speed signal	R103	Position control end pulse
		R900C	Compare instruction < flag
		R9110	High-speed counter CH0 in-control flag

■ Sample program

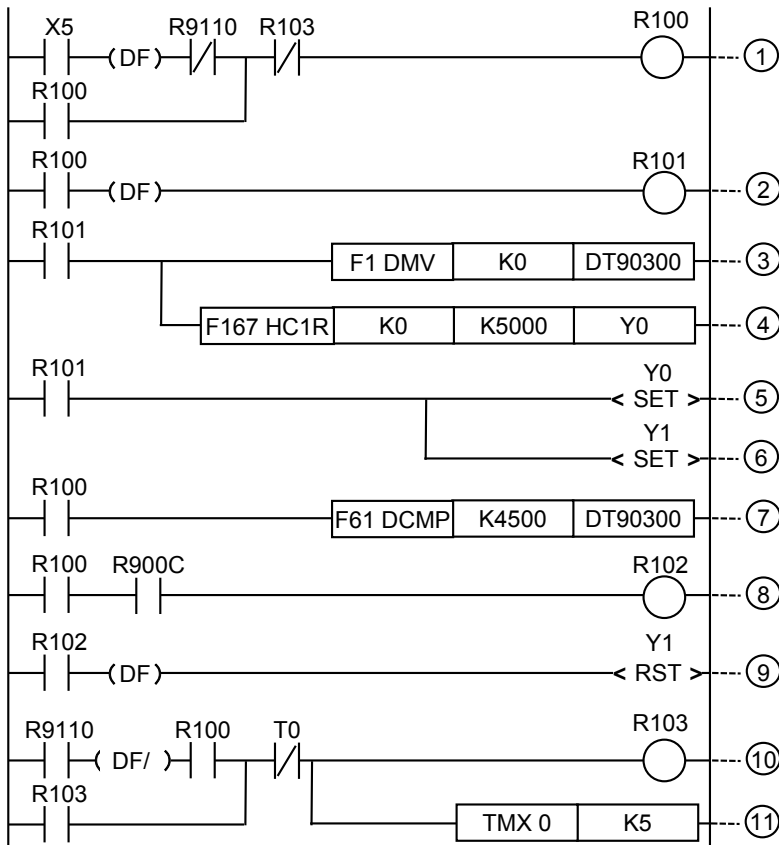

①	Position control operation
②	Position control operation startup
③	Value through which high-speed counter CH0 passes being reset
④	Target value consistent OFF instruction: high-speed counter CH0's elapsed value reaches 5000 pulse, Y0 changes to OFF.
⑤	Setting Y0 (inverter operation signal)
⑥	Setting Y1 (inverter high speed signal)
⑦	32 bit data compare instruction: when high-speed counter CH0's elapsed value exceeds 4500 pulse, R900C becomes ON.
⑧	Reach deceleration point
⑨	Reset Y1 (inverter high speed signal)
⑩	Position control end pulse (0.5 s)
⑪	0.1 s timer: setting K5, used as 0.5 s timer

24

Other Functions

24.1 Analog Potentiometer

24.1.1 Outline of Function

■ Outline of function

- The FP-XH M8N control unit equipped with an analog potentiometer.
- When rotating the potentiometer, the value of the special data register DT90040 changes between K0 - K4000. The set values inside the PLC can be changed without using a programming tool, therefore, it can be used to analog timers that change the set values by external rotary potentiometer.

24.1.2 Analog Potentiometer Application Examples

■ Timer application examples

The value of the special data register (DT90040) corresponding to the analog potentiometer V0 is transmitted to the set value area (SV0) of TMX0, and the timer time is set.

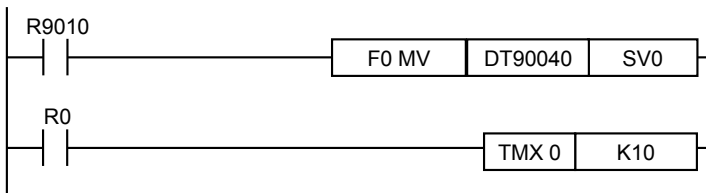

24.2 Input Time Constant Setting Function

24.2.1 Outline of Function

■ Actions when setting the input time constant processing

It is easy to set the time constant of the control unit input after changing the values of the system registers 430 - 431 with the programming tool.

If this setting is carried out, it will run in accordance with the following equivalent circuit. Once set, you can remove the input interference and vibration.

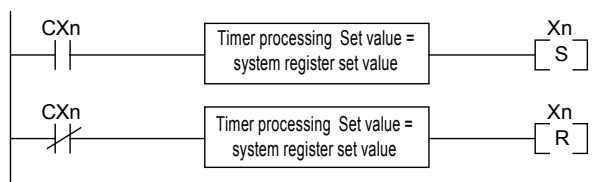

CXn=Xn contact input signal

Xn=input Xn image memory



◆ NOTES

- Receiving an input signal of the X contact can be performed by the common I/O refresh time.
- For the input in the time constant processing, such as executing part of the refresh instructions, the time constant processing is invalid, and the input status at this time is read out for setting.
- If use the F182 (FILTR) instruction, the time constant processing can be set even for the input outside the control unit (expansion unit).
- Using the time processing in the equivalent circuit requires no time instruction.
- For the setting to interrupt the high-speed counter or pulse catch, the time constant processing is ineffective.

■ Input time constant setting function and applicable models

System register number	Control unit controller I/O number	Applicable models
430	X0 - X3	○
431	X4 - X7	○

25

Maintenance and Inspection

25.1 Precautions for Using Backup Battery

25.1.1 Backup Battery Replacement

You can replace the backup battery of the FP-XH M8N control unit when the power is on. Please replace the backup battery according to the following steps.

 WARNING	Do not use batteries other than FPXHBATT. Failure to do so may result in an electric shock.
--	--

■ **Backup battery type (sold separately)**

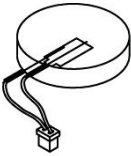
Appearance	Product Name	Specification	Product no.
	Backup battery for FP-XH	With connector	AFPXHBATT

■ **Number of installed batteries**

For FP-XH M8N control unit, only one battery can be installed.



◆ **PROCEDURE**

1. **Power up the controller unit for more than five minutes.**
When replacing the battery, charge up the built-in capacitor to maintain the memory contents.
2. **Turn the power off.**
3. **Open the cover.**
4. **Remove the used batteries.**
5. **Install the new battery within 2 minutes after cutting off the power supply.**
6. **Close the cover.**



◆ **KEY POINTS**

- **You can replace the battery of the FP-XH M8N control unit when the power is on. If you perform the replacement after cutting off the power, in order to charge up the built-in capacitor, power up for more than 5 minutes, and complete the replacement in less than 2 minutes. If the charging is not sufficient, it may lead to unstable clock/calendar data. When storing the battery connector cables, avoid them to be clapped into the cassette cover.**

25.1.2 Backup Battery Lifetime and Replacement Time

■ Backup Battery Lifetime

Master memory cassette	Type of Control Unit	Backup Battery Lifetime	Remarks
If installed	M8N	More than 5 years	Run 8 hours per day
If not installed			

(Note): Please notice that the service life may be reduced due to use conditions.

■ Backup battery abnormality detection and battery replacement time

- If the battery voltage drops, special internal relays (R9005, R9006) will turn to ON. Develop an program to send an outside abnormal warning as needed.
- If the system register No. 4 "Alarm Battery Error" setting is effective, the ERR.LED of the controller unit controller will flash.
- After the backup battery error is detected, the data can be maintained for about one week without power. However, please replace the battery immediately.



◆ NOTES

- When special internal relays (R9005, R9006) are ON or the ERR.LED of the control unit is flashed, if the power outage lasts a week, the data saved in the memory may be turned to 0.
- Special internal relays (R9005, R9006) are independent of the system register setting, if a backup battery error has been detected, it will turn to ON.
- Regardless of when the backup battery error was detected, power up the control unit for more than 2 minutes when replacing the backup battery.

25.2 Inspection

Perform routine or periodic inspection to ensure the best use conditions.

■ Check Items

Check Items	Check Contents	Determination Criteria	Related Page
Power supply	Verify the lighting state of the control unit RUN / PROG LED.	Normal if "Lit"	P.2-4
Status display LED display	Verify RUN mode LED display Verify the ERR.LED	Lit when in RUN status Normal if "Unlit"	P.2-4
Installation status	DIN rail installation, looseness Unit looseness and shaking	Required to be installed securely.	P.4-7 P.4-11
Connection status	Terminal screw looseness near to crimp terminals connector looseness	No looseness Fastened in parallel Locked. The connector shall be tight.	P.4-5 -P.4-10
Unit supply voltage	Voltage between terminals	24 VDC	P.2-6
Input and output circuit supply voltage	Supply voltage	24 VDC	P.2-7-P.2-8
Ambient environment	Ambient temperature, internal temperature ambient humidity, internal humidity environment	0-+55°C 10-95%RH There should be no dust and corrosive gas	P.4-2-P.4-3
Backup battery	Control unit backup battery	Periodic replacement	P.4-4 P.25-2-P.25-3

26

Specifications

26.1 Control Unit Specifications

26.1.1 General Specifications

■ General Specifications (AFPXHM8N16PD)

Item	Specification	
Operating ambient temperature	0 °C to +55 °C	
Storage ambient temperature	-40 °C to +70 °C	
Operating ambient humidity	10% to 95%RH (at 25 °C with no-condensing)	
Storage ambient humidity	10% to 95%RH (at 25 °C with no-condensing)	
Breakdown voltage (Detection current 5 mA)	Between power supply terminal and earth terminal	500V AC for 1 minute
	Between general-purpose input terminal and earth terminal	1500V AC for 1 minute
	Between general-purpose output terminal and earth terminal	500V AC for 1 minute
	Between pulse input terminal and earth terminal	500V AC for 1 minute
	Between RTEX (RJ45) connector and earth terminal	500V AC for 1 minute
Insulation resistance (Test voltage: 500V DC)	Between power supply terminal and earth terminal	100MΩ min.
	Between general-purpose input terminal and earth terminal	
	Between general-purpose output terminal and earth terminal	
	Between pulse input terminal and earth terminal	
	Between RTEX (RJ45) connector and earth terminal	
Vibration resistance	5 to 8.4 Hz, 3.5 mm single amplitude 8.4 to 150 Hz, acceleration of 9.8 m/s ² 10 sweeps each in X, Y and Z directions (1 octave/min.)	
Shock resistance	14. m/s ² min. In X, Y, and Z directions three times each	
Noise resistance	1,000 V[p-p], pulse width of 50 ns/1 μs (by noise simulator)	
Environment	Free from corrosive gases and excessive dust	
EC Directive applicable standard	EMC directive: EN 61131-2 and LVD: EN61131-2	
Overvoltage category	Category II or lower	
Pollution degree	Pollution degree 2 or lower	
Weight	Approx. 560g	

■ Current consumption list (AFPXHM8N16PD)

For 24 VDC
200 mA or less

26.1.2 Performance Specifications

Item		Specifications	
No. of control I/O points		General-purpose I/O part of the control unit: 16 points (DCinput: 8 points / Transistor output: 8 points) For E16 expansion I/O unit: up to 32 points For E30 expansion I/O unit: up to 256 points (up to 8 expansion units) For FP0R expansion I/O unit: up to 112 points (up to 3 expansion units)	
Program mode / Control method		Relay symbol / cyclic operation mode	
Program memory		Built-in Flash-ROM (requires no backup battery) Saved programs, system registers, position control data and position control data.	
Comments storage		All comments including I/O comments, explanatory notes, interlinear comments can be stored. (Backup battery is not necessary: 1M bytes)	
No. of instructions	Basic instructions	Approx. 120	
	High-level instructions	Approx. 230	
Program capacity		24k / 32k / 40k step (Note 1)	
Operation processing speed		Up to 7k steps: basic instruction 0.04 μ s - / step, high-level instruction 0.22 μ s - / step	
		Above 7k steps: basic instruction 0.7 μ s - / step, high-level instruction 1.73 μ s - / step	
IO refresh + base time		Single control unit: below .0.12 μ s For expansion unit E16: 0.34 ms \times No. of units For expansion unit E30: 0.47ms \times No. of units For expanded FP0 adapter: 1.4ms + FP0 expansion unit refresh time (note 2)	
Operation memory	Relay	External input (X)	2272 points (X0-X141F) (Note 3)
		External output (Y)	2272 points (Y0-Y141F) Not 3)
		Internal relay (R)	8192 points (R0-R511F)
		Special internal relay (R)	240 points
		Timer, counter (T / C)	1024 points (note 4) (Initial setting Timer 1008 points: T0-T1007, counter 16 points: C1008-C1023) Timer measurable up to (1msec/10msec/100msec/1sec units) \times 32767 Counter measures 1-32767
		Link relay (L)	2048 points (L0 - L127F)
	Memory area	Data register (DT)	64k, 32k, 12k words (Note 1)
		Link data register (LD)	256 words (LD0 - LD255)
		Index register (I)	14 words (I0 - ID)
	Differential points (DF, DF /, DF1)		Program capacity
Master control relay points		256 points	
No. of labels (JMP+LOOP)		256 points	
No. of step ladders		1000 steps	
No. of subroutines		500 subroutines	

(Note 1): When changing the system register No.0 (sequence program capacity setting), the data register (DT) capacity will also change.

(Note 2): Refresh time of FP0 expansion unit: No. of 8-point units used \times 0.8 msec, No. of 16-point units:used \times 1.0 msec, No. of 32-point units used \times 1.3 msec, No. of 64-point units used \times 1.9 msec

(Note 3): The number of points in the above table is the number of points of operation memory.. The actual number of points for input and output is determined by the combination of hardware.

(Note 4): The number of timer points can be changed by the setting of the system register no. 5. Points can be increased with the auxiliary timer.

Specifications

Item		Specifications
Interrupt program		Interruption via external input or interruption when the target value of the high-speed counter is consistent × 8 programs Periodical interrupt (0.1 ms unit, 0.5 ms unit or 10 ms unit) × 1 program
Sampling trace		Smapping by commands/Sampling at regular time intervals For one sampling: 16 bits + +3 words, 1000 samples)
PLC link function		Up to 16 units, (link relay 1024 points, link register 128 words) × 2. (Baud rate: 115200 bps / 230400 bps)
Constant scan		Available (0 msec-350 msec)
Security Function		Passwords (4-digit, 8-digit, 32-digit), upload protection
Self-diagnosis function		Watchdog timer, program syntax check
Rewriting during RUN		Available (Download during RUN, Program rewrite during RUN (Max. 512 steps)
High-speed counter	Controller input	Single-phase 8ch or 2-phase 4-ch Max. 10 kHz
	When pulse I/O cassette is installed	Can not be installed
Pulse output / PWM output	Controller output	None
	When pulse I/O cassette is installed	Can not be installed
Pulse catch input interrupt input		8 points (Input of main unit: 8 points)
Periodical interrupt		0.1ms-0.3s (0.1ms unit), 0.5ms-1.5s (0.5ms unit), 10ms-30s (10ms unit)
Potentiometer input		1ch (K0 - K4000)
Input time constant processing		Available (set via system register or instructions)
Calendar timer (real-time clock) (note 5)		Year (last 2 numbers in the Gregorian calendar), month, day, hour (24h), minute, second, week. As of 2099. Applicable during leap years. Available only when the master memory cassette AFPX-MRTC and battery are installed
Flash-ROM backup		Guaranteed writing times: up to 10 thousand times
		Automatic backup in case of power outage Counter 16 points, internal relay 128 points, data register 315 words
		Can be operated through the tool software or F-ROM read and write instruction (F12 / P13) Backup in data register 2K words
Battery backup		When optional batteries are used, all memory areas for operation can be backed up The hold / non-hold area can be set with the system register.
Battery lifetime		More than 5 years depending on the actual use condition (run 8 hours per day) (note 7)

(Note5): Precision of calendar timer (realtime clock) (At 0 degree: less than 119 seconds per month, At 25 degrees: less than 51 seconds per month, At 55 degrees: less than 148 seconds per month)

(Note 6): It will be cleared upon connection of the power if no battery installed or the battery is empty.

(Note 7): The battery life is the value with the power supply not connected. The actual service life may be reduced due to use conditions.

26.1.3 Performance Specifications of Motion Control Part

Item		Specifications		
Number of axes controlled		8 axes: Select from the following. 8 real axes, 7 real axes + 1 virtual axis, 6 real axes + 2 virtual axes		
Interpolation control		2-axis linear interpolation control, 2-axis arc interpolation control, 3-axis linear interpolation control and 3-axis spiral interpolation control.		
Automatichi operation	Position Control	Position setting mode	Absolute, increment	
		Position setting unit	pulse μm (Min. unit of instruction selectable between 0.1 μm and 1 μm) inch (Min. unit of instruction selectable between 0.00001 inch and 0.0001 inch) degree (Min. unit of instruction selectable between 0.1 degree and 1 degree)	
		Position setting range	pulse: - 2,147,482,624-2,147,482,624 pulse μm(0.1 μm): - 214,748,262.4-214,748,262.4 μm μm(1 μm): - 2,147,482,624-2,147,482,624 μm inch(0.00001 inch): - 21,474.82624-21,474.82624 inch inch(0.0001 inch): - 214,748.2624-214,748.2624 inch degree(0.1 degree): - 214,748,262.4-214,748,262.4 degree degree(1 degree): - 2,147,482,624-2,147,482,624 degree	
		Speed reference range	pulse:1-2,147,482,624 pps μm:1-2,147,482,624 μm/s inch:0.001-2,147,482.624 inch/s degree:0.001-2,147,482.624 rev/s	
		Acceleration and deceleration method	Linear acceleration/deceleration, S shape acceleration/deceleration	
		Acceleration time	0 - 10,000 ms (Settable by 1 ms)	
		Deceleration time	0 - 10,000 ms (Settable by 1 ms)	
		No. of positioning tables	Each axis: 600 points in standard area and 89 points in extended area	
		Control method	Independent	PTP control (E-point control, C-point control), CP control (P-point control), JOG positioning control (J-point control)
			2-axis linear interpolation	E point, P point, C point controls, Composite speed or Long axis speed
			2-axis circular interpolation	E point, P point, C point controls, Center point or Pass point
			3-axis linear interpolation	E point, P point, C point controls, Composite speed or Long axis speed
			3-axis spiral interpolation	E point, P point, C point controls, Center point or Pass point
		Startup time	Standard area: 3 ms or less, Extended area: 5 ms or less	
Other functions	Dwell time: 0-32,767ms (Settable by 1 ms)			

Specifications

Item		Specifications	
Synchronous operation	No. of axes	No. of synchronous groups	4 groups
		Master axis	Selectable from real axes, virtual axes and pulse inputs.
		Slave axis	Max. 8 axes per master axis
	Electronic gear	Operation setting	Gear ratio setting
		Operation method	Direct method, linear acceleration/deceleration method
	Electronic clutch	Trigger type	Clutch ON trigger: Contact method, Clutch OFF trigger: Contact input, The contact input +phase specification contact method can be selected from the edge and level types.
		Connection method	Direct method, linear slide method
	Electronic cam	Cam pattern	Select from 20 types. Multiple curves can be specified within phase (0 to -100%)
		Resolution	1024, 2048, 4096, 8192, 16384, 32768
		No. of cam patterns	4-16 (According to resolution)

Item		Specifications	
Manual operation	JOG operation	Speed reference range	Pulse: 1-2,147,482,624 pps μm: 1-2,147,482,624 μm/s inch: 0.001-2,147,482.624 inch/s degree: 0.001-2,147,482.624 rev/s
		Acceleration/deceleration method	Linear acceleration/deceleration, S acceleration/deceleration
		Acceleration time	0-0,000ms (Settable by 1 ms)
		Deceleration time	0-10,000ms (Settable by 1 ms)
	Home return	Speed reference range	pulse: 1-2,147,482,624 pps μm: 1-2,147,482,624 μm/s inch: 0.0010-2,147,482.624 inch/s degree: 0.001-2,147,482.624 rev/s
		Acceleration/deceleration method	Linear acceleration/deceleration
		Acceleration time	0-10,000 ms (Settable by 1 ms)
		Deceleration time	0-10,000 ms (Settable by 1 ms)
		Return method	DOG method (3 types), Limit method (2 types), Data set method, Z phase method, Stop-on-contact method (2 types)
	Pulsar operation (Note 1)	Number of channels	Max. 4 channels (Used in combination with the high-speed counter function.)
		Speed reference range	Operates synchronously with pulsar input. (Note 1)
	Stop function	Stop operation type	System stop, emergency stop, limit stop, error stop, deceleration stop, pause
		Stop deceleration time	The system stops when the deceleration time of all axes reaches 1 ms. The deceleration time of emergency stop, limit stop, error stop, deceleration stop and pause is 0 to 10,000 ms. (Settable by 1 ms.)
High-speed counter function (Note 1)	Number of channels	Max. 4 channels (Used in combination with the pulsar input.)	
	Counting range	Counting range: -2,147,483,648 - 2,147,483,647 pulses	
	Input mode	Phase difference input, Direction discrimination input, Individual input (transfer multiple available for each.)	
Memory backup		Parameters and positioning data are saved in the flash memory. (Batteryless)	
Other functions		Software limit, current value update, target speed change, target position change, tool operation, torque monitor, actual speed monitor, torque limit, AMP parameter R/W, AMP status monitor, RTEX general-purpose monitor input (max. 2 points), RTEX operation output (max. 2 points)	

(Note 1): The pulsar input function and high-speed counter function use the same pulse input terminal. Therefore, the both functions cannot be used simultaneously.

26.2 Communication Specifications

26.2.1 Communication Specifications of Control Unit

■ USB port (for tool software)

Item	Specifications
Specification	USB2.0 Fullspeed
Communication function	MEWTOCOL-COM (slave)
Connector shape	USB miniB type

■ COM0 port

Item	Specifications
Interface	Three-wire RS-232C x 1 channel
Transmission distance	15 m (Note 1)
Baud rate	2400, 4800, 9600, 19200, 38400, 57600, 115200, 230400 bit / s
Communication method	Half-duplex transmission
Synchronous method	Start stop synchronous system
Communication format	Data length: 7 bits/8 bits, Stop bit: 1 bit/2 bits, Parity: None/Odd/Even Start code: STX/No STX, End code: CR/CR+LF/None/ETX
Data transmission order	Transmits from bit 0 character by character.
Communication functions	PLC link MEWTOCOL-COM (Master/Slave) MODBUS RTU (Master/Slave) General-purpose communication Modem initialization

(Note 1) When communication is performed at a baud rate of 38400 bit/s or higher, use the cable not longer than 3 m. For wiring the RS232C, a shielded wire must be used to increase noise suppression.

■ Communication specifications of motion control part

Item	Specifications
Physical layer	100BASE-TX (IEEE802.3)
Baud rate	100 Mbps
Transmission distance	Between nodes: Max. 100 m, Total length: Max. 200 m
Topology	Ring
Applicable cable	STP cable (category 5e or higher)
Connector	9-pin RJ45 x 2
Communication cycle	0.5 ms
Position command update	1 ms
No. of connected slaves	Max. 8 slaves
Coonnected slave	Panasonic AC Servo Motor A6N series/A5N series

26.2.2 Specifications of Communication Cassette

■ RS-232C / RS-422 / RS-485 interface

Item	Specifications				
	AFPX-COM1 AFPX-COM5	AFPX-COM2	AFPX-COM3	AFPX-COM4	AFPX-COM6
Interface	RS-232C x 1 ch (Note 1)	RS-232C (3-wire type) x 2 chs	RS-485/RS-422 x 1 ch (Note 2)(Note 3)	RS-485 x 1 ch, RS-232C (3-wire type) x 1 ch (Note 3)	RS-485 x 2 chs (Note 3)
Transmission distance	RS-232C: Max. 15 m (Note 4) When using RS-422: Max. 400 m When using RS-485: Max. 1,200 m (Note 5) (Note 6)				
Baud rate	2400, 4800, 9600, 19200, 38400, 57600, 115200, 230400 bit/s				
Communication method	Half-duplex transmission				
Synchronous method	Start stop synchronous system				
Communication format	Data length: 7 bits/8 bits, Stop bit: 1 bit/2 bits, Parity: None/Odd/Even Start code: STX/No STX, End code: CR/CR+LF/None/ETX				
Data transmission order	Transmits from bit 0 character by character.				
Communication function and no. of connected units	PLC link: Max. 16 units MEWTOCOL-COM (Master/Slave): Max. 99 units MODBUS RTU (Master/Slave): Max. 99 units General-purpose communication: Max. 99 units Modem initialization				

(Note 1): The AFPX-COM1 is a 5-wire type. When using it as a 3-wire type, short-circuit the RS-CS terminal.

(Note 2): It can be switched between RS-485 and RS-422 by switching the dip switches on the cassette.

(Note 3): When connecting a commercially available device that has an RS485 interface, please confirm operation using the actual device. In some cases, the number of units, transmission distance, and baud rate vary depending on the connected device.

(Note 4): When communication is performed at a baud rate of 38400 bit/s or higher, use the cable not longer than 3 m. For wiring the RS232C, a shielded wire must be used to increase noise suppression.

(Note 5): The transmission distance is limited by the baud rate and the number of connected units when setting RS-485 as follows. For the baud rate of 38400 bit/s or less, the distance is up to 1200 m, and the number of connected units is 99. When using in combination with the C-NET adapter, the maximum number of connected units is limited to 32, and the baud rate is limited to 19200 bit/s or less.

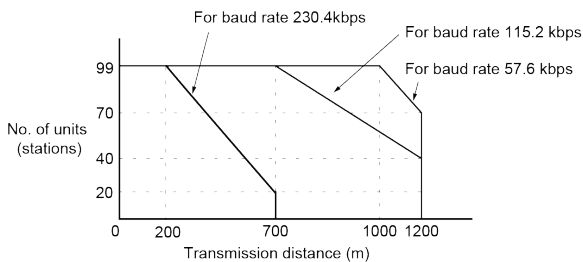

(Note 6): The converter SI-35 manufactured by Lineeye Co., Ltd. is recommendable for the RS-485 at the computer side.

(Note 7): For information on usable functions and restrictions on the combination, refer to 1.4.4 Restrictions on Communication Function.

■ Ethernet port

Item	Specifications	
	AFPX-COM5	
Interface	IEEE802.3u, 100BASE-TX / 10BASE-T	
Baud rate	100 Mbps, 10 Mbps (Note 1)	
Transmission system	Baseband	
Max. segment length	100 m (Note 2)	
Communication cable	UTP cable (Category 5)	
Communication protocol	TCP/IP, UDP/IP, ICMP, ARP, DHCP	
Functions	Auto-negotiation function MDI/MDI-X Auto-crossover function	
Communication functions	MEWTOCOL-COM (Master/Slave)	Max. 1 connection (Client) Max. 3 connections (Server)
	General-purpose communication	Max. 1 connection (Client)

(Note 1): Switching between different speeds is done automatically by auto negotiation function.

(Note 2): The standards cite 100 m as the maximum, but noise resistance measures such as attaching a ferrite core may be necessary in some cases, depending on the usage environment. Also, if the hub is positioned close to a control board, we recommend using it at a distance of 10 m or less.

26.3 Operation Memory Areas

■ List of operation memory areas

Item	Specifications	
Relays	External input (X) (note 1)	2272 points (X0 - X141F)
	External output (Y) (note 1)	2272 points (Y0 - Y141F)
	Internal relay (R)	8192 points (R0-R511F)
	Link relay (L)	2048 points (L0 - L127F)
	Timer / counter (T/C) (note 3)	1024 points (timer 1008 points: T0-T1007, counter 16 points: C1008-C1023) Timer measures (1msec/10msec/100msec/1sec units) × 32767 Counter measures 1-32767
	Special internal relay (R)	256 points (R9000 - R915F)
Memory area	External input (WX) (note 1)	142 words (WX0 - WX141)
	External output (WY) (note 1)	142 words (WY0 - WY141)
	Internal relay (WR)	512 words (WR0 - WR511) (note 2)
	Link relay (WL)	128 words (WL0 - WL127)
	Data register (DT)	65533 words (DT0-DT12284)/32765 words (DT0-DT32764)/12285 words (DT0-DT65532) (note 3)
	Special data register (DT)	500 words (DT90000 - DT90499)
	Link data register (LD)	256 words (LD0 - LD255)
	Timer/counter set value area (SV)	1024 words (SV0 - SV1023)
	Timer/counter elapsed value area (EV)	1024 words (EV0 - EV1023)
	Index register (I)	14 words (I0 - ID)
Constant	Decimal constant (K)	K-32,768 - K32,767 (16-bit operation) K-2,147,483,648 - K2,147,483,647 (32-bit operation)
	Hexadecimal constant (H)	H0-HFFFF (16-bit operation) H0-HFFFFFFF (32-bit operation)
	Floating-point type real numbers (f)	F-1.175494×10 ⁻³⁸ - F-3.402823×10 ³⁸ F 1.175494×10 ⁻³⁸ - F 3.402823×10 ³⁸

(Note 1): The number of points noted above is the number of points of operation memory. The number of points actually used as input/output is determined by the hardware configuration.

(Note 2): The number of timer/counter points can be changed by the setting of the system register no.5. Points can be increased with the auxiliary timer.

(Note 3): When changing the system register no.0 (sequence program capacity setting), the data register (DT) capacity will also change.

Program capacity	24K	32K	40K
Data register capacity	65533 words	32765 words	12285 words

(Note 4): For details on hold/non-hold area, refer to "21.1.2 Operation Memory Backup".

26.4 Positioning Memory

26.4.1 Entire Configuration of Positioning Memory

Positioning memory consists of 6 areas

Area no.0	Area name	Offset Address	Individual name of each area	
0	Common area	H85-H389	Setting parameter control area	
			Operation speed rate area	
			Axis group setting area	
			Current value update data area	
			Torque limit area	
			Positioning table setting area	
			Positioning control area	
			Error annunciation & clear area	
			Warning annunciation & clear area	
			Synchronous control monitor area	
			System operation setting area	
			AMP monitor & control area	
			Pulse input setting area	
			Pulse count control area	
Pulse input monitor area				
1	Each axis information area (Note)	H0-H3F	Axis 1	Each axis information & monitor area
			Axis 2	Each axis information & monitor area
			Axis 3	Each axis information & monitor area
			Axis 4	Each axis information & monitor area
			Axis 5	Each axis information & monitor area
			Axis 6	Each axis information & monitor area
			Axis 7 (virtual)	Each axis information & monitor area
			Axis 8 (virtual)	Each axis information & monitor area

Area no.0	Area name	Offset Address	Individual name of each area	
2	Each axis setting area	H0-H27FF	Axis 1	Parameter setting area
				Positioning data setting area (600 standard points and 89 expansion points)
			Axis 2	Parameter setting area
				Positioning data setting area (600 standard points and 89 expansion points)
			Axis 3	Parameter setting area
				Positioning data setting area (600 standard points and 89 expansion points)
			Axis 4	Parameter setting area
				Positioning data setting area (600 standard points and 89 expansion points)
			Axis 5	Parameter setting area
				Positioning data setting area (600 standard points and 89 expansion points)
			Axis 6	Parameter setting area
				Positioning data setting area (600 standard points and 89 expansion points)
			Axis 7 (virtual)	Parameter setting area
				Positioning data setting area (600 standard points and 89 expansion points)
			Axis 8 (virtual)	Parameter setting area
				Positioning data setting area (600 standard points and 89 expansion points)
3	Cam pattern editing area	H0-H5F	Cam pattern setting area	

Area no.0	Area name	Offset Address	Individual name of each area	
4	Synchronous control setting area	H0-H6F	Axis 1	Synchronous control common setting area
				Electronic gear setting area
				Clutch setting area
				Electronic cam setting area
			Axis 2	Synchronous control common setting area
				Electronic gear setting area
				Clutch setting area
				Electronic cam setting area
			Axis 3	Synchronous control common setting area
				Electronic gear setting area
				Clutch setting area
				Electronic cam setting area
			Axis 4	Synchronous control common setting area
				Electronic gear setting area
				Clutch setting area
				Electronic cam setting area
			Axis 5	Synchronous control common setting area
				Electronic gear setting area
				Clutch setting area
				Electronic cam setting area
			Axis 6	Synchronous control common setting area
				Electronic gear setting area
				Clutch setting area
				Electronic cam setting area
			Axis 7 (virtual)	Synchronous control common setting area
				Electronic gear setting area
				Clutch setting area
				Electronic cam setting area
Axis 8 (virtual)	Synchronous control common setting area			
	Electronic gear setting area			
	Clutch setting area			
	Electronic cam setting area			

Area no.0	Area name	Offset Address	Individual name of each area	
5	Positioning operation change area	H0-HF	Axis 1	Setting area
			Axis 2	Setting area
			Axis 3	Setting area
			Axis 4	Setting area
			Axis 5	Setting area
			Axis 6	Setting area
			Axis 7 (virtual)	Setting area
			Axis 8 (virtual)	Setting area
6	AMP parameter area	H0-H3F	AMP parameter setting area	



◆ NOTES

- Be sure not to execute writing in the reserved areas for the system.
- For reading each axis information area with the program, check if the link establishment annunciation flag (X1100) turns ON before reading it.

26.4.2 Common Area (Memory Area No.0)

■ Setting parameter control area

Offset Address	Name	Default	Description
H85	Recalculation starting table number	K1	When the recalculation request signal (Y1170) turns on, the control unit will recalculate the positioning data of all the axes from this table number to no. 600. Setting Range: K1-K600

■ Operation speed setting area

Offset Address	Name	Default	Description
H88	Operation speed rate	K100	All operations relating to axes (positioning, JOG, home return) can be performed at the specified rate. Setting Range: K1-K100 Unit: %

■ Axis group setting area

Offset Address	Name	Default	Description																																	
HB0	Group-A axis setting	H0	<p>Set either independent or interpolation for each axis in this area. In case of interpolation, each axis belongs to any group A to D. For example, the axes 1, 2 and 3 belong to group A and are 3-axis interpolation, set the corresponding 3 bits to 1 in the interpolation axis setting of group A.</p> <p>The max. number of interpolation in each group is 3, the same axis cannot be set repeatedly in different groups.</p> <table border="1"> <thead> <tr> <th>bit</th> <th>Name</th> <th>Default</th> <th>Description</th> </tr> </thead> <tbody> <tr> <td>0</td> <td>Group attribute of axis 1</td> <td>0</td> <td rowspan="8"> 0: Not belong to the interpolation group 1: Belong to the interpolation group. If there are over 4 bits in the group set to 1, or the same axis being set to 1 repeatedly in other groups, an error occurs. Also, an error occurs if an axis that has been set as a virtual axis by Configurator PM7 is set. </td> </tr> <tr> <td>1</td> <td>Group attribute of axis 2</td> <td>0</td> </tr> <tr> <td>2</td> <td>Group attribute of axis 3</td> <td>0</td> </tr> <tr> <td>3</td> <td>Group attribute of axis 4</td> <td>0</td> </tr> <tr> <td>4</td> <td>Group attribute of axis 5</td> <td>0</td> </tr> <tr> <td>5</td> <td>Group attribute of axis 6</td> <td>0</td> </tr> <tr> <td>6</td> <td>Group attribute of axis 7</td> <td>0</td> </tr> <tr> <td>7</td> <td>Group attribute of axis 8</td> <td>0</td> </tr> <tr> <td>15-8</td> <td>—</td> <td>—</td> <td>—</td> </tr> </tbody> </table>	bit	Name	Default	Description	0	Group attribute of axis 1	0	0: Not belong to the interpolation group 1: Belong to the interpolation group. If there are over 4 bits in the group set to 1, or the same axis being set to 1 repeatedly in other groups, an error occurs. Also, an error occurs if an axis that has been set as a virtual axis by Configurator PM7 is set.	1	Group attribute of axis 2	0	2	Group attribute of axis 3	0	3	Group attribute of axis 4	0	4	Group attribute of axis 5	0	5	Group attribute of axis 6	0	6	Group attribute of axis 7	0	7	Group attribute of axis 8	0	15-8	—	—	—
bit	Name			Default	Description																															
0	Group attribute of axis 1			0	0: Not belong to the interpolation group 1: Belong to the interpolation group. If there are over 4 bits in the group set to 1, or the same axis being set to 1 repeatedly in other groups, an error occurs. Also, an error occurs if an axis that has been set as a virtual axis by Configurator PM7 is set.																															
1	Group attribute of axis 2			0																																
2	Group attribute of axis 3			0																																
3	Group attribute of axis 4			0																																
4	Group attribute of axis 5			0																																
5	Group attribute of axis 6			0																																
6	Group attribute of axis 7	0																																		
7	Group attribute of axis 8	0																																		
15-8	—	—	—																																	
HB1	Group-B axis setting																																			
HB2	Group-C axis setting																																			
HB3	Group-D axis setting																																			
HB4	Independent axis setting	H0	<p>Please set the object bit to 1 for independent axis not belonging to the interpolation group.</p> <table border="1"> <thead> <tr> <th>bit</th> <th>Name</th> <th>Default</th> <th>Description</th> </tr> </thead> <tbody> <tr> <td>0</td> <td>Attribute of axis 1</td> <td>0</td> <td rowspan="8"> 0: Belong to the interpolation group, or not set as used axes. 1: Independent axis (not belonging to the interpolation group). An error may occur when setting the interpolation group. </td> </tr> <tr> <td>1</td> <td>Attribute of axis 2</td> <td>0</td> </tr> <tr> <td>2</td> <td>Attribute of axis 3</td> <td>0</td> </tr> <tr> <td>3</td> <td>Attribute of axis 4</td> <td>0</td> </tr> <tr> <td>4</td> <td>Attribute of axis 5</td> <td>0</td> </tr> <tr> <td>5</td> <td>Attribute of axis 6</td> <td>0</td> </tr> <tr> <td>6</td> <td>Attribute of (virtual) axis 7</td> <td>0</td> </tr> <tr> <td>7</td> <td>Attribute of (virtual) axis 8</td> <td>0</td> </tr> <tr> <td>15-8</td> <td>—</td> <td>—</td> <td>—</td> </tr> </tbody> </table>	bit	Name	Default	Description	0	Attribute of axis 1	0	0: Belong to the interpolation group, or not set as used axes. 1: Independent axis (not belonging to the interpolation group). An error may occur when setting the interpolation group.	1	Attribute of axis 2	0	2	Attribute of axis 3	0	3	Attribute of axis 4	0	4	Attribute of axis 5	0	5	Attribute of axis 6	0	6	Attribute of (virtual) axis 7	0	7	Attribute of (virtual) axis 8	0	15-8	—	—	—
bit	Name	Default	Description																																	
0	Attribute of axis 1	0	0: Belong to the interpolation group, or not set as used axes. 1: Independent axis (not belonging to the interpolation group). An error may occur when setting the interpolation group.																																	
1	Attribute of axis 2	0																																		
2	Attribute of axis 3	0																																		
3	Attribute of axis 4	0																																		
4	Attribute of axis 5	0																																		
5	Attribute of axis 6	0																																		
6	Attribute of (virtual) axis 7	0																																		
7	Attribute of (virtual) axis 8	0																																		
15-8	—	—	—																																	
HB5-HBF	Reserved for system	—	—																																	

■ Current value update area

Offset Address	Name	Default	Description																																	
HC0	Current value update request flag	H0	<p>Only when the bit corresponding to each axis changes to 1 from 0, the current values controlled by the control unit are changed to the following values.</p> <p>After the change, the control unit will automatically clear the corresponding bit.</p> <table border="1"> <thead> <tr> <th>bit</th> <th>Name</th> <th>Default</th> <th>Description</th> </tr> </thead> <tbody> <tr> <td>0</td> <td>Current value update request for axis 1</td> <td>0</td> <td rowspan="8">0: Unchanged 1: Update the current value of the object axis</td> </tr> <tr> <td>1</td> <td>Current value update request for axis 2</td> <td>0</td> </tr> <tr> <td>2</td> <td>Current value update request for axis 3</td> <td>0</td> </tr> <tr> <td>3</td> <td>Current value update request for axis 4</td> <td>0</td> </tr> <tr> <td>4</td> <td>Current value update request for axis 5</td> <td>0</td> </tr> <tr> <td>5</td> <td>Current value update request for axis 6</td> <td>0</td> </tr> <tr> <td>6</td> <td>Current value update request for (virtual) axis 7</td> <td>0</td> </tr> <tr> <td>7</td> <td>Current value update request for (virtual) axis 78</td> <td>0</td> </tr> <tr> <td>15-8</td> <td>—</td> <td>—</td> <td>—</td> </tr> </tbody> </table>	bit	Name	Default	Description	0	Current value update request for axis 1	0	0: Unchanged 1: Update the current value of the object axis	1	Current value update request for axis 2	0	2	Current value update request for axis 3	0	3	Current value update request for axis 4	0	4	Current value update request for axis 5	0	5	Current value update request for axis 6	0	6	Current value update request for (virtual) axis 7	0	7	Current value update request for (virtual) axis 78	0	15-8	—	—	—
			bit	Name	Default	Description																														
			0	Current value update request for axis 1	0	0: Unchanged 1: Update the current value of the object axis																														
			1	Current value update request for axis 2	0																															
			2	Current value update request for axis 3	0																															
			3	Current value update request for axis 4	0																															
			4	Current value update request for axis 5	0																															
			5	Current value update request for axis 6	0																															
			6	Current value update request for (virtual) axis 7	0																															
			7	Current value update request for (virtual) axis 78	0																															
15-8	—	—	—																																	
HC1-HC7	Reserved for system	—	—																																	
HC8-HC9	Current value update coordinate of axis 1	K0	Stores the coordinate value to be preset by the current value update function.																																	
HCA-HCB	Current value update coordinate of axis 2	K0																																		
HCC-HCD	Current value update coordinate of axis 3	K0																																		
HCE-HCF	Current value update coordinate of axis 4	K0																																		
HD0-HD1	Current value update coordinate of axis 5	K0																																		
HD2-HD3	Current value update coordinate of axis 6	K0																																		
HD4-HD5	Current value update coordinate for (virtual) axis 7	K0																																		
HD6-HD7	Current value update coordinate for (virtual) axis 8	K0																																		

■ Torque limit area

Offset Address	Name	Default	Description																																	
HD8	Torque limit enable flag	H0	Set whether to enable or disable the execution of the torque limit for each axis. For enabling the torque limit, set the corresponding bits to 1.																																	
			<table border="1"> <thead> <tr> <th>bit</th> <th>Name</th> <th>Default</th> <th>Description</th> </tr> </thead> <tbody> <tr> <td>0</td> <td>Torque limit of axis 1</td> <td>0</td> <td rowspan="8">0: Torque limit disabled (Default) 1: Torque limit enabled</td> </tr> <tr> <td>1</td> <td>Torque limit of axis 2</td> <td>0</td> </tr> <tr> <td>2</td> <td>Torque limit of axis 3</td> <td>0</td> </tr> <tr> <td>3</td> <td>Torque limit of axis 4</td> <td>0</td> </tr> <tr> <td>4</td> <td>Torque limit of axis 5</td> <td>0</td> </tr> <tr> <td>5</td> <td>Torque limit of axis 6</td> <td>0</td> </tr> <tr> <td>6</td> <td>Torque limit of axis 7</td> <td>0</td> </tr> <tr> <td>7</td> <td>Torque limit of axis 8</td> <td>0</td> </tr> <tr> <td>15-8</td> <td>-</td> <td>-</td> <td>-</td> </tr> </tbody> </table>	bit	Name	Default	Description	0	Torque limit of axis 1	0	0: Torque limit disabled (Default) 1: Torque limit enabled	1	Torque limit of axis 2	0	2	Torque limit of axis 3	0	3	Torque limit of axis 4	0	4	Torque limit of axis 5	0	5	Torque limit of axis 6	0	6	Torque limit of axis 7	0	7	Torque limit of axis 8	0	15-8	-	-	-
			bit	Name	Default	Description																														
			0	Torque limit of axis 1	0	0: Torque limit disabled (Default) 1: Torque limit enabled																														
			1	Torque limit of axis 2	0																															
			2	Torque limit of axis 3	0																															
			3	Torque limit of axis 4	0																															
			4	Torque limit of axis 5	0																															
			5	Torque limit of axis 6	0																															
			6	Torque limit of axis 7	0																															
7	Torque limit of axis 8	0																																		
15-8	-	-	-																																	
HC9-HDF	Reserved for system	-	-																																	
HE0	Torque limit value of axis 1	K3000	Set the torque limit value for each axis. Setting range: K1-K5000 Unit: 0.1 %																																	
HE1	Torque limit value of axis 2	K3000																																		
HE2	Torque limit value of axis 3	K3000																																		
HE3	Torque limit value of axis 4	K3000																																		
HE4	Torque limit value of axis 5	K3000																																		
HE5	Torque limit value of axis 6	K3000																																		
HE6	Torque limit value of axis 7	K3000																																		
HE7	Torque limit value of axis 8	K3000																																		

■ Positioning control starting table number setting area

Offset Address	Name	Default	Description
H100	Position control starting table number of axis 1	K1	Stores the position control starting table number. Setting range: 1-600, 10001-10089
H101	Position control starting table number of axis 2		
H102	Position control starting table number of axis 3		
H103	Position control starting table number of axis 4		
H104	Position control starting table number of axis 5		
H105	Position control starting table number of axis 6		
H106	Position control starting table number of (virtual) axis 7		
H107	Position control starting table number of (virtual) axis 8		

■ Positioning control area

Offset Address	Name	Default	Description
H108	Positioning repeat count of axis 1	K0	Stores the number of times for repeating the operation starting from the position control starting table number until the E point. When 255 is stored, the positioning control is repeated unlimitedly until the operation is stopped. Setting range: 0-255
H109	Positioning repeat count of axis 2		
H10A	Positioning repeat count of axis 3		
H10B	Positioning repeat count of axis 4		
H10C	Positioning repeat count of axis 5		
H10D	Positioning repeat count of axis 6		
H10E	Positioning repeat count of (virtual) axis 7		
H10F	Positioning repeat count of (virtual) axis 8		

■ Error annunciation & clear area

Offset Address	Name	Description																																	
H110	Reserved for system	-																																	
H111	Error clear individual axis setting	Executes the error clear for each axis.																																	
		<table border="1"> <thead> <tr> <th>bit</th> <th>Name</th> <th>Default</th> <th>Description</th> </tr> </thead> <tbody> <tr> <td>0</td> <td>Error clear for axis 1</td> <td>0</td> <td rowspan="9">0: Not clear errors 0 to 1: clear errors (After execution, the control unit will automatically change the value to 0.)</td> </tr> <tr> <td>1</td> <td>Error clear for axis 2</td> <td>0</td> </tr> <tr> <td>2</td> <td>Error clear for axis 3</td> <td>0</td> </tr> <tr> <td>3</td> <td>Error clear for axis 4</td> <td>0</td> </tr> <tr> <td>4</td> <td>Error clear for axis 5</td> <td>0</td> </tr> <tr> <td>5</td> <td>Error clear for axis 6</td> <td>0</td> </tr> <tr> <td>6</td> <td>Error clear for (virtual) axis 7</td> <td>0</td> </tr> <tr> <td>7</td> <td>Error clear for (virtual) axis 8</td> <td>0</td> </tr> <tr> <td>15-8</td> <td>—</td> <td>—</td> <td>—</td> </tr> </tbody> </table>	bit	Name	Default	Description	0	Error clear for axis 1	0	0: Not clear errors 0 to 1: clear errors (After execution, the control unit will automatically change the value to 0.)	1	Error clear for axis 2	0	2	Error clear for axis 3	0	3	Error clear for axis 4	0	4	Error clear for axis 5	0	5	Error clear for axis 6	0	6	Error clear for (virtual) axis 7	0	7	Error clear for (virtual) axis 8	0	15-8	—	—	—
		bit	Name	Default	Description																														
		0	Error clear for axis 1	0	0: Not clear errors 0 to 1: clear errors (After execution, the control unit will automatically change the value to 0.)																														
		1	Error clear for axis 2	0																															
		2	Error clear for axis 3	0																															
		3	Error clear for axis 4	0																															
		4	Error clear for axis 5	0																															
		5	Error clear for axis 6	0																															
6	Error clear for (virtual) axis 7	0																																	
7	Error clear for (virtual) axis 8	0																																	
15-8	—	—	—																																
H112 - H128	Reserved for system	—																																	
H129	No. of error occurrences of axis 1	Notifies the number of occurrences of errors at axis 1.																																	
H12A H12B	Error code annunciation buffer 1 of axis 1	Stores the latest error codes in order from buffer 1.																																	
H12C H12D	Error code annunciation buffer 2 of axis 1																																		
H12E H12F	Error code annunciation buffer 3 of axis 1																																		
H130 H131	Error code annunciation buffer 4 of axis 1																																		
H132 H133	Error code annunciation buffer 5 of axis 1																																		
H134 H135	Error code annunciation buffer 6 of axis 1																																		
H136 H137	Error code annunciation buffer 7 of axis 1																																		
H138	Reserved for system	—																																	
H139	No. of error occurrences of axis 2	Notifies the number of occurrences of errors at axis 2.																																	
H13A H13B	Error code annunciation buffer 1 of axis 2	Stores the latest error codes in order from buffer 1.																																	
H13C H13D	Error code annunciation buffer 2 of axis 2																																		
H13E H13F	Error code annunciation buffer 3 of axis 2																																		
H140 H141	Error code annunciation buffer 4 of axis 2																																		
H142 H143	Error code annunciation buffer 5 of axis 2																																		
H144 H145	Error code annunciation buffer 6 of axis 2																																		
H146 H147	Error code annunciation buffer 7 of axis 2																																		

Specifications

Offset Address	Name	Description
H148	Reserved for system	—
H149	No. of error occurrences of axis 3	Notifies the number of occurrences of errors at axis 3.
H14A H14B	Error code annunciation buffer 1 of axis 3	Stores the latest error codes in order from buffer 1.
H14C H14D	Error code annunciation buffer 2 of axis 3	
H14E H14F	Error code annunciation buffer 3 of axis 3	
H150 H151	Error code annunciation buffer 4 of axis 3	
H152 H153	Error code annunciation buffer 5 of axis 3	
H154 H155	Error code annunciation buffer 6 of axis 3	
H156 H157	Error code annunciation buffer 7 of axis 3	
H158	Reserved for system	
H159	No. of error occurrences of axis 4	Notifies the number of occurrences of errors at axis 4.
H15A H15B	Error code annunciation buffer 1 of axis 4	Stores the latest error codes in order from buffer 1.
H15C H15D	Error code annunciation buffer 2 of axis 4	
H15E H15F	Error code annunciation buffer 3 of axis 4	
H160 H161	Error code annunciation buffer 4 of axis 4	
H162 H163	Error code annunciation buffer 5 of axis 4	
H164 H165	Error code annunciation buffer 6 of axis 4	
H166 H167	Error code annunciation buffer 7 of axis 4	
H168	Reserved for system	

Offset Address	Name	Description
H169	No. of error occurrences of axis 5	Notifies the number of occurrences of errors at axis 5.
H16A H16B	Error code annunciation buffer 1 of axis 5	Stores the latest error codes in order from buffer 1.
H16C H16D	Error code annunciation buffer 2 of axis 5	
H16E H16F	Error code annunciation buffer 3 of axis 5	
H170 H171	Error code annunciation buffer 4 of axis 5	
H172 H173	Error code annunciation buffer 5 of axis 5	
H174 H175	Error code annunciation buffer 6 of axis 5	
H176 H177	Error code annunciation buffer 7 of axis 5	
H178	Reserved for system	
H179	No. of error occurrences of axis 6	Notifies the number of occurrences of errors at axis 6.
H17A H17B	Error code annunciation buffer 1 of axis 6	Stores the latest error codes in order from buffer 1.
H17C H17D	Error code annunciation buffer 2 of axis 6	
H17E H17F	Error code annunciation buffer 3 of axis 6	
H180 H181	Error code annunciation buffer 4 of axis 6	
H182 H183	Error code annunciation buffer 5 of axis 6	
H184 H185	Error code annunciation buffer 6 of axis 6	
H186 H187	Error code annunciation buffer 7 of axis 6	
H188	Reserved for system	

Specifications

Offset Address	Name	Description
H189	No. of error occurrences of (virtual) axis 7	Notifies the number of occurrences of errors at axis 7.
H18A H18B	Error code annunciation buffer 1 of (virtual) axis 7	Stores the latest error code from the buffer number 1 in order.
H18C H18D	Error code annunciation buffer 2 of (virtual) axis 7	
H18E H18F	Error code annunciation buffer 3 of (virtual) axis 7	
H190 H191	Error code annunciation buffer 4 of (virtual) axis 7	
H192 H193	Error code annunciation buffer 5 of (virtual) axis 7	
H194 H195	Error code annunciation buffer 6 of (virtual) axis 7	
H196 H197	Error code annunciation buffer 7 of (virtual) axis 7	
H198	Reserved for system	
H199	No. of error occurrences of (virtual) axis 8	Notifies the number of occurrences of errors at axis 8.
H19A H19B	Error code annunciation buffer 1 of (virtual) axis 8	Stores the latest error code from the buffer number 1 in order.
H19C H19D	Error code annunciation buffer 2 of (virtual) axis 8	
H19E H19F	Error code annunciation buffer 3 of (virtual) axis 8	
H1A0 H1A1	Error code annunciation buffer 4 of (virtual) axis 8	
H1A2 H1A3	Error code annunciation buffer 5 of (virtual) axis 8	
H1A4 H1A5	Error code annunciation buffer 6 of (virtual) axis 8	
H1A6 H1A7	Error code annunciation buffer 7 of (virtual) axis 8	

■ Warning annunciation & clear area

Offset Address	Name	Description																																	
H1A8	Reserved for system	-																																	
H1A9	Warning clear individual axis setting	Executes the error clear for each axis.																																	
		<table border="1"> <thead> <tr> <th>bit</th> <th>Name</th> <th>Default</th> <th>Description</th> </tr> </thead> <tbody> <tr> <td>0</td> <td>Warning clear for axis 1</td> <td>0</td> <td rowspan="9">0: Not clear warnings 0 to 1: clear warnings (After execution, the control unit will automatically change the value to 0.)</td> </tr> <tr> <td>1</td> <td>Warning clear for axis 2</td> <td>0</td> </tr> <tr> <td>2</td> <td>Warning clear for axis 3</td> <td>0</td> </tr> <tr> <td>3</td> <td>Warning clear for axis 4</td> <td>0</td> </tr> <tr> <td>4</td> <td>Warning clear for axis 5</td> <td>0</td> </tr> <tr> <td>5</td> <td>Warning clear for axis 6</td> <td>0</td> </tr> <tr> <td>6</td> <td>Warning clear for (virtual) axis 7</td> <td>0</td> </tr> <tr> <td>7</td> <td>Warning clear for (virtual) axis 8</td> <td>0</td> </tr> <tr> <td>15-8</td> <td>—</td> <td>—</td> <td>—</td> </tr> </tbody> </table>	bit	Name	Default	Description	0	Warning clear for axis 1	0	0: Not clear warnings 0 to 1: clear warnings (After execution, the control unit will automatically change the value to 0.)	1	Warning clear for axis 2	0	2	Warning clear for axis 3	0	3	Warning clear for axis 4	0	4	Warning clear for axis 5	0	5	Warning clear for axis 6	0	6	Warning clear for (virtual) axis 7	0	7	Warning clear for (virtual) axis 8	0	15-8	—	—	—
		bit	Name	Default	Description																														
		0	Warning clear for axis 1	0	0: Not clear warnings 0 to 1: clear warnings (After execution, the control unit will automatically change the value to 0.)																														
		1	Warning clear for axis 2	0																															
		2	Warning clear for axis 3	0																															
		3	Warning clear for axis 4	0																															
		4	Warning clear for axis 5	0																															
		5	Warning clear for axis 6	0																															
6	Warning clear for (virtual) axis 7	0																																	
7	Warning clear for (virtual) axis 8	0																																	
15-8	—	—	—																																
H1AA - H1C0	Reserved for system	—																																	
H1C1	No. of warning occurrences of axis 1	Notifies the number of occurrences of warnings at axis 1.																																	
H1C2 H1C3	Warning code annunciation buffer 1 of axis 1	Saves the latest warning codes in order from buffer 1.																																	
H1C4 H1C5	Warning code annunciation buffer 2 of axis 1																																		
H1C6 H1C7	Warning code annunciation buffer 3 of axis 1																																		
H1C8 H1C9	Warning code annunciation buffer 4 of axis 1																																		
H1CA H1CB	Warning code annunciation buffer 5 of axis 1																																		
H1CC H1CD	Warning code annunciation buffer 6 of axis 1																																		
H1CE H1CF	Warning code annunciation buffer 7 of axis 1																																		
H1D0	Reserved for system		—																																
H1D1	No. of warning occurrences of axis 2	Notifies the number of occurrences of warnings at axis 2.																																	
H1D2 H1D3	Warning code annunciation buffer 1 of axis 2	Saves the latest warning codes in order from buffer 1.																																	
H1D4 H1D5	Warning code annunciation buffer 2 of axis 2																																		
H1D6 H1D7	Warning code annunciation buffer 3 of axis 2																																		
H1D8 H1D9	Warning code annunciation buffer 4 of axis 2																																		
H1DA H1DB	Warning code annunciation buffer 5 of axis 2																																		
H1DC H1DD	Warning code annunciation buffer 6 of axis 2																																		
H1DE H1DF	Warning code annunciation buffer 7 of axis 2																																		

Specifications

Offset Address	Name	Description
H1E0	Reserved for system	—
H1E1	No. of warning occurrences of axis 3	Notifies the number of occurrences of warnings at axis 3.
H1E2 H1E3	Warning code annunciation buffer 1 of axis 3	Saves the latest warning codes in order from buffer 1.
H1E4 H1E5	Warning code annunciation buffer 2 of axis 3	
H1E6 H1E7	Warning code annunciation buffer 3 of axis 3	
H1E8 H1E9	Warning code annunciation buffer 4 of axis 3	
H1EA H1EB	Warning code annunciation buffer 5 of axis 3	
H1EC H1ED	Warning code annunciation buffer 6 of axis 3	
H1EE H1EF	Warning code annunciation buffer 7 of axis 3	
H1F0	Reserved for system	—
H1F1	No. of warning occurrences of axis 4	Notifies the number of occurrences of warnings at axis 4.
H1F2 H1F3	Warning code annunciation buffer 1 of axis 4	Saves the latest warning codes in order from buffer 1.
H1F4 H1F5	Warning code annunciation buffer 2 of axis 4	
H1F6 H1F7	Warning code annunciation buffer 3 of axis 4	
H1F8 H1F9	Warning code annunciation buffer 4 of axis 4	
H1FA H1FB	Warning code annunciation buffer 5 of axis 4	
H1FC H1FD	Warning code annunciation buffer 6 of axis 4	
H1FE H1FF	Warning code annunciation buffer 7 of axis 4	
H200	Reserved for system	—

Offset Address	Name	Description
H201	No. of warning occurrences of axis 5	Notifies the number of occurrences of warnings at axis 5.
H202 H203	Warning code annunciation buffer 1 of axis 5	Saves the latest warning codes in order from buffer 1.
H204 H205	Warning code annunciation buffer 2 of axis 5	
H206 H207	Warning code annunciation buffer 3 of axis 5	
H208 H209	Warning code annunciation buffer 4 of axis 5	
H20A H20B	Warning code annunciation buffer 5 of axis 5	
H20C H20D	Warning code annunciation buffer 6 of axis 5	
H20E H20F	Warning code annunciation buffer 7 of axis 5	
H210	Reserved for system	
H211	No. of warning occurrences of axis 6	Notifies the number of occurrences of warnings at axis 6.
H212 H213	Warning code annunciation buffer 1 of axis 6	Saves the latest warning codes in order from buffer 1.
H214 H215	Warning code annunciation buffer 2 of axis 6	
H216 H217	Warning code annunciation buffer 3 of axis 6	
H218 H219	Warning code annunciation buffer 4 of axis 6	
H21A H21B	Warning code annunciation buffer 5 of axis 6	
H21C H21D	Warning code annunciation buffer 6 of axis 6	
H21E H21F	Warning code annunciation buffer 7 of axis 6	
H220	Reserved for system	

Specifications

Offset Address	Name	Description
H221	No. of warning occurrences of (virtual) axis 7	Notifies the number of occurrences of warnings at axis 7.
H222 H223	Warning code annunciation buffer 1 of (virtual) axis 7	Stores the latest warning code from the buffer number 1 in order.
H224 H225	Warning code annunciation buffer 2 of (virtual) axis 7	
H226 H227	Warning code annunciation buffer 3 of (virtual) axis 7	
H228 H229	Warning code annunciation buffer 4 of (virtual) axis 7	
H22A H22B	Warning code annunciation buffer 5 of (virtual) axis 7	
H22C H22D	Warning code annunciation buffer 6 of (virtual) axis 7	
H22E H22F	Warning code annunciation buffer 7 of (virtual) axis 7	
H230	Reserved for system	
H231	No. of warning occurrences of (virtual) axis 8	Notifies the number of occurrences of warnings at axis 8.
H232 H233	Warning code annunciation buffer 1 of (virtual) axis 8	Stores the latest warning code from the buffer number 1 in order.
H234 H235	Warning code annunciation buffer 2 of (virtual) axis 8	
H236 H237	Warning code annunciation buffer 3 of (virtual) axis 8	
H238 H239	Warning code annunciation buffer 4 of (virtual) axis 8	
H23A H23B	Warning code annunciation buffer 5 of (virtual) axis 8	
H23C H23D	Warning code annunciation buffer 6 of (virtual) axis 8	
H23E H23F	Warning code annunciation buffer 7 of (virtual) axis 8	

■ Synchronous control monitor area

Offset address	Name	Default	Description																																															
H240 -H2AF	Reserved for system	—	—																																															
H2B0	Synchronous master axis information monitor of axis 1	HF	<p>Stores the setting status of the master axis under synchronous control.</p> <table border="1"> <thead> <tr> <th colspan="2">Stored value</th> <th rowspan="2">Master axis</th> </tr> <tr> <th>Synchronizing</th> <th>Canceling synchronization</th> </tr> </thead> <tbody> <tr> <td>FFFFH</td> <td>FFFFH</td> <td>No synchronous setting</td> </tr> <tr> <td>0000H</td> <td>8000H</td> <td>The target axis for monitoring is the master axis.</td> </tr> <tr> <td>0001H</td> <td>8001H</td> <td>Axis 1</td> </tr> <tr> <td>0002H</td> <td>8002H</td> <td>Axis 2</td> </tr> <tr> <td>0003H</td> <td>8003H</td> <td>Axis 3</td> </tr> <tr> <td>0004H</td> <td>8004H</td> <td>Axis 4</td> </tr> <tr> <td>0005H</td> <td>8005H</td> <td>Axis 5</td> </tr> <tr> <td>0006H</td> <td>8006H</td> <td>Axis 6</td> </tr> <tr> <td>0007H</td> <td>8007H</td> <td>Axis 7 (virtual)</td> </tr> <tr> <td>0008H</td> <td>8008H</td> <td>Axis 8 (virtual)</td> </tr> <tr> <td>0021H</td> <td>8021H</td> <td>Pulse input 1</td> </tr> <tr> <td>0022H</td> <td>8022H</td> <td>Pulse input 2</td> </tr> <tr> <td>0023H</td> <td>8023H</td> <td>Pulse input 3</td> </tr> <tr> <td>0024H</td> <td>8024H</td> <td>Pulse input 4</td> </tr> </tbody> </table>	Stored value		Master axis	Synchronizing	Canceling synchronization	FFFFH	FFFFH	No synchronous setting	0000H	8000H	The target axis for monitoring is the master axis.	0001H	8001H	Axis 1	0002H	8002H	Axis 2	0003H	8003H	Axis 3	0004H	8004H	Axis 4	0005H	8005H	Axis 5	0006H	8006H	Axis 6	0007H	8007H	Axis 7 (virtual)	0008H	8008H	Axis 8 (virtual)	0021H	8021H	Pulse input 1	0022H	8022H	Pulse input 2	0023H	8023H	Pulse input 3	0024H	8024H	Pulse input 4
Stored value		Master axis																																																
Synchronizing	Canceling synchronization																																																	
FFFFH	FFFFH	No synchronous setting																																																
0000H	8000H	The target axis for monitoring is the master axis.																																																
0001H	8001H	Axis 1																																																
0002H	8002H	Axis 2																																																
0003H	8003H	Axis 3																																																
0004H	8004H	Axis 4																																																
0005H	8005H	Axis 5																																																
0006H	8006H	Axis 6																																																
0007H	8007H	Axis 7 (virtual)																																																
0008H	8008H	Axis 8 (virtual)																																																
0021H	8021H	Pulse input 1																																																
0022H	8022H	Pulse input 2																																																
0023H	8023H	Pulse input 3																																																
0024H	8024H	Pulse input 4																																																
H2B1	Synchronous output function selection status monitor of axis 1	H0	<p>Stores the status of the synchronous operation function set for the axes.</p> <table border="1"> <thead> <tr> <th>bit</th> <th>Function</th> <th>Setting</th> </tr> </thead> <tbody> <tr> <td>0</td> <td>Electronic gear operation settings</td> <td rowspan="2">0: Use 1: Not use</td> </tr> <tr> <td>1</td> <td>Clutch operation setting</td> </tr> <tr> <td>2</td> <td>Electronic operation setting</td> <td rowspan="2">—</td> </tr> <tr> <td>3</td> <td>Advance angle correction synchronous setting</td> </tr> <tr> <td>15-4</td> <td>—</td> <td>—</td> </tr> </tbody> </table>	bit	Function	Setting	0	Electronic gear operation settings	0: Use 1: Not use	1	Clutch operation setting	2	Electronic operation setting	—	3	Advance angle correction synchronous setting	15-4	—	—																															
bit	Function	Setting																																																
0	Electronic gear operation settings	0: Use 1: Not use																																																
1	Clutch operation setting																																																	
2	Electronic operation setting	—																																																
3	Advance angle correction synchronous setting																																																	
15-4	—	—																																																
H2B2	Synchronous master axis information monitor of axis 2	HF	Refer to the description for the axis 1																																															
H2B3	Synchronous output function selection status monitor of axis 2	H0	Refer to the description for the axis 1																																															
H2B4	Synchronous master axis information monitor of axis 3	HF	Refer to the description for the axis 1																																															
H2B5	Synchronous output function selection status monitor of axis 3	H0	Refer to the description for the axis 1																																															
H2B6	Synchronous master axis information monitor of axis 4	HF	Refer to the description for the axis 1																																															
H2B7	Synchronous output function selection status monitor of axis 4	H0	Refer to the description for the axis 1																																															
H2B8	Synchronous master axis information monitor of axis 5	HF	Refer to the description for the axis 1																																															
H2B9	Synchronous output function selection status monitor of axis 5	H0	Refer to the description for the axis 1																																															

Offset address	Name	Default	Description
H2BA	Synchronous master axis information monitor of axis 6	HF	Refer to the description for the axis 1
H2BB	Synchronous output function selection status monitor of axis 6	H0	Refer to the description for the axis 1
H2BC	Synchronous master axis information monitor of (virtual) axis 7	HF	Refer to the description for the axis 1
H2BD	Synchronous output function selection status monitor of (virtual) axis 7	H0	Refer to the description for the axis 1
H2BE	Synchronous master axis information monitor of (virtual) axis 8	HF	Refer to the description for the axis 1
H2BF	Synchronous output function selection status monitor of (virtual) axis 8	H0	Refer to the description for the axis 1

■ System operation setting area

Offset address	Name	Default	Description
H2C0 -H388	Reserved for system	—	—
H389	Deceleration stop operation	K0	<p>Specify the operation when setting the deceleration stop request signal to "Active" (from OFF to ON).</p> <p>0: Deceleration stop When performing the repeat operation, stops after reaching E point that is targeted for the repeat operation.</p> <p>1: Pause <ul style="list-style-type: none"> Performs the deceleration stop, and restarts the positioning operation when turning "Deceleration stop request signal" to OFF from ON. Also, performs the same operation as the deceleration stop in all states except during the positioning operation. When performing the repeat operation, stops after reaching E point that is targeted for the repeat operation, and restarts the positioning operation when turning "Deceleration stop request signal" to OFF from ON. If a system stop or emergency stop is executed while the positioning unit is paused, the pause state will be canceled and the operation will not restart with the deceleration stop request signal is canceled (turned OFF). </p>
H38A -H38F	Reserved for system	—	—

■ AMP monitor & control area

Offset address	Name	Default	Description
H390	AMP ID number	K1	Specify the target axis number (AMP ID no.) to monitor AMP parameters. Setting range: K1-K8
H391	Control flag	H0	Specify the type code of the item to be monitored. (Note) The FP-XH M8N control unit executes the monitoring processing requested by the flag after detecting the change of this flag from H0 to Hxx. The unit changes the flag to H0 (no request) simultaneously with the completion of the processing.
H392	Status	H0	Stores the processing state of the AMP monitor. The FP-XH M8N control unit changes this area to H1 simultaneously with the start of the processing. After that, it stores the processing result and change the control flag to H0. H0: No operation H1: Being processed H2: Normal end H3: Abnormal end H4: ID error (AMP ID no. unconnected) H5: Disabled (Network is disconnected, etc.)
H393	Reserved for system	—	—
H394	Monitor data	—	Stores the monitoring result of the requested monitoring item.
H395			
H396~ H39F	Reserved for system	—	—

(Note): For the type codes, refer to "17.14 AMP Monitoring Function".

■ Pulse input setting area

Offset address	Name	Default	Setting range and description		
H3A0	Pulse input mode of CH1	H20	Set the pulse input function.		
			bit	Name	Description
			0	Rotation direction	Set the rotation direction of pulse input. 0: Forward 1: Reverse
			1	—	—
			3-2	Pulse input mode	Set the input method of pulse input. Bit3 Bit2 0 0: 2-phase input 0 1: Direction distinction input 1 0: Individual input 1 1: Reserved for system (When set, it will be 2-phase input.)
			5-4	Input transfer multiple	Set the multiple when setting the pulse input mode (Bit2-3) to "2-phase input". Bit5 Bit4 0 0: x1 (1 multiple) 0 1: x2 (2 multiple) 1 0: x4 (4 multiple) 1 1: Reserved for system (When set, it will be 4 multiple.)
			7-6	Pulse input purpose	Specify the purpose of pulse input for each axis. ·Pulsar: Connect a manual pulsar to the pulse input. ·High-speed counter Bit7 Bit6 0 0: Pulsar 0 1: Reserved for system (When set, it will be pulsar.) 1 0: High-speed counter 1 1: Reserved for system (When set, it will be pulsar.)
10-8	Pulse input time constant	Set the time constant of each pulse input signal. The pulse inputs A and B of the same axis are the same input time constant. Bit10 Bit9 Bit8 0 0 0 : No input time constant 0 0 1: 0.1 μs 0 0 1: 0.5 μs 0 1 1: 1.0 μs 1 0 0: 2.0 μs 1 0 1: 10.0 μs 1 1 0: No input time constant 1 1 1: No input time constant			
15-11	—	—			
H3A1	Pulse input mode of CH2	H20	Refer to the description for the axis 1		
H3A2	Pulse input mode of CH3	H20			
H3A3	Pulse input mode of CH4	H20			

■ Pulse count control area

Offset address	Name	Default	Description			
H3A8	Pulse count enable flag	H0	When the corresponding bit to each axis turns to 0, the count of pulse input will start. This flag is available only when setting the pulse input purpose to "High-speed counter".			
			bit	Name	Default	Description
			0	Enable pulse count of CH1	0	0: Count pulse input 1: Not count pulse input
			1	Enable pulse count of CH2	0	
			2	Enable pulse count of CH3	0	
3	Enable pulse output of CH4	0				
15-4	—	—	—			
H3A9	Pulse count value change request flag	H0	When the corresponding bit to each axis changes to 1 from 0, the pulse input will be changed to the pulse count change value that the pulse input count value has been set. This flag is an edge trigger. Always change this flag to 1 from 0 before change.			
			bit	Name	Default	Description
			0	Change pulse count of CH1	0	0: Not change pulse count values. 0→1: Change pulse count values.
			1	Change pulse count of CH2	0	
			2	Change pulse count of CH3	0	
3	Change pulse count of CH4	0				
15-4	—	—	—			
H3AA ~H3AF	Reserved for system		—			
H3B0 H3B1	Pulse input change value of CH1	K0	Set the pulse input values to be changed for each axis. Range: - 2,147,483,628 to 2,147,483,627			
H3B2 H3B3	Pulse input change value of CH2	K0				
H3B4 H3B5	Pulse input change value of CH3	K0				
H3B6 H3B7	Pulse input change value of CH4	K0				

■ Pulse input monitor area

Offset address	Name	Description
H3C0 H3C1	Pulse input value of CH1	Stores the pulse input values (pulsar, counter) according to the pulse input purposes. The pulse input value is stored by integrating the pulse input values until changing the pulse input purpose or clearing the pulse input. Unit: Pulse
H3C2 H3C3	Pulse input value of CH2	
H3C4 H3C5	Pulse input value of CH3	
H3C6 H3C7	Pulse input value of CH4	

26.4.3 Each Axis Information Area (Memory Area No. 1)

Offset address	Name	Description																																								
H0-H7	System ID (Brand name or vendor name)	Stores the brand name or vendor name. It is stored as the ASCII code up to 16 bytes (max. 16 characters).																																								
H8-HF	System ID (Model code of AMP)	Stores the model code of AMP. It is stored as the ASCII code up to 16 bytes (max. 16 characters).																																								
H10-H17	System ID (Version of firmware)	Stores the firmware version of AMP. It is stored as the ASCII code up to 16 bytes (max. 16 characters).																																								
H18-H1F	System ID (Model code of motor)	Stores the model code of motor. It is stored as the ASCII code up to 16 bytes (max. 16 characters).																																								
H20-H21	Phase of slave axis	Stores the phase of slave axis after clutch control. In this area, the target axis is set for the slave axis, and it is stored when using the electronic cam function. - The unit system of the master axis is used. For using phase information in percent, perform the following calculation. $\text{Phase (\%)} = \text{Phase after clutch control} / \text{Master cycle of synchronous operation} \times 100$ - The phase of slave axis will be cleared at the following timing; - when the unit is activated. - when the slave axis setting is canceled. - when it is not in the synchronous state.																																								
H22-H23	Reserved for system	—																																								
H24-H25	Advance angle correction amount	Stores the advance angle correction amount. Stores values converted with the unit system (pulse, μm , inch, degree) selected for the master axis.																																								
H26-H2F	Reserved for system	—																																								
H30	Status display	Stores the status of AMP. <table border="1"> <thead> <tr> <th>bit</th> <th>Name</th> <th>Default</th> <th>Description</th> </tr> </thead> <tbody> <tr> <td>0</td> <td>Imposition</td> <td>0</td> <td>0: Deviation counter is outside of the imposition range. 1: Deviation counter is in the imposition range.</td> </tr> <tr> <td>1</td> <td>—</td> <td>—</td> <td>—</td> </tr> <tr> <td>2</td> <td>Home return done</td> <td>0</td> <td>0: Home return has not completed. 1: Home return has completed.</td> </tr> <tr> <td>3</td> <td>Torque limit</td> <td>0</td> <td>0: Normal 1: Contact detection (Torque limit)</td> </tr> <tr> <td>4</td> <td>Warning</td> <td>0</td> <td>0: Normal 1: Warning occurred</td> </tr> <tr> <td>5</td> <td>Alarm</td> <td>0</td> <td>0: Normal 1: Alarm occurred</td> </tr> <tr> <td>6</td> <td>Servo ready</td> <td>0</td> <td>0: State that cannot shift to the servo-on state. 1: Servo ready</td> </tr> <tr> <td>7</td> <td>Servo active</td> <td>0</td> <td>0: Servo off 1: Servo on</td> </tr> <tr> <td>15-8</td> <td>—</td> <td>—</td> <td>—</td> </tr> </tbody> </table>	bit	Name	Default	Description	0	Imposition	0	0: Deviation counter is outside of the imposition range. 1: Deviation counter is in the imposition range.	1	—	—	—	2	Home return done	0	0: Home return has not completed. 1: Home return has completed.	3	Torque limit	0	0: Normal 1: Contact detection (Torque limit)	4	Warning	0	0: Normal 1: Warning occurred	5	Alarm	0	0: Normal 1: Alarm occurred	6	Servo ready	0	0: State that cannot shift to the servo-on state. 1: Servo ready	7	Servo active	0	0: Servo off 1: Servo on	15-8	—	—	—
bit	Name	Default	Description																																							
0	Imposition	0	0: Deviation counter is outside of the imposition range. 1: Deviation counter is in the imposition range.																																							
1	—	—	—																																							
2	Home return done	0	0: Home return has not completed. 1: Home return has completed.																																							
3	Torque limit	0	0: Normal 1: Contact detection (Torque limit)																																							
4	Warning	0	0: Normal 1: Warning occurred																																							
5	Alarm	0	0: Normal 1: Alarm occurred																																							
6	Servo ready	0	0: State that cannot shift to the servo-on state. 1: Servo ready																																							
7	Servo active	0	0: Servo off 1: Servo on																																							
15-8	—	—	—																																							

Offset address	Name	Description																																	
H31	External terminal input monitor	Stores the information of I/O connected to AMP.																																	
		<table border="1"> <thead> <tr> <th>bit</th> <th>Name</th> <th>Default</th> <th>Description</th> </tr> </thead> <tbody> <tr> <td>0</td> <td>CWL</td> <td>0</td> <td rowspan="9">0: Non active 1: Active</td> </tr> <tr> <td>1</td> <td>CCWL</td> <td>0</td> </tr> <tr> <td>2</td> <td>HOME (Proximity)</td> <td>0</td> </tr> <tr> <td>3</td> <td>EX-IN1</td> <td>0</td> </tr> <tr> <td>4</td> <td>EX-IN2</td> <td>0</td> </tr> <tr> <td>5</td> <td>EX-IN3</td> <td>0</td> </tr> <tr> <td>6</td> <td>EX-SON/EX-IN4</td> <td>0</td> </tr> <tr> <td>7</td> <td>EMG-STP</td> <td>0</td> </tr> <tr> <td>15-8</td> <td>—</td> <td>—</td> <td>—</td> </tr> </tbody> </table>	bit	Name	Default	Description	0	CWL	0	0: Non active 1: Active	1	CCWL	0	2	HOME (Proximity)	0	3	EX-IN1	0	4	EX-IN2	0	5	EX-IN3	0	6	EX-SON/EX-IN4	0	7	EMG-STP	0	15-8	—	—	—
		bit	Name	Default	Description																														
		0	CWL	0	0: Non active 1: Active																														
		1	CCWL	0																															
		2	HOME (Proximity)	0																															
		3	EX-IN1	0																															
		4	EX-IN2	0																															
		5	EX-IN3	0																															
6	EX-SON/EX-IN4	0																																	
7	EMG-STP	0																																	
15-8	—	—	—																																
H32	Torque monitor	Stores the torque monitor values. Range: 0-5000 Unit: 0.1 %																																	
H33	Speed monitor	Stores the actual speed monitor values. Unit: rpm																																	
H34-H35	Position deviation	Stores the deviation between the current position managed in the control unit and the AMP current position fed back from the AMP.																																	
H38	Active or execution done table	Stores the number of active positioning table or when the operation completed.																																	
H39	Auxiliary output code	Stores the auxiliary output code.																																	
H3A	Repeat count set value	Stores the setting value of positioning repeat count. Stores 1 when no repeat operation is performed. Stores 255 when the repeat count is unlimited. Unit: Times																																	
H3B	Repeat count current value	Stores the repeat count during the operation. Stores 1 when no repeat operation is performed. Returns to "0" when the repeat count exceeds the upper limit. Unit: Times																																	
H3C-H3D	Current value	Stores the current value based on a mechanical origin in pulse units. It will be reset to "0" on the completion of home return. The value will not be updated when the current value update function is executed. Unit: pulse																																	
H3E-H3F	Unit system conversion current value	Stores the current value based on a electric origin (value set as home position coordinate). Values converted with the unit system (pulse, μm , inch, degree) selected in each axis setting area are stored. When the home return is completed, the value set as home position coordinate will be stored. When "0" is set as home position coordinate, it will be reset to "0". This area is also updated when the current value update function is used.																																	

26.4.4 Each Axis Setting Area (Memory Area No. 2)

■ Positioning parameters of each axis

Data in the following formats are stored from the starting address of positioning parameters of each axis.

Offset address	Name	Default	Setting range and description
H0	Unit setting	H0	<p>Sets the unit system of movement amounts of the positioning control for each axis. The same unit system should be set for all interpolation axes.</p> <p>H0: Pulse H100: μm (Min. position command 0.1 μm) H101: μm (Min. position command 1 μm) H200: inch (Min. position command 0.1 inch) H201: inch (Min. position command 1 inch) H300: degree (Min. position command 0.1 degree) H301: degree (Min. position command 1 degree)</p> <p>Any other settings will be errors.</p>
H1	Reserved for system	—	—
H2-H3	Pulse number per rotation	K1	<p>Sets the pulse number per rotation. It is necessary for the conversion of the pulse number in the settings of mm, inch and degree.</p> <p>Range: K1-K16,777,215</p> <p>Any other settings will be errors.</p>
H4-H5	Movement amount per rotation	K1	<p>Set the movement amount per rotation. It is necessary for the conversion of the pulse number in the settings of mm, inch and degree.</p> <p>Range: K1-K16,777,215</p> <p>Any other settings will be errors.</p> <p>The ranges vary depending on the unit settings as below.</p> <p>μm: 1 μm inch: 1/10,000 inch degree: 1 degree</p>
H6	Reserved for system	—	—

Offset address	Name	Default	Setting range and description																				
HB	Software limit enabled/disabled setting	H0	Enables or disables the software limit on each control.																				
			<table border="1"> <thead> <tr> <th>bit</th> <th>Name</th> <th>Default</th> <th>Description</th> </tr> </thead> <tbody> <tr> <td>0</td> <td>Enable/disable the software limit in the positioning control.</td> <td>0</td> <td>0: Disables the software limit in positioning control 1: Enables the software limit in positioning control</td> </tr> <tr> <td>1</td> <td>Enable/disable the software limit in the home return</td> <td>0</td> <td>0: Disables the software limit in home return. 1: Enables the software limit in home return.</td> </tr> <tr> <td>2</td> <td>Enable/disable the software limit in JOG operation</td> <td>0</td> <td>0: Disables the software limit in JOG operation. 1: Enables the software limit in JOG operation.</td> </tr> <tr> <td>15-3</td> <td>—</td> <td>—</td> <td>—</td> </tr> </tbody> </table>	bit	Name	Default	Description	0	Enable/disable the software limit in the positioning control.	0	0: Disables the software limit in positioning control 1: Enables the software limit in positioning control	1	Enable/disable the software limit in the home return	0	0: Disables the software limit in home return. 1: Enables the software limit in home return.	2	Enable/disable the software limit in JOG operation	0	0: Disables the software limit in JOG operation. 1: Enables the software limit in JOG operation.	15-3	—	—	—
			bit	Name	Default	Description																	
			0	Enable/disable the software limit in the positioning control.	0	0: Disables the software limit in positioning control 1: Enables the software limit in positioning control																	
			1	Enable/disable the software limit in the home return	0	0: Disables the software limit in home return. 1: Enables the software limit in home return.																	
2	Enable/disable the software limit in JOG operation	0	0: Disables the software limit in JOG operation. 1: Enables the software limit in JOG operation.																				
15-3	—	—	—																				
HC-HD	Upper limit of software limit	K2147482624	<p>Set the upper limit of the software limit for absolute coordinates. Range: - 2,147,482,624 to 2,147,482,624</p> <p>Any other settings will be errors.The ranges vary depending on the unit settings as below.</p> <p>pulse: - 2,147,482,624 to 2,147,482,624 pulse μm (0.1 μm): - 214,748,262.4 to 214,748,262.4 μm μm (1 μm): - 2,147,482,624 to 2,147,482,624 μm inch (0.00001 inch): - 21,474.82624 to 21,474.82624 inch inch (0.0001 inch): - 214,748.2624 to 214,748.2624 inch degree (0.1 degree): - 214,748,262.4 to 214,748,262.4 degree degree (1 degree): - 2,147,482,624 to 2,147,482,624 degree</p>																				
HE-HF	Lower limit of software limit	K-2147482624	<p>Set the lower limit of the software limit for absolute coordinates. Range: - 2,147,482,624 to 2,147,482,624</p> <p>Any other settings will be errors.The ranges vary depending on the unit settings as below.</p> <p>pulse: - 2,147,482,624 to 2,147,482,624 pulse μm (0.1 μm): - 214,748,262.4 to 214,748,262.4 μm μm (1 μm): - 2,147,482,624 to 2,147,482,624 μm inch (0.00001 inch): - 21,474.82624 to 21,474.82624 inch inch (0.0001 inch): - 214,748.2624 to 214,748.2624 inch degree (0.1 degree): - 214,748,262.4 to 214,748,262.4 degree degree (1 degree): - 2,147,482,624 to 2,147,482,624 degree</p>																				

Offset Address	Name	Default	Setting range and description																				
H10-H11	System reserved	—	—																				
H12	Auxiliary output mode	HA00	Sets to enable/disable auxiliary output contacts and auxiliary output codes. The ON time of auxiliary output contacts is determined by the following auxiliary output ON time.																				
			<table border="1"> <thead> <tr> <th>bit</th> <th>Name</th> <th>Default</th> <th>Description</th> </tr> </thead> <tbody> <tr> <td>7-0</td> <td>Auxiliary output mode</td> <td>H0</td> <td>0000H: Disable auxiliary output function (auxiliary output contacts and auxiliary output codes). 0001H: Use With mode 0002H: Use Delay mode</td> </tr> <tr> <td>15-8</td> <td>Auxiliary output ON time</td> <td>HA</td> <td>Setting range: 00H (0 ms) - FFH (255 ms)</td> </tr> </tbody> </table>	bit	Name	Default	Description	7-0	Auxiliary output mode	H0	0000H: Disable auxiliary output function (auxiliary output contacts and auxiliary output codes). 0001H: Use With mode 0002H: Use Delay mode	15-8	Auxiliary output ON time	HA	Setting range: 00H (0 ms) - FFH (255 ms)								
			bit	Name	Default	Description																	
7-0	Auxiliary output mode	H0	0000H: Disable auxiliary output function (auxiliary output contacts and auxiliary output codes). 0001H: Use With mode 0002H: Use Delay mode																				
15-8	Auxiliary output ON time	HA	Setting range: 00H (0 ms) - FFH (255 ms)																				
H13	Auxiliary output Delay ratio	K0	Sets the ratio of output in the Delay mode during auxiliary output. The setting range is 0 (%) -100 (%), if set to 50%, the auxiliary output will be executed when the position control movement exceeds 50%.																				
H14	AMP operation setting	H1	Sets to enable/disable the limit input of AMP, or sets the movement direction and limit connection method, etc.																				
			Note) This setting should be written to the EEPROM within the AMP, and the AMP should be restarted after changing the setting.																				
			<table border="1"> <thead> <tr> <th>bit</th> <th>Name</th> <th>Default</th> <th>Description</th> </tr> </thead> <tbody> <tr> <td>0</td> <td>Limit enabled/disabled</td> <td>0</td> <td>0: Uses the input of limit signal. 1: Ignores the input of limit signal.</td> </tr> <tr> <td>1</td> <td>CW/CCW moving direction</td> <td>0</td> <td>0: CW+/CCW- 1: CCW+/CW-</td> </tr> <tr> <td>2</td> <td>Limit connection</td> <td>0</td> <td>0: Standard connection (Forward: CWL, Reverse: CCWL) 1: Reverse connection (Forward: CWL, Reverse: CCWL)</td> </tr> <tr> <td>15~3</td> <td>—</td> <td>—</td> <td>—</td> </tr> </tbody> </table>	bit	Name	Default	Description	0	Limit enabled/disabled	0	0: Uses the input of limit signal. 1: Ignores the input of limit signal.	1	CW/CCW moving direction	0	0: CW+/CCW- 1: CCW+/CW-	2	Limit connection	0	0: Standard connection (Forward: CWL, Reverse: CCWL) 1: Reverse connection (Forward: CWL, Reverse: CCWL)	15~3	—	—	—
			bit	Name	Default	Description																	
			0	Limit enabled/disabled	0	0: Uses the input of limit signal. 1: Ignores the input of limit signal.																	
1	CW/CCW moving direction	0	0: CW+/CCW- 1: CCW+/CW-																				
2	Limit connection	0	0: Standard connection (Forward: CWL, Reverse: CCWL) 1: Reverse connection (Forward: CWL, Reverse: CCWL)																				
15~3	—	—	—																				

Offset Address	Name	Default	Setting range and description																								
H1A -H1B	Completion width	K10	Turns on the completion flag when the current value of the AMP becomes within this completion width after the movement of a specified amount during the positioning control, JOG operation. Setting range: 0 to 2,147,482,624 (Pulse)																								
H1C	Monitor value error setting	—	The judgement values for torque monitor values and execution speed of each axis can be set to announce errors or warnings.																								
			<table border="1"> <thead> <tr> <th>bit</th> <th>Name</th> <th>Default</th> <th>Description</th> </tr> </thead> <tbody> <tr> <td>0</td> <td>Torque judgment value enabled</td> <td>0</td> <td>0: Disables the torque judgment value. 1: Enables the torque judgment value.</td> </tr> <tr> <td>1</td> <td>Torque judgment value error/warning setting</td> <td>0</td> <td>0: Announces an error when it is enabled. 1: Announces a warning when it is enabled.</td> </tr> <tr> <td>2</td> <td>Actual speed judgment value enabled</td> <td>0</td> <td>0: Disables the actual speed judgment value. 1: Enables the actual speed judgment value.</td> </tr> <tr> <td>3</td> <td>Actual speed judgment value error/warning setting</td> <td>0</td> <td>0: Announces an error when it is enabled. 1: Announces a warning when it is enabled.</td> </tr> <tr> <td>15-4</td> <td>—</td> <td>—</td> <td>—</td> </tr> </tbody> </table>	bit	Name	Default	Description	0	Torque judgment value enabled	0	0: Disables the torque judgment value. 1: Enables the torque judgment value.	1	Torque judgment value error/warning setting	0	0: Announces an error when it is enabled. 1: Announces a warning when it is enabled.	2	Actual speed judgment value enabled	0	0: Disables the actual speed judgment value. 1: Enables the actual speed judgment value.	3	Actual speed judgment value error/warning setting	0	0: Announces an error when it is enabled. 1: Announces a warning when it is enabled.	15-4	—	—	—
			bit	Name	Default	Description																					
			0	Torque judgment value enabled	0	0: Disables the torque judgment value. 1: Enables the torque judgment value.																					
			1	Torque judgment value error/warning setting	0	0: Announces an error when it is enabled. 1: Announces a warning when it is enabled.																					
			2	Actual speed judgment value enabled	0	0: Disables the actual speed judgment value. 1: Enables the actual speed judgment value.																					
3	Actual speed judgment value error/warning setting	0	0: Announces an error when it is enabled. 1: Announces a warning when it is enabled.																								
15-4	—	—	—																								
H1D	Torque judgement value	K5000	Set the limit of the torque. Setting range: 0-5000 (0.1%)																								
H1E H1F	Actual speed judgement value	K5000	Set the limit of the actual speed. Setting range: 0-5000 (rpm)																								

Specifications

Offset Address	Name	Default	Setting range and description
H20	Home return setting code	K0	<p>Set the pattern of home return.</p> <p>0: DOG method 1 1: DOG method 2 2: DOG method 3 3: Limit method 1 4: Limit method 2 5: Z-phase method 6: Stop-on-contact method 1 7: Stop-on-contact method 2 8: Data set</p> <p>Any other settings will be errors.</p>
H21	Home return direction	K0	<p>Set the operation direction of home return.</p> <p>0: Elapsed value decreasing direction (Limit - direction) 1: Elapsed value increasing direction (Limit "+" direction)</p> <p>Any other settings will be errors.</p>
H22	Home return acceleration time	K100	<p>Set the acceleration/deceleration time when performing the home return. At the beginning of the home return, accelerates for the specified acceleration time, decelerates for the specified deceleration time after the proximity input and changes to the creep speed.</p> <p>Setting range: 0-10,000 (ms)</p> <p>Any other settings will be errors.</p>
H23	Home return deceleration time		
H24-H25	Home return target speed	K1000	<p>Set the target speed when performing the home return. When there is no proximity input after starting the home return, accelerates to the target speed.</p> <p>Range: 1-2,147,482,624</p> <p>Any other settings will be errors. The ranges vary depending on the unit settings as below.</p> <p>pulse: 1-2,147,482,624 pps μm: 1-2,147,482,624 $\mu\text{m/s}$ inch: 0.001-2,147,482.624 inch/s degree: 0.001-2,147,482.624 rev/s</p>
H26-H27	Home return creep speed	K100	<p>Set the speed to search the home position after the proximity input. Set the value lower than the home return target speed.</p> <p>Range: 1-2,147,482,624</p> <p>Any other settings will be errors. The ranges vary depending on the unit settings as below.</p> <p>Pulse: 1-2,147,482,624 pps μm: 1-2,147,482,624 $\mu\text{m/s}$ inch: 0.001-2,147,482.624 inch/s degree: 0.001-2,147,482.624 rev/s</p>

Offset Address	Name	Default	Setting range and description			
H29	JOG operation setting code	H0	Sets the mode of the JOG operation.			
			bit	Name	Default	Description
			0	—	—	—
			1	Acceleration/deceleration pattern setting	0	0: Linear acceleration/deceleration 1: S-shaped acceleration/deceleration
15-2	—	—	—			
H2A	JOG operation acceleration time	K100	Sets the acceleration/deceleration time when performing the JOG operation. At the beginning of the JOG operation, accelerates for the specified acceleration time, decelerates for specified deceleration time when the starting contact of the JOG operation turns off, and stops. Setting range: 0-10,000 (ms) Any other settings will be errors.			
H2B	JOG operation deceleration time					
H2C-H2D	JOG operation target speed	K1000	Set the target speed for performing the JOG operation. After starting the JOG operation, accelerates to the target speed while the starting contact of the JOG operation is on. After reaching the target speed, operates at the target speed. Range: 1-2,147,482,624 Any other settings will be errors. The ranges vary depending on the unit settings as below. pulse: 1-2,147,482,624 pps µm: 1-2,147,482,624 µm/s inch: 0.001-2,147,482.624 inch/s degree: 0.001-2,147,482.624 rev/s			

Specifications

Offset Address	Name	Default	Setting range and description
H2E-H32	Reserved for system	—	—
H33	Emergency stop deceleration time	K100	When the emergency stop is requested by I/O, it will be valid, and the deceleration operation will complete in this deceleration time. Setting range: 0-10,000 (ms) Any other settings will be errors.
H34	Reserved for system	—	—
H35	Limit stop deceleration time	K100	When the limit is input, the deceleration operation will complete in this deceleration time. Setting range: 0-10,000 (ms) Any other settings will be errors.
H36	Reserved for system	—	—
H37	Error stop deceleration time	K100	When an error occurs, it will be valid, and the deceleration operation will complete in this deceleration time. Setting range: 0-10,000 (ms) Any other settings will be errors.
H38	Pulsar operation setting code	K0	Select the channels of the pulse input circuit that will be the input for the pulsar operation. 0: Pulse input CH1 1: Pulse input CH2 2: Pulse input CH3 3: Pulse input CH4 Any other settings will be errors.
H39	Pulsar operation ratio numerator	K1	Sets the multiplier for the input pulse string in the pulsar operation. (Number of command pulses) = (Pulse strings of input from pulsar) x (Numerator of ratio of pulsar operation) / (Denominator of ratio of pulsar operation). Setting range: K1-K32767 Any other settings will be errors.
H3A	Pulsar operation ratio denominator	K1	Sets the divisor for the input pulse string in the pulsar operation. (Number of command pulses) = (Pulse strings of input from pulsar) x (Numerator of ratio of pulsar operation) / (Denominator of ratio of pulsar operation). Setting range: K1-K32767 Any other settings will be errors.

Offset Address	Name	Default	Setting range and description																
H3B	Pulsar operation method	K0	Sets the single and interpolation patterns for the positioning operation. 0: Standard operation 1: Speed limit (Pulse held) Speed limit (Round down) Any other settings will be errors.																
H3C	Reserved for system	—	—																
H3D	Home return stop-on-contact torque value	K100	It is used when the stop-on-contact method 1 or 2 has been specified for the home return method. It is regarded as a criterion for judging the home return once the torque value of the AMP exceeded this set value by the stop-on-contact. Setting range: 0-5000 (0.1%)																
H3E	Home return stop-on-contact judgment time	K100	It is used when the stop-on-contact method 1 or 2 has been specified for the home return method. It is regarded as a criterion for judging the home return once this set time has passed after the torque value of the AMP exceeded the "home return stop-on-contact torque value" by the stop-on-contact. Setting range: 0-10000 (ms)																
H3F-H40	Reserved for system	—	—																
H41	J-point control code	H0	Sets the control code for the J point control.																
			<table border="1"> <thead> <tr> <th>bit</th> <th>Name</th> <th>Default</th> <th>Description</th> </tr> </thead> <tbody> <tr> <td>0</td> <td>—</td> <td>—</td> <td>—</td> </tr> <tr> <td>1</td> <td>Acceleration/ deceleration pattern setting</td> <td>0</td> <td>0: Linear acceleration/deceleration 1: S-shaped acceleration/deceleration</td> </tr> <tr> <td>15-2</td> <td>—</td> <td>—</td> <td>—</td> </tr> </tbody> </table>	bit	Name	Default	Description	0	—	—	—	1	Acceleration/ deceleration pattern setting	0	0: Linear acceleration/deceleration 1: S-shaped acceleration/deceleration	15-2	—	—	—
			bit	Name	Default	Description													
			0	—	—	—													
1	Acceleration/ deceleration pattern setting	0	0: Linear acceleration/deceleration 1: S-shaped acceleration/deceleration																
15-2	—	—	—																
—	—	—																	
—	—	—																	
H42	J-point acceleration time	K100	Sets the acceleration/deceleration time when performing the J-point control. Setting range: 0-10,000 (ms) Any other settings will be errors.																
H43	J-point deceleration time																		
H44-H45	J-point target speed	K1000	Set the target speed when performing the J-point control. Setting range: 1-2,147,482,624 Any other settings will be errors. The ranges vary depending on the unit settings as below. pulse: 1-2,147,482,624 pps µm: 1-2,147,482,624 µm/s inch: 0.001-2,147,482.624 inch/s degree: 0.001-2,147,482.624 rev/s																
H46-H47	Reserved for system	—	—																
H48-H49	Pulsar operation maximum speed	K0	The maximum speed when selecting the speed limit for the pulsar operation method. When the speed calculated by multiplying the pulsar input by (Pulsar operation numerator / Pulsar operation denominator) is over the specified maximum speed, the operation is performed at the maximum speed. Unit: Setting unit X1000/s Input range: 0-2,147,482,624																
H4A-H4B	Coordinate origin	—	Stores coordinate origin after home return.																
H4C-H4 F	Reserved for system	—	—																

■ Positioning data setting area

For details of the starting addresses of each positioning table, refer to the list on page 26-46 and after.

Offset Address	Name	Default	Setting range and description			
H0	Control code	H0	Sets the position setting mode and acceleration/deceleration pattern for the positioning operation.			
			bit	Name	Default	Description
			0	Increment/absolute setting	H0	0: Increment mode 1: Absolute mode
			1	Acceleration/deceleration pattern setting	H0	0: Linear acceleration/deceleration 1: S-shaped acceleration/deceleration
15-2	—	—	—			
H1	Operation pattern	H0	Sets the single and interpolation patterns for the positioning operation. The relation of the interpolation depends on the settings in the axis group setting area in the common area of the positioning unit memory. In the interpolation operation, the setting for the axis with the smallest number in an axis group is effective.			
			bit	Name	Default	Description
			7-0	Control pattern	H0	H0: E-point control (End point control) H1: P-point control (Pass point control) H2: C-point control (Continuance point control) H3: J-point control (Speed point control) Any other settings will be errors.
15-8	Interpolation setting	H0	H0: Linear interpolation (Composite speed) H1: Linear interpolation (Long axis speed) H10: Circular interpolation (Center point/CW direction) H11: Circular interpolation (Center point/CCW direction) H20: Circular interpolation (Pass point): H50: Spiral interpolation (Center point/CW direction/X-axis movemet) H51: Spiral interpolation (Center point/CCW direction/X-axis movemet) H52: Spiral interpolation (Center point/CW direction/Y-axis movemet) H53: Spiral interpolation (Center point/CCW direction/Y-axis movemet) H54: Spiral interpolation (Center point/CW direction/Z-axis movemet) H55: Spiral interpolation (Center point/CCW direction/Z-axis movemet) H60: Spiral interpolation (Pass point/X-axis movement) H61: Spiral interpolation (Pass point/Y-axis movement) H62: Spiral interpolation (Pass point/Z-axis movement) Any other settings will be errors.			
H2-H3	Reserved for system	—	—			
H4	Positioning acceleration time	K100	Sets the acceleration and deceleration time for the positioning operation. The acceleration time and deceleration time can be set individually. In the interpolation operation, the setting for the axis with the smallest number in an axis group is effective. Setting range: 0-10,000 (ms) Any other settings will be errors.			
H5	Positioning deceleration time					

Offset Address	Name	Default	Setting range and description
H6-H7	Positioning target speed (Interpolation speed)	K1000	In case of the individual operation (no interpolation), it is the target speed of the corresponding axis. In case of the interpolation operation, it is the target speed of the interpolation. In the interpolation operation, the setting for the axis with the smallest number in an axis group is effective. Range: 1-2,147,482,624 Any other settings will be errors. The ranges vary depending on the unit settings as below. pulse: 1-2,147,482,624 pps µm: 1-2,147,482,624 µm/s inch: 0.001-2,147,482.624 inch/s degree: 0.001-2,147,482.624 rev/s
H8-H9	Positioning movement amount	K0	Sets the movement amount for the positioning operation. The interpretation changes between the increment movement amount and absolute coordinate depending on the control code setting. Range: -2,147,482,624-2,147,482,624 Any other settings will be errors. The ranges vary depending on the unit settings as below. pulse: - 2,147,482,624-2,147,482,624 pulse µm (0.1 µm): - 214,748,262.4-214,748,262.4 µm µm (1 µm): - 2,147,482,624-2,147,482,624 µm inch (0.00001 inch): - 21,474.82624-21,474.82624 inch inch (0.0001 inch): - 214,748.2624-214,748.2624 inch degree (0.1 degree): - 214,748,262.4-214,748,262.4 degree degree (1 degree): - 2,147,482,624-2,147,482,624 degree
HA-HB	Auxiliary point	K0	Sets the auxiliary points (center point, pass point coordinates) in case of the circular interpolation or spiral interpolation control. Range: -2,147,482,624-2,147,482,624 Any other settings will be errors. The ranges vary depending on the unit settings as below. pulse: - 2,147,482,624-2,147,482,624 pulse µm (0.1 µm): - 214,748,262.4-214,748,262.4 µm µm (1 µm): - 2,147,482,624-2,147,482,624 µm inch (0.00001 inch): - 21,474.82624-21,474.82624 inch inch (0.0001 inch): - 214,748.2624-214,748.2624 inch degree (0.1 degree): - 214,748,262.4-214,748,262.4 degree degree (1 degree): - 2,147,482,624-2,147,482,624 degree
HC	Dwell time	K0	After the completion of the positioning control of this table, when the mode is C: Continuation point, stops the motor operation for the dwell time and starts the operation of the next table. When the mode is P: Pass point, this setting is ignored. When the mode is E: End point, the operation done flag will turn on after waiting for the dwell time. Setting range: 0-32,767 (ms) Any other settings will be errors.
HD	Auxiliary output code	K0	Sets the data to be output to the auxiliary output code in each axis information & monitor area by the setting of the auxiliary output mode in the parameter setting area.
HE-HF	Reserved for system	—	—



◆ KEY POINTS

- The positioning memory address allocated to each item of the positioning table comprises the address allocated to each axis and each table and the offset address.

■ Starting addresses of positioning tables (Standard tables 1 to 200)

Table no.	Starting address	Table no.	Starting address	Table no.	Starting address	Table no.	Starting address	Table no.	Starting address
1	H50	41	H2D0	81	H550	121	H7D0	161	HA50
2	H60	42	H2E0	82	H560	122	H7E0	162	HA60
3	H70	43	H2F0	83	H570	123	H7F0	163	HA70
4	H80	44	H300	84	H580	124	H800	164	HA80
5	H90	45	H310	85	H590	125	H810	165	HA90
6	HA0	46	H320	86	H5A0	126	H820	166	HAA0
7	HB0	47	H330	87	H5B0	127	H830	167	HAB0
8	HC0	48	H340	88	H5C0	128	H840	168	HAC0
9	HD0	49	H350	89	H5D0	129	H850	169	HAD0
10	HE0	50	H360	90	H5E0	130	H860	170	HAEO
11	HF0	51	H370	91	H5F0	131	H870	171	HAFO
12	H100	52	H380	92	H600	132	H880	172	HB00
13	H110	53	H390	93	H610	133	H890	173	HB10
14	H120	54	H3A0	94	H620	134	H8A0	174	HB20
15	H130	55	H3B0	95	H630	135	H8B0	175	HB30
16	H140	56	H3C0	96	H640	136	H8C0	176	HB40
17	H150	57	H3D0	97	H650	137	H8D0	177	HB50
18	H160	58	H3E0	98	H660	138	H8E0	178	HB60
19	H170	59	H3F0	99	H670	139	H8F0	179	HB70
20	H180	60	H400	100	H680	140	H900	180	HB80
21	H190	61	H410	101	H690	141	H910	181	HB90
22	H1A0	62	H420	102	H6A0	142	H920	182	HBA0
23	H1B0	63	H430	103	H6B0	143	H930	183	HBB0
24	H1C0	64	H440	104	H6C0	144	H940	184	HBC0
25	H1D0	65	H450	105	H6D0	145	H950	185	HBD0
26	H1E0	66	H460	106	H6E0	146	H960	186	HBE0
27	H1F0	67	H470	107	H6F0	147	H970	187	HBF0
28	H200	68	H480	108	H700	148	H980	188	HC00
29	H210	69	H490	109	H710	149	H990	189	HC10
30	H220	70	H4A0	110	H720	150	H9A0	190	HC20
31	H230	71	H4B0	111	H730	151	H9B0	191	HC30
32	H240	72	H4C0	112	H740	152	H9C0	192	HC40
33	H250	73	H4D0	113	H750	153	H9D0	193	HC50
34	H260	74	H4E0	114	H760	154	H9E0	194	HC60
35	H270	75	H4F0	115	H770	155	H9F0	195	HC70
36	H280	76	H500	116	H780	156	HA00	196	HC80
37	H290	77	H510	117	H790	157	HA10	197	HC90
38	H2A0	78	H520	118	H7A0	158	HA20	198	HCA0
39	H2B0	79	H530	119	H7B0	159	HA30	199	HCB0
40	H2C0	80	H540	120	H7C0	160	HA40	200	HCC0

■ Starting addresses of positioning tables (Standard tables 201 to 400)

Table no.	Starting address	Table no.	Starting address	Table no.	Starting address	Table no.	Starting address	Table no.	Starting address
201	HCD0	241	HF50	281	H11D0	321	H1450	361	H16D0
202	HCE0	242	HF60	282	H11E0	322	H1460	362	H16E0
203	HCF0	243	HF70	283	H11F0	323	H1470	363	H16F0
204	HD00	244	HF80	284	H1200	324	H1480	364	H1700
205	HD10	245	HF90	285	H1210	325	H1490	365	H1710
206	HD20	246	HFA0	286	H1220	326	H14A0	366	H1720
207	HD30	247	HFB0	287	H1230	327	H14B0	367	H1730
208	HD40	248	HFC0	288	H1240	328	H14C0	368	H1740
209	HD50	249	HFD0	289	H1250	329	H14D0	369	H1750
210	HD60	250	HFE0	290	H1260	330	H14E0	370	H1760
211	HD70	251	HFF0	291	H1270	331	H14F0	371	H1770
212	HD80	252	H1000	292	H1280	332	H1500	372	H1780
213	HD90	253	H1010	293	H1290	333	H1510	373	H1790
214	HDA0	254	H1020	294	H12A0	334	H1520	374	H17A0
215	HDB0	255	H1030	295	H12B0	335	H1530	375	H17B0
216	HDC0	256	H1040	296	H12C0	336	H1540	376	H17C0
217	HDD0	257	H1050	297	H12D0	337	H1550	377	H17D0
218	HDE0	258	H1060	298	H12E0	338	H1560	378	H17E0
219	HDF0	259	H1070	299	H12F0	339	H1570	379	H17F0
220	HE00	260	H1080	300	H1300	340	H1580	380	H1800
221	HE10	261	H1090	301	H1310	341	H1590	381	H1810
222	HE20	262	H10A0	302	H1320	342	H15A0	382	H1820
223	HE30	263	H10B0	303	H1330	343	H15B0	383	H1830
224	HE40	264	H10C0	304	H1340	344	H15C0	384	H1840
225	HE50	265	H10D0	305	H1350	345	H15D0	385	H1850
226	HE60	266	H10E0	306	H1360	346	H15E0	386	H1860
227	HE70	267	H10F0	307	H1370	347	H15F0	387	H1870
228	HE80	268	H1100	308	H1380	348	H1600	388	H1880
229	HE90	269	H1110	309	H1390	349	H1610	389	H1890
230	HEA0	270	H1120	310	H13A0	350	H1620	390	H18A0
231	HEB0	271	H1130	311	H13B0	351	H1630	391	H18B0
232	HEC0	272	H1140	312	H13C0	352	H1640	392	H18C0
233	HED0	273	H1150	313	H13D0	353	H1650	393	H18D0
234	HEE0	274	H1160	314	H13E0	354	H1660	394	H18E0
235	HEF0	275	H1170	315	H13F0	355	H1670	395	H18F0
236	HF00	276	H1180	316	H1400	356	H1680	396	H1900
237	HF10	277	H1190	317	H1410	357	H1690	397	H1910
238	HF20	278	H11A0	318	H1420	358	H16A0	398	H1920
239	HF30	279	H11B0	319	H1430	359	H16B0	399	H1930
240	HF40	280	H11C0	320	H1440	360	H16C0	400	H1940

■ Starting addresses of positioning tables (Standard tables 401 to 600)

Table no.	Starting address	Table no.	Starting address	Table no.	Starting address	Table no.	Starting address	Table no.	Starting address
401	H1950	441	H1BD0	481	H1E50	521	H20D0	561	H2350
402	H1960	442	H1BE0	482	H1E60	522	H20E0	562	H2360
403	H1970	443	H1BF0	483	H1E70	523	H20F0	563	H2370
404	H1980	444	H1C00	484	H1E80	524	H2100	564	H2380
405	H1990	445	H1C10	485	H1E90	525	H2110	565	H2390
406	H19A0	446	H1C20	486	H1EA0	526	H2120	566	H23A0
407	H19B0	447	H1C30	487	H1EB0	527	H2130	567	H23B0
408	H19C0	448	H1C40	488	H1EC0	528	H2140	568	H23C0
409	H19D0	449	H1C50	489	H1ED0	529	H2150	569	H23D0
410	H19E0	450	H1C60	490	H1EE0	530	H2160	570	H23E0
411	H19F0	451	H1C70	491	H1EF0	531	H2170	571	H23F0
412	H1A00	452	H1C80	492	H1F00	532	H2180	572	H2400
413	H1A10	453	H1C90	493	H1F10	533	H2190	573	H2410
414	H1A20	454	H1CA0	494	H1F20	534	H21A0	574	H2420
415	H1A30	455	H1CB0	495	H1F30	535	H21B0	575	H2430
416	H1A40	456	H1CC0	496	H1F40	536	H21C0	576	H2440
417	H1A50	457	H1CD0	497	H1F50	537	H21D0	577	H2450
418	H1A60	458	H1CE0	498	H1F60	538	H21E0	578	H2460
419	H1A70	459	H1CF0	499	H1F70	539	H21F0	579	H2470
420	H1A80	460	H1D00	500	H1F80	540	H2200	580	H2480
421	H1A90	461	H1D10	501	H1F90	541	H2210	581	H2490
422	H1AA0	462	H1D20	502	H1FA0	542	H2220	582	H24A0
423	H1AB0	463	H1D30	503	H1FB0	543	H2230	583	H24B0
424	H1AC0	464	H1D40	504	H1FC0	544	H2240	584	H24C0
425	H1AD0	465	H1D50	505	H1FD0	545	H2250	585	H24D0
426	H1AE0	466	H1D60	506	H1FE0	546	H2260	586	H24E0
427	H1AF0	467	H1D70	507	H1FF0	547	H2270	587	H24F0
428	H1B00	468	H1D80	508	H2000	548	H2280	588	H2500
429	H1B10	469	H1D90	509	H2010	549	H2290	589	H2510
430	H1B20	470	H1DA0	510	H2020	550	H22A0	590	H2520
431	H1B30	471	H1DB0	511	H2030	551	H22B0	591	H2530
432	H1B40	472	H1DC0	512	H2040	552	H22C0	592	H2540
433	H1B50	473	H1DD0	513	H2050	553	H22D0	593	H2550
434	H1B60	474	H1DE0	514	H2060	554	H22E0	594	H2560
435	H1B70	475	H1DF0	515	H2070	555	H22F0	595	H2570
436	H1B80	476	H1E00	516	H2080	556	H2300	596	H2580
437	H1B90	477	H1E10	517	H2090	557	H2310	597	H2590
438	H1BA0	478	H1E20	518	H20A0	558	H2320	598	H25A0
439	H1BB0	479	H1E30	519	H20B0	559	H2330	599	H25B0
440	H1BC0	480	H1E40	520	H20C0	560	H2340	600	H25C0

■ Starting addresses of positioning tables (Expansion tables 10001 to 10089)

Table no.	Starting address	Table no.	Starting address	Table no.	Starting address	Table no.	Starting address	Table no.	Starting address
10001	H2670	10021	H27B0	10041	H28F0	10061	H2A30	10081	H2B70
10002	H2680	10022	H27C0	10042	H2900	10062	H2A40	10082	H2B80
10003	H2690	10023	H27D0	10043	H2910	10063	H2A50	10083	H2B90
10004	H26A0	10024	H27E0	10044	H2920	10064	H2A60	10084	H2BA0
10005	H26B0	10025	H27F0	10045	H2930	10065	H2A70	10085	H2BB0
10006	H26C0	10026	H2800	10046	H2940	10066	H2A80	10086	H2BC0
10007	H26D0	10027	H2810	10047	H2950	10067	H2A90	10087	H2BD0
10008	H26E0	10028	H2820	10048	H2960	10068	H2AA0	10088	H2BE0
10009	H26F0	10029	H2830	10049	H2970	10069	H2AB0	10089	H2BF0
10010	H2700	10030	H2840	10050	H2980	10070	H2AC0		
10011	H2710	10031	H2850	10051	H2990	10071	H2AD0		
10012	H2720	10032	H2860	10052	H29A0	10072	H2AE0		
10013	H2730	10033	H2870	10053	H29B0	10073	H2AF0		
10014	H2740	10034	H2880	10054	H29C0	10074	H2B00		
10015	H2750	10035	H2890	10055	H29D0	10075	H2B10		
10016	H2760	10036	H28A0	10056	H29E0	10076	H2B20		
10017	H2770	10037	H28B0	10057	H29F0	10077	H2B30		
10018	H2780	10038	H28C0	10058	H2A00	10078	H2B40		
10019	H2790	10039	H28D0	10059	H2A10	10079	H2B50		
10020	H27A0	10040	H28E0	10060	H2A20	10080	H2B60		

26.4.5 Cam Pattern Editing Area (Memory Area No. 3)

■ Cam pattern setting area

Offset address	Name	Default	Description								
H0	Cam pattern no.	K0	<p>When reading: Set a cam pattern number to be read out. When rewriting: Set a cam pattern number to be rewritten. The setting range varies depending on resolutions.</p> <table border="1"> <thead> <tr> <th>Pattern resolution</th> <th>Settable range</th> </tr> </thead> <tbody> <tr> <td>1024, 2048, 4096, 8192</td> <td>K1-K16</td> </tr> <tr> <td>16384</td> <td>K1- K8</td> </tr> <tr> <td>32768</td> <td>K1-K4</td> </tr> </tbody> </table>	Pattern resolution	Settable range	1024, 2048, 4096, 8192	K1-K16	16384	K1- K8	32768	K1-K4
Pattern resolution	Settable range										
1024, 2048, 4096, 8192	K1-K16										
16384	K1- K8										
32768	K1-K4										
H1	Reserved for system	—	—								
H2	No. of cam pattern setting sections	K0	<p>When reading, stores the number of setting sections of the read cam pattern table. When rewriting, stores the number of setting sections of the rewritten cam pattern table. Setting range: K1-K20</p>								
H3	Shift amount	K0	<p>When reading, stores the shift amount of the read cam pattern table. When rewriting, stores the shift amount of the rewritten cam pattern table. Setting range: K0-K10000 x (0.01%)</p>								
H4	Start phase of section 1	K0	<ul style="list-style-type: none"> •When reading, stores the start phase in the section 1 of the read cam pattern table. The read value is always 0. •When rewriting, stores the start phase in the section 1 of the rewritten cam pattern table. When any value other than 0 is set in the section 1, it cannot be rewritten correctly. <p>Setting range: (Decimal) 0-10000 (x0.01%)</p> <p>When reading, stores it truncating the numbers beyond the third decimal point. When writing, registers it after calculating the numbers beyond the third decimal point by the unit.</p>								
H5	Displacement of section 1	K0	<ul style="list-style-type: none"> •When reading, stores the displacement in the section 1 of the read cam pattern table. •When rewriting, stores the displacement in the section 1 of the rewritten cam pattern table. <p>Setting range: (Decimal): -10000-10000 (x0.01%)</p> <p>When reading, stores it truncating the numbers beyond the third decimal point. When writing, stores it filling the numbers beyond the third decimal point with 0.</p>								

Offset address	Name	Default	Description																																												
H6	Cam pattern of section 1	K0	When reading, stores the cam pattern number of the read cam pattern table. When rewriting, sets the cam pattern number of the rewritten cam pattern table.																																												
			<table border="1"> <thead> <tr> <th>Set value</th> <th>Cam pattern name</th> <th>Set value</th> <th>Cam pattern name</th> </tr> </thead> <tbody> <tr> <td>K10</td> <td>Constant speed</td> <td>K43</td> <td>One-dwell cycloid m=1</td> </tr> <tr> <td>K11</td> <td>Constant acceleration</td> <td>K44</td> <td>One-dwell cycloidl m=2/3</td> </tr> <tr> <td>K12</td> <td>Simple harmonic motion</td> <td>K45</td> <td>One-dwell modified trapezoid m=1</td> </tr> <tr> <td>K22</td> <td>Cycloid</td> <td>K46</td> <td>One-dwell modified trapezoid (Ferguson)</td> </tr> <tr> <td>K25</td> <td>Modified trapezoid</td> <td>K47</td> <td>One-dwell modified trapezoid m=2/3</td> </tr> <tr> <td>K26</td> <td>Modified sine</td> <td>K48</td> <td>One-dwell modified sine</td> </tr> <tr> <td>K27</td> <td>Modified uniform velocity</td> <td>K49</td> <td>One-dwell trapezoid</td> </tr> <tr> <td>K33</td> <td>Asymmetric cycloid</td> <td>K51</td> <td>No-dwell modified trapezoid</td> </tr> <tr> <td>K34</td> <td>Asymmetric modified trapezoid</td> <td>K52</td> <td>No-dwell modified uniform velocity</td> </tr> <tr> <td>K35</td> <td>Trapezoid</td> <td>K92</td> <td>NC2 curve</td> </tr> </tbody> </table>	Set value	Cam pattern name	Set value	Cam pattern name	K10	Constant speed	K43	One-dwell cycloid m=1	K11	Constant acceleration	K44	One-dwell cycloidl m=2/3	K12	Simple harmonic motion	K45	One-dwell modified trapezoid m=1	K22	Cycloid	K46	One-dwell modified trapezoid (Ferguson)	K25	Modified trapezoid	K47	One-dwell modified trapezoid m=2/3	K26	Modified sine	K48	One-dwell modified sine	K27	Modified uniform velocity	K49	One-dwell trapezoid	K33	Asymmetric cycloid	K51	No-dwell modified trapezoid	K34	Asymmetric modified trapezoid	K52	No-dwell modified uniform velocity	K35	Trapezoid	K92	NC2 curve
			Set value	Cam pattern name	Set value	Cam pattern name																																									
			K10	Constant speed	K43	One-dwell cycloid m=1																																									
			K11	Constant acceleration	K44	One-dwell cycloidl m=2/3																																									
			K12	Simple harmonic motion	K45	One-dwell modified trapezoid m=1																																									
			K22	Cycloid	K46	One-dwell modified trapezoid (Ferguson)																																									
			K25	Modified trapezoid	K47	One-dwell modified trapezoid m=2/3																																									
			K26	Modified sine	K48	One-dwell modified sine																																									
			K27	Modified uniform velocity	K49	One-dwell trapezoid																																									
			K33	Asymmetric cycloid	K51	No-dwell modified trapezoid																																									
			K34	Asymmetric modified trapezoid	K52	No-dwell modified uniform velocity																																									
			K35	Trapezoid	K92	NC2 curve																																									
H7	Reserved for system	—	—																																												
H8-HB	Area for section 2	—	<p>Just like the area for the section 1, one word each is allocated to the start phase, displacement, cam pattern and the system area.</p> <table border="1"> <thead> <tr> <th></th> <th>Start phase in section</th> <th>Displacement in section</th> <th>Cam pattern in section</th> <th>Reserved for system</th> </tr> </thead> <tbody> <tr> <td rowspan="4">The end of offset address</td> <td>Hx0</td> <td>Hx1</td> <td>Hx2</td> <td>Hx3</td> </tr> <tr> <td>Hx4</td> <td>Hx5</td> <td>Hx6</td> <td>Hx7</td> </tr> <tr> <td>Hx8</td> <td>Hx9</td> <td>HxA</td> <td>HxB</td> </tr> <tr> <td>HxC</td> <td>HxD</td> <td>HxE</td> <td>HxF</td> </tr> </tbody> </table>		Start phase in section	Displacement in section	Cam pattern in section	Reserved for system	The end of offset address	Hx0	Hx1	Hx2	Hx3	Hx4	Hx5	Hx6	Hx7	Hx8	Hx9	HxA	HxB	HxC	HxD	HxE	HxF																						
	Start phase in section	Displacement in section		Cam pattern in section	Reserved for system																																										
The end of offset address	Hx0	Hx1		Hx2	Hx3																																										
	Hx4	Hx5		Hx6	Hx7																																										
	Hx8	Hx9		HxA	HxB																																										
	HxC	HxD		HxE	HxF																																										
HC-HF	Area for section 3	—																																													
H10-H13	Area for section 4	—																																													
H14-H17	Area for section 5	—																																													
H18-H1B	Area for section 6	—																																													
H1C-H1F	Area for section 7	—																																													
H20-H23	Area for section 8	—																																													
H24-H27	Area for section 9	—																																													
H28-H2B	Area for section 10	—																																													
H2C-H2F	Area for section 11	—																																													
H30-H33	Area for section 12	—																																													
H34-H37	Area for section 13	—																																													
H38-H3B	Area for section 14	—																																													
H3C-H3F	Area for section 15	—																																													
H40-H43	Area for section 16	—																																													
H44-H47	Area for section 17	—																																													
H48-H4B	Area for section 18	—																																													
H4C-H4F	Area for section 19	—																																													
H50-H53	Area for section 20	—																																													
H54-H57	Reserved for system	—																																													

■ Cam pattern reading/rewriting execution confirmation area

Offset address	Name	Default	Description
H58	Cam pattern reading result	H0	Stores the result of reading processing (response code). H0: Normal end Other than H0: Abnormal end
H59	Cam pattern rewriting result	H0	Stores the result of rewriting processing (response code). H0: Normal end Other than H0: Abnormal end

(Note): In the case of abnormal end, the codes in the following table are stored.

A: Available, -: Not available

Code	Name	Description	Object		Countermeasures
			Read	Write	
H FF01	Cam pattern number setting error	The set value of the cam pattern number is out of the settable range.	A	A	Check the set value of the cam pattern number.
H FF02	Number of cam pattern setting sections setting error	The set number of cam pattern setting sections is out of the settable range.	-	A	Check the set number of setting sections.
H FF03	Shift amount setting error	The set shift amount is out of the settable range.	-	A	Check the set value of the shift amount.
H FF05	Start phase setting error 1	The set start phase is out of the settable range.	-	A	Check the set value of the start phase in each section.
H FF06	Start phase setting error 2	The set start phase is the same as or smaller than the start phase of the previous section.	-	A	Check if the relation between the start phases of each section is (Start phase of section n-1) < (Start phase of section n).
H FF07	Start phase setting error 3	The set start phase of the section 1 is not 0.	-	A	Always set the start phase of the section 1 to 0.
H FF0A	Displacement setting error	The set value of the displacement is out of the settable range.	-	A	Check the set value of the phase in each section.
H FF0B	Cam pattern number setting error	The set cam pattern number is out of the settable range.	-	A	Check the set value of the cam pattern number in each section.
H FF10	Cam pattern reading not executable error 1	An axis in synchronous operation exists.	A	-	Cancel the synchronous operation and execute the reading.
H FF11	Cam pattern reading not executable error 2	An operating axis exists.	A	-	Execute the reading when no operating axis exists.
H FF20	Cam pattern rewriting not executable error 1	An axis in synchronous operation exists.	-	A	Cancel the synchronous operation and execute the rewriting.
H FF21	Cam pattern rewriting not executable error 2	An operating axis exists.	-	A	Execute the rewriting when no operating axis exists.
H FF22	Cam pattern rewriting not executable error 3	The reading request and rewriting request turned on simultaneously.	-	A	Check if the reading request and rewriting request do not turn on simultaneously. When the reading request and rewriting request turn on simultaneously, the reading request takes priority.

Unit memory No. (Hex)	Name	Default	Description			
H5A	Cam pattern update flag	HFFFF	Announces the valid cam pattern table data. Bits are allocated to the cam pattern numbers 1 to 15. All the bits of bit0 to bit15 turn to "1" when the mode of the unit changes to the RUN mode and the configuration data set by the tool software becomes valid. When a cam pattern is rewritten by a user program, the bit of a corresponding cam pattern number turns to "0". (*) Do not rewrite this area. If rewritten, the condition cannot be announced properly.			
			bit no.	Name	Default	Description
			0	Cam pattern No.1 valid condition	1	0: Cam pattern table after rewriting by user program is valid. 1: Configuration data by tool software is valid.
			1	Cam pattern No.2 valid condition	1	
			2	Cam pattern No.3 valid condition	1	
			3	Cam pattern No.4 valid condition	1	
			4	Cam pattern No.5 valid condition	1	
			5	Cam pattern No.6 valid condition	1	
			6	Cam pattern No.7 valid condition	1	
			7	Cam pattern No.8 valid condition	1	
			8	Cam pattern No.9 valid condition	1	
			9	Cam pattern No.10 valid condition	1	
			10	Cam pattern No.11 valid condition	1	
			11	Cam pattern No.12 valid condition	1	
			12	Cam pattern No.13 valid condition	1	
			13	Cam pattern No.14 valid condition	1	
			14	Cam pattern No.15 valid condition	1	
15	Cam pattern No.16 valid condition	1				

26.4.6 Synchronous Control Area (Memory Area No. 4)

■ Synchronous control common setting area

Offset address	Name	Default	Description																												
H0	Synchronous master axis selection of each axis	H0	<p>Set the master axis for each axis.</p> <table border="1"> <thead> <tr> <th>Set value</th> <th>Master axis</th> </tr> </thead> <tbody> <tr> <td>H0</td> <td>No synchronous master axis or the setting target axis is the master axis.</td> </tr> <tr> <td>H1</td> <td>Axis 1</td> </tr> <tr> <td>H2</td> <td>Axis 2</td> </tr> <tr> <td>H3</td> <td>Axis 3</td> </tr> <tr> <td>H4</td> <td>Axis 4</td> </tr> <tr> <td>H5</td> <td>Axis 5</td> </tr> <tr> <td>H6</td> <td>Axis 6</td> </tr> <tr> <td>H7</td> <td>Axis 7 (virtual)</td> </tr> <tr> <td>H8</td> <td>Axis 8 (virtual)</td> </tr> <tr> <td>H21</td> <td>Pulse input 1</td> </tr> <tr> <td>H22</td> <td>Pulse input 2</td> </tr> <tr> <td>H23</td> <td>Pulse input 3</td> </tr> <tr> <td>H24</td> <td>Pulse input 4</td> </tr> </tbody> </table>	Set value	Master axis	H0	No synchronous master axis or the setting target axis is the master axis.	H1	Axis 1	H2	Axis 2	H3	Axis 3	H4	Axis 4	H5	Axis 5	H6	Axis 6	H7	Axis 7 (virtual)	H8	Axis 8 (virtual)	H21	Pulse input 1	H22	Pulse input 2	H23	Pulse input 3	H24	Pulse input 4
Set value	Master axis																														
H0	No synchronous master axis or the setting target axis is the master axis.																														
H1	Axis 1																														
H2	Axis 2																														
H3	Axis 3																														
H4	Axis 4																														
H5	Axis 5																														
H6	Axis 6																														
H7	Axis 7 (virtual)																														
H8	Axis 8 (virtual)																														
H21	Pulse input 1																														
H22	Pulse input 2																														
H23	Pulse input 3																														
H24	Pulse input 4																														
H1	Synchronous output function selection of each axis	H0	<p>Stores the status of the synchronous operation function set for the axes.</p> <table border="1"> <thead> <tr> <th>bit</th> <th>Function</th> <th>Setting</th> </tr> </thead> <tbody> <tr> <td>0</td> <td>Electronic gear operation settings</td> <td rowspan="4">0: Not use 1: Use</td> </tr> <tr> <td>1</td> <td>Clutch operation setting</td> </tr> <tr> <td>2</td> <td>Electronic operation setting</td> </tr> <tr> <td>3</td> <td>Advance angle correction synchronous setting</td> </tr> <tr> <td>15-4</td> <td>Reserved area for the system</td> <td></td> </tr> </tbody> </table>	bit	Function	Setting	0	Electronic gear operation settings	0: Not use 1: Use	1	Clutch operation setting	2	Electronic operation setting	3	Advance angle correction synchronous setting	15-4	Reserved area for the system														
bit	Function	Setting																													
0	Electronic gear operation settings	0: Not use 1: Use																													
1	Clutch operation setting																														
2	Electronic operation setting																														
3	Advance angle correction synchronous setting																														
15-4	Reserved area for the system																														
H2	Synchronous slave single deceleration stop deceleration method of each axis	H0	<p>Set the deceleration method when performing the deceleration stop during the synchronous operation.</p> <table border="1"> <thead> <tr> <th>bit</th> <th>Name</th> <th>Default</th> <th>Description</th> </tr> </thead> <tbody> <tr> <td>0</td> <td>Not used</td> <td></td> <td></td> </tr> <tr> <td>1</td> <td>Deceleration method</td> <td>H0</td> <td>0: Linear 1: S-shaped</td> </tr> <tr> <td>15-2</td> <td>Reserved area for the system</td> <td>—</td> <td>—</td> </tr> </tbody> </table>	bit	Name	Default	Description	0	Not used			1	Deceleration method	H0	0: Linear 1: S-shaped	15-2	Reserved area for the system	—	—												
bit	Name	Default	Description																												
0	Not used																														
1	Deceleration method	H0	0: Linear 1: S-shaped																												
15-2	Reserved area for the system	—	—																												
H3	Synchronous slave single deceleration stop deceleration time of each axis	H0	<p>Set the deceleration time when performing the deceleration stop during the synchronous operation. Setting range: 0-10,000 (ms) Any other settings will be errors.</p>																												
H4-HF	Reserved for system	—	—																												

■ Electronic gear setting area

Offset Address	Name	Initial value	Description
H10-H11	Gear ratio numerator of each axis	K1	K1-K 2147483647
H12-H13	Gear ratio denominator of each axis	K1	K1-K2147483647
H14	Gear ratio change time of each axis	K1	K1-K10000
H15-H1F	Reserved for system	—	—

■ Clutch setting area

Offset address	Name	Default	Description
H20	Clutch ON trigger type	H0	H0: I/O clutch ON request
H21	Clutch ON edge selection	H0	Set the valid condition of trigger signals. H0: Level H1: Leading edge H2: Trailing edge
H22-H27	Reserved for system	—	—
H28	Clutch OFF trigger type	H00	H00: I/O clutch OFF request H11: I/O + Phase after clutch control clutch OFF
H29	Clutch OFF edge selection	H0	Set the valid condition of trigger signals. H0: Level H1: Leading edge H2: Trailing edge When selecting "H0: Level" for the clutch ON edge selection (offset address H21), set "H0: Level" in this area (offset address H29).
H2A	Clutch OFF phase ratio	H0	Set the ratio for the phase at which the clutch turns OFF when selecting "I/O + Phase after clutch control" for the clutch off trigger type. Setting range: 0-99 (%)
H2B-H2F	Reserved for system	—	—
H30	Clutch ON method	H0	H0: Direct H1: Slip
H31	Reserved for system	—	—
H32	Clutch ON slip method	H0	H0: Slip time setting
H33	Clutch ON slip time	K1	1-10000 ms
H34-H35	Reserved for system	—	—
H36	Clutch ON slip curve selection	H0	H0: Linear
H37-H3F	Reserved for system	—	—
H40	Clutch OFF method	H0	H0: Direct H1: Slip
H41	Reserved for system	—	—
H42	Clutch OFF slip method	H0	H0: Slip time setting
H43	Clutch OFF slip time	K1	1-10000 ms
H44-H45	Reserved for system	—	—
H46	Clutch OFF slip curve selection	H0	H0: Linear
H47-H4F	Reserved for system	—	—

■ Electronic cam setting area

Offset address	Name	Default	Description
H50-H51	Cam control synchronous master axis cycle	K1	Set the cam control synchronous master cycle. K1 -K 2147483647
H52	Reserved for system	—	—
H53	Used cam pattern number	K1	Set the registered cam pattern number to be used. 1 - (16) The upper limit of the usable cam pattern numbers depends on the resolution.
H54-H55	Cam stroke amount	1	Set the upper limit of displacement for cam control. K1 - K2147483647
H56-H57	Advance angle correction reference amount	0	Set the correction reference amount for calculating the advance angle correction amount when using the advance angle correction function. Setting range: K-2,147,482,624-K2,147,482,624 The unit follows the unit system of the master axis. pulse: -2,147,482,624-2,147,482,624 pulse μm (0.1 μm): -214,748,262.4-214,748,262.4 μm μm (1 μm): -2,147,482,624-2,147,482,624 μm inch (0.00001 inch): -21,474.82624-21,474.82624 inch inch (0.0001 inch): -214,748.2624-214,748.2624 inch degree (0.1 degree): -214,748,262.4-214,748,262.4degree degree (1 degree): -2,147,482,624-2,147,482,624 degree
H58-H59	Advance angle correction reference speed	100	Set the reference speed for calculating the advance angle correction amount when using the advance angle correction function. Setting range: 1-2,147,482,624 (Specified unit system) The unit follows the unit system of the master axis. pulse: 1-2,147,482,624 pps μm : 1-2,147,482,624 $\mu\text{m/s}$ inch: 0.001-2,147,482.624 inch/s degree: 0.001-2,147,482.624 rev/s
H5A	Advance angle correction parameter change time	100	Set the time required until a changed value is reflected when the parameter related to advance angle correction (advance angle correction reference speed or advance angle correction reference amount) is changed during the electronic cam operation. Setting range: 1-10000ms
H5B-H6F	Reserved for system	—	—

26.4.7 Positioning Operation Change Setting Area (Memory Area No. 5)

Offset address	Name	Default	Description
H0	Positioning speed change Ratio specification(Override)	K100	Area for setting the change ratio (override) to the command speed for the positioning speed change. The speed change request by I/O is not necessary, and the change becomes valid when the set value (ratio) is set. Setting range: 1-300 (%)
H1	Positioning speed change Change mode selection	H0	Area for setting the range of the positioning speed change. 0000H: Active table only 0001H: Active table to E point table (until the completion of the operation) In the case of other values, the unit operates as the setting of 0000H (Active table only).
H2-H3	Positioning speed change Change speed	K100	Area for setting a change speed for changing the positioning speed. Set using unit system conversion values. Setting range: 1-2,147,482,624 (Specified unit system)
H4-H9	Reserved for system	—	—
HA-HB	Positioning movement amount change Change movement amount	K0	Area for setting a change movement amount for changing the positioning movement amount. Set using unit system conversion values. Setting range: K-2,147,482,624-K2,147,482,624
HC-HF	Reserved for system	—	—

26.4.8 AMP Parameter Control Area (Memory Area No. 6)

Offset address	Name	Default	Description
H0	AMP ID number	K1	Specify the target axis number (AMP ID no.) to perform each operation such as changing parameters. Setting range: K1-K8
H1	Control flag	H0	Specify the process of AMP parameters. This area will be set to 0H when the FP-X M8N Control Unit completes the processing. Setting range: K0-K6 H0: No request H2: Read request H4: Write request H5: EEPROM request H6: AMP reset request
H2	Status	H0	Stores the processing state of AMP parameters. H0: No operation H1: Being processed H2: Normal end (Read / Write / EEPROM / Reset) H3: Abnormal end (Read / Write / EEPROM / Reset) H4: ID error H5: Parameter error H6: Request execution disabled
H3	Parameter classification	K0	Specify the classification codes of the parameters for read/write. Setting range: K0-K8 No writing is required in this area when executing EEPROM write or AMP reset.
H24	Individual parameter no.	H0	Specify the parameter numbers for read/write. Setting range: H0-H7F Specify the parameter numbers in the classification code. No writing is required in this area when executing EEPROM write or AMP reset.
H26-H27	Parameter data	K0	Stores the data of parameters. When reading: Stores the parameter values of AMP. When writing: Stores the parameter values to be updated.

26.5 Table of System Registers

	No.	Name	Default	Sets value range and description
Memory allocation	0	Sequence program area size	32	24, 32, 40 K words (note 1)
	4	Leading edge differential during MC holds the previous value	Hold	Hold / non-hold
Hold / Non-hold	5	Counter starting address	1008	0 - 1024
	6	Hold type area starting address for timer/counter	1008	0 - 1024
	7	Hold type area starting address for internal relay	504	0 - 512
	8	Hold type area starting address for data registers (Note 2)	11970, 32450, 65218	0-12285 0-32765 0-65533
	10	Hold type area starting address setting for link relays for PLC link W0-0	64	0 - 64
	11	Hold type area starting address setting for link relays for PLC link W0-1	128	64 - 128
	12	Hold type area starting address setting for link data registers for PLC link W0-0	128	0 - 128
	13	Hold type area starting address setting for link data registers for PLC link W0-1	256	128 - 256
	14	Selection of hold / non-hold in the step ladder diagram program	Non-hold	Hold / non-hold
	Action on error	20	Selection of dual output (disable / enable)	Disable
23		Selection of operation mode (stop/run) in case of I/O verification error	Stop	Stop / run
24		Operation stop upon Initial error of the motion part	Stop	Stop / run
25		Selection of operation mode in case of position control operation error (stop / run)	Run	Run/stop
26		Selection of operation mode in case of operational error (stop / run)	Stop	Stop / run
28		Mode (stop/run) in case of AMP communication error of the motion part	Run	Stop / run
4		Selection of operation mode in case of battery error	Not execute	Not execute: Do not notify the self-diagnostic error when the battery is abnormal, the ERR.LED does not flash. Execute: Do not notify the self-diagnostic error when the battery is abnormal, the ERR.LED flashes.

Specifications

(Note 1): System register no. 0: can set the sequence program area capacity only in off-line editing. To make the setting effective, you need to download it to the control unit.

(Note 2): System register no.0: if you change the sequence program area capacity, the capacity of the data register DT will be changed.

(Note 3): System registers no.4-no.14: The data within the setting range of the register can be kept only when equipped with the optional battery. Use the initial values directly when the battery is not installed.

	No.	Name	Initial value	Sets value range and description
Time setting	31	Waiting time for managing multiple frame	6500.0 ms	10 - 81900 ms (unit: 2.5 ms)
	32	SEND/RECV, RMRD/RMWT Instruction Waiting Time	1000.0 ms	10 - 81900 ms (unit: 2.5 ms)
	34	Constant scan time	Normal scanning	0: normal scanning (unit: 0.5 ms) 0 - 350 ms: scan once at a specified time interval
	36	Expansion unit recognition time	0	0 - 10 seconds (unit: 0.1 second) 0: no waiting time
	37	Task time priority setting (note 1)	Normal	Normal /Operation
PC Link W0 — 0 Setting	40	Size of link relay	0	0 - 64 words
	41	Size of link register	0	0 - 128 words
	42	Send area starting word address of link relay	0	0 - 63
	43	Size of link relays used for send area	0	0 - 64 words
	44	Send area starting word address link data register	0	0 - 127
	45	Size of link data registers used for send area	0	0 - 127 words
	46	PLC link 0 and 1 allocation setting	Standard	Normal / reverse
	48	PLC link baud rate (note 2)	115200 bps	115200bps/230400bps
PC Link W0 — 1 Setting	50	Size of link relay	0	0 - 64 words
	51	Size of link register	0	0 - 128 words
	52	Send area starting word address of link relay	64	64 - 127
	53	Size of link relays used for send area	0	0 - 64 words
	54	Size of link data registers used for send area	128	128 - 255
	55	Size of link data registers used for send area	0	0 - 127 words
	57	MEWNET-W0 PLC link max unit no.	16	1 - 16

(Note 1): When the system register no. 37 task time is set as "Operation" preferentially, after every scan, the time required for the communication process is reduced to 1 port, the operation processing has priority.

(Note 2): The system register no. 48 PLC link baud rate is set in the same dialog box that the COM0 port and COM1 port setting used.

	No.	Name	Initial value	Sets value range and description
Master input setting 1 (HSC)	400	High-speed counter settings (X0-X3)	CH0: Not set X0 as High-speed counter	Not set X0 as High-speed counter addition input (X0) subtraction input (X0) 2-phase input (X0, X1) one input (X0, X1) direction distinction (X0, X1)
			CH1: Not set X1 as High-speed counter	Not set X1 as High-speed counter addition input (X1) subtraction input (X1)
			CH2: Not set X2 as High-speed counter	Not set X2 as High-speed counter addition input (X2) subtraction input (X2) 2-phase input (X2, X3) one input (X2, X3) direction distinction (X2, X3)
			CH3: Not set X3 as High-speed counter	Not set X3 as High-speed counter addition input (X3) subtraction input (X3)
Master input setting 2 (HSC)	401	High-speed counter settings (X4-X7)	CH4: Not set X4 as High-speed counter	Not set X4 as High-speed counter addition input (X4) subtraction input (X4) 2-phase input (X4, X5) one input (X4, X5) direction distinction (X4, X5)
			CH5: Not set X5 as High-speed counter	Not set X5 as High-speed counter addition input (X5) subtraction input (X5)
			CH6: Not set X6 as High-speed counter	Not set X6 as High-speed counter addition input (X6) subtraction input (X6) 2-phase input (X6, X7) one input (X6, X7) direction distinction (X6, X7) Reset input of the high-speed counter CH0
			CH7: Not set X7 as High-speed counter	Not set X7 as High-speed counter addition input (X7) subtraction input (X7) reset input of high-speed counter CH2

(Note 1): When the high-speed counter CH0, CH2, CH4 and CH6 are set to one of 2-phase, individual and direction distinction, the setting of CH1, CH3, CH5 and CH7 are invalid.

(Note 2): The high-speed counter hardware reset input can only use CH0 and CH2. X6 and X7 can be allocated for CH0 and CH2 respectively.

(Note 3): When the same input is set to one of high-speed counter, pulse catch and interrupt input, the priority order is high-speed counter → pulse catch → interrupt input.

Specifications

	No.	Name	Initial value	Sets value range and description
Interrupt and pulse catch setting	403	Pulse catch input setting (X0-X7)	Normal input	Normal input Input pulse X0 X1 X2 X3 X4 X5 X6 X7 Controller input <input type="checkbox"/> <input type="checkbox"/> <input type="checkbox"/> <input type="checkbox"/> <input type="checkbox"/> <input type="checkbox"/> <input type="checkbox"/> <input type="checkbox"/> The contact pressed is set as pulse catch input.
	404	Interrupt input setting (X0-X7)	Normal input	Normal input Interrupt input X0 X1 X2 X3 X4 X5 X6 X7 Controller input <input type="checkbox"/> <input type="checkbox"/> <input type="checkbox"/> <input type="checkbox"/> <input type="checkbox"/> <input type="checkbox"/> <input type="checkbox"/> <input type="checkbox"/> The contact pressed is set as pulse catch input.
Interrupt pulse edge setting	405	Interrupt edge setting (X0-X7)	Rising edge	Rising edge Falling edge rising and falling edges X0 X1 X2 X3 X4 X5 X6 X7 Rising edge <input type="checkbox"/> <input type="checkbox"/> <input type="checkbox"/> <input type="checkbox"/> <input type="checkbox"/> <input type="checkbox"/> <input type="checkbox"/> <input type="checkbox"/> X0 X1 X2 X3 X4 X5 X6 X7 Rising edge <input type="checkbox"/> <input type="checkbox"/> <input type="checkbox"/> <input type="checkbox"/> <input type="checkbox"/> <input type="checkbox"/> <input type="checkbox"/> <input type="checkbox"/> The contact pressed is set as rising edge and falling edge.

(Note 1): When the same input is set to one of high-speed counter, pulse catch and interrupt input, the priority order is high-speed counter → pulse catch → interrupt input.

No.	Name	Initial value	Sets value range and description
410 411	Unit number	1	1 - 99
412	Communication mode	Computer link	Computer link General-purpose communication PC (PLC) link MODBUS RTU
	Modem enabled	Not execute	Conduct / not conduct
413 414	Communication format	Data length: 8 bit Parity: odd Stop bit: 1 bit	Data length: 7 bit / 8 bit Parity: none / odd / even Stop bit: 1 / 2 Terminator selection: code / time End code: CR / CR+LF / none Start code: No STX / STX
415	Baud rate setting	9600 bps	2400 bps, 4800 bps, 9600 bps, 19200 bps 38400 bps, 57600 bps, 115200 bps, 230400 bps
416	(COM1) Starting address for data received of serial data communication mode	0	0 - 65532
417	(COM1) Buffer capacity setting for data received of serial data communication mode	2048	0 - 2048
418	(COM2) Starting address for data received of serial data communication mode	2048	0 - 65532
419	(COM2) Buffer capacity setting for data received of serial data communication mode	2048	0 - 2048
420	(COM0) Starting address for data received of serial data communication mode	4096	0 - 65532
421	(COM0) Buffer capacity setting for data received of serial data communication mode	2048	0 - 2048
422	(COM3) Starting address for data received of serial data communication mode	6144	0 - 65532
423	(COM3) Buffer capacity setting for data received of serial data communication mode	2048	0 - 2048
424	(COM0) Terminator judgment time (×0.01ms)	0	0-100000 or 1-10000 (0.01ms-100ms) When designated to 0, the transmission time is the time needed to transmit 4 bytes.
425	(COM1) Terminator judgment time (×0.01ms)	0	
426	(COM2) Terminator judgment time (×0.01ms)	0	
427	(COM3) Terminator judgment time (×0.01ms)	0	

COM0 \ COM1 \ COM2 \ COM3 Port setting

Specifications

(Note 1): No. 412: when you select a computer link or MODOBUS RTU in the communication mode, the No. 413 transmission format and No. 415 baud rate can be set.

(Note 2): No. 412: when selecting only the general-purpose communication in the communication mode, you can set no. 413: transmission format terminal selection, end and start codes. In addition, when selecting the terminal as time only through no. 413, you can select no. 424 to no. 427.

(Note 3): The PC (PLC) link function is only available for COM0 or COM1 port. Data length for transmission format: 8 bits,
Parity: odd, stop bit: fixed to 1. In addition, select the communication speed in PC link W0-0 system register No. 48 item.

(Note 4): The COM4 port only supports MEWTOCOL-COM communication. In addition, the communication parameters (unit number, communication format, baud rate) when the power is ON are same as the settings of the COM3 port. After RUN, you can also change the conditions by SYS1 instruction.

	No.	Name	Initial value	Sets value range and description
Time constant setting of CPU input	430	Time constant setting of CPU 1 X0-X3	No	No 1 ms 2 ms 4 ms 8 ms 16 ms 32 ms 64 ms 128 ms 256 ms
	431	Time constant setting of CPU 1 X4-X7		

26.6 Table of Special Internal Relays

WR900 (specified in word)

Relay number	Name	Description
R9000	Self-diagnostic error flag	When an error flag self-diagnostic error occurs, it is ON. → Self-diagnostic result stored in DT90000.
R9001	Unused	
R9002	Function cassette I/O error flag	When an abnormality is detected in the I/O type function cassette, it is ON.
R9003	Function cassette error flag	When an abnormality is detected in the function cassette, it is ON.
R9004	I/O verification error flag	When an I/O verification error is detected, it is ON.
R9005	Backup battery error flag (current type)	When a battery error is detected, it turns to ON. Even if you choose not to notify battery error in the system register, it is also ON when the battery runs out.
R9006	Backup battery error flag (hold)	When a battery error is detected, it turns to ON. Even if you choose not to notify battery error in the system register, it is also ON when the battery runs out. When a battery error is detected, it is maintained after the reset. →OFF when the power is cut.
R9007	Operation error flag (hold) (ER flag)	When you start running, it is ON if an error occurs, and it is maintained during operation. →The address where an error occurred stored in DT90017. (Display the operation error occurred initially.)
R9008	Operation error flag (latest) (ER flag)	It is ON whenever an operation error occurs. →The address where an error occurred stored in DT90018. Every time a new error occurs, the content will be updated.
R9009	Carry flag (CY flag)	When the operation result overflows or underflows, or when performing the result of the shift system instruction, the flag resets.
R900A	> Flag	Execute comparison instruction, if the comparison result is large, it is ON.
R900B	= Flag	Execute comparison instruction, if the comparison result is equal, it is ON. Execute operation instruction, if the comparison result is 0, it is ON.
R900C	< Flag	Execute comparison instruction, if the comparison result is small, it is ON.
R900D	Auxiliary timer contact	Execute auxiliary timing instruction (F137 / F138), it turns to ON after a set time. If the execution condition turns to OFF, the flag is OFF.
R900E (R9130)	COM0 port communication error	When using COM0 port, if it detects a communication error, it is ON.
R900F	Constant scan error flag	When performing constant scanning, if the scan time exceeds the value of the set timer (system register No. 34), it is ON. In the system register No. 34, it also turns to ON when 0 is set.

(Note 1): The special internal relay in parentheses is also allocated the same function.

WR901 (specified in words)

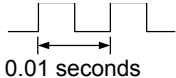
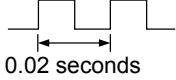
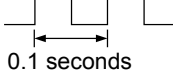
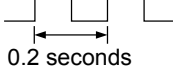
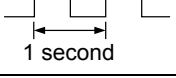
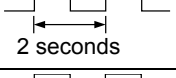
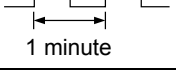
Relay number	Name	Description
R9010	Always on relay	Always on.
R9011	Always off relay	Always off.
R9012	Scan pulse relay	Turns on and off alternately at each scan.
R9013	Initial (on type) pulse relay	Goes on for only the first scan after operation (RUN) has been started, and goes off for the second and subsequent scans.
R9014	Initial (off type) pulse relay	Goes off for only the first scan after operation (RUN) has been started, and goes on for the second and subsequent scans.
R9015	Step ladder initial pulse relay (on type)	Turns on for only the first scan of a process after the boot at the step ladder control.
R9016	Not used	
R9017	Not used	
R9018	0.01 s clock pulse relay	Repeats on/off operations in 0.01 sec. cycles. 
R9019	0.02 s clock pulse relay	Repeats on/off operations in 0.02 s. cycles. 
R901A	0.1 s clock pulse relay	Repeats on/off operations in 0.1 s. cycles. 
R901B	0.2 s clock pulse relay	Repeats on/off operations in 0.2 s. cycles. 
R901C	1 s clock pulse relay	Repeats on/off operations in 1 s. cycles. 
R901D	2 s clock pulse relay	Repeats on/off operations in 2 s. cycles. 
R901E	1 min clock pulse relay	Repeats on/off operations in 1 min. cycles. 
R901F	Not used	

WR902 (specified in word)

Relay number	Name	Description
R9020	RUN mode flag	Turns off while the mode selector is set to PROG. Turns on while the mode selector is set to RUN.
R9021	Not used	
R9022	Not used	
R9023	Not used	
R9024	Not used	
R9025	Not used	
R9026	Message flag	Turns on while the F149 (MSG) instruction is executed.
R9027	Not used	
R9028	Not used	
R9029	Forcing flag	Turns on during forced on/off operation for input/output relay timer/counter contacts.
R902A	Interrupt enable flag	Turns on while the external interrupt trigger is enabled by the ICTL instruction.
R902B	Interrupt error flag	Turns on when an interrupt error occurs.
R902C	Sample point flag	Sampling by the instruction=0 Sampling at constant time intervals=1
R902D	Sample trace end flag	When the sampling operation stops=1, When the sampling operation starts=0
R902E	Sampling stop trigger flag	When the sampling stop trigger activates=1 When the sampling stop trigger stops=0
R902F	Sampling enable flag	When sampling starts=1 When sampling stops=0

WR903 (specified in word)

Relay number	Name	Description
R9030	Unused	
R9031	Unused	
R9032 (R9139)	COM1 port operation mode flag	When using the general communication function, it is ON. When using a function outside of the general communication function, it is OFF.
R9033	Print instruction executing flag	OFF: not executed. ON: executing
R9034	Program editing flag in RUN mode	The special internal relay that is ON only at the first scan cycle after program editing completed in RUN mode.
R9035	Unused	
R9036	Unused	
R9037 (R9138)	COM1 port communication error flag	When performing data communication, if a transmission error occurs, it is ON. When requesting for sending via the F159 (MTRN) instruction, it is OFF.
R9038 (R913A)	Reception completion flag for COM1 port general-purpose communication	For general communication, if the end character is received, it is ON.
R9039 (R913B)	Sending completion flag for COM1 port general-purpose communication	For general-purpose communication, if end the transmission, it is ON. For general-purpose communication, if transmitting is required, it is OFF.
R903A	Unused	
R903B	Unused	
R903C	Unused	
R903D	Unused	
R903E (R9132)	Reception completion flag for COM0 port general-purpose communication	For general-purpose communication, if the end character is received, it is ON.
R903F (R9133)	Sending completion flag for COM0 port general-purpose communication	For general-purpose communication, if end the transmission, it is ON. For general-purpose communication, if transmitting is required, it is OFF.

(Note 1): R9030 - R903F will change even during one scanning cycle. In addition, the special internal relay in parentheses is also allocated the same function.

WR904 (specified in word)

Relay number	Name	Description
R9040 (R9131)	COM0 port operation mode flag	When using the general-purpose communication function, it is ON. When using a function outside of the general-purpose communication function, it is OFF.
R9041 (R913E)	COM1 port PC (PLC) link flag	When using the PC (PLC) link function, it is ON.
R9042 (R9141)	COM2 port operation mode flag	When using the general-purpose communication function, it is ON. When using a function outside of the general-purpose communication function, it is OFF.
R9043	Unused	
R9044 (R913C)	COM1 port SEND / RECV instruction executable flag	Indicates the instruction with respect to the F145 (SEND) or F146 (RECV) instruction of the COM1 port is executable / non-executable. OFF: non-executable (instruction executing) ON: executable
R9045 (R913D)	COM1 port SEND / RECV instruction execution completion flag	Indicates the status with respect to the F145 (SEND) or F146 (RECV) instruction of the COM1 port. OFF: normal completion ON: abnormal completion (a communication error occurs) The error code is stored to DT90124.
R9046	Unused	
R9047 (R9140)	COM2 port communication error flag	When performing data communication, if a transmission error occurs, it is ON. When requesting for sending via the F159 (MTRN) instruction, it is OFF.
R9048 (R9142)	Reception completion flag for COM2 port general-purpose communication	For general communication, if the end character is received, it is ON.
R9049 (R9143)	Sending completion flag for COM2 port general-purpose communication	For general-purpose communication, if end the transmission, it is ON. For general-purpose communication, if transmitting is required, it is OFF.
R904A (R9144)	COM2 port SEND / RECV instruction executable flag	Indicates the instruction with respect to the F145 (SEND) or F146 (RECV) instruction of the COM2 port is executable / non-executable. OFF: non-executable (instruction executing) ON: executable
R904B (R9145)	COM2 port SEND / RECV instruction execution completion flag	Indicates the status with respect to the F145 (SEND) or F146 (RECV) instruction of the COM2 port. OFF: normal completion ON: abnormal completion (a communication error occurs) The error code is stored to DT90125.
R904C- R904F	Unused	

(Note 1): R9040 - R904F will change even during a scanning cycle. In addition, the special internal relay in parentheses is also allocated the same function.

WR905 (specified in word)

Relay number	Name	Description
R9050	MEWNET-W0 PC (PLC) link transmission error flag	When using MEWNET-W0 When a transmission error sent through the PC (PLC) link, it is ON. When the setting of the PC (PLC) link area is abnormal, it is ON.
R9051- R905F	Unused	

WR906 (specified in word)

Relay number	Name	Description
R9060	MEWNET-W0 PC (PLC) link 0 transmit guarantee relay	Unit no.1 For normal communication in the PC (PLC) link mode: ON When stopping, error occurs or PC (PLC) is not linked: OFF
R9061		Unit No. 2 Unit no.2 For normal communication in the PC (PLC) link mode: ON When stopping, error occurs or PC (PLC) is not linked: OFF
R9062		Unit No. 3 Unit no.3 For normal communication in the PC (PLC) link mode: ON When stopping, error occurs or PC (PLC) is not linked: OFF
R9063		Unit No. 4 Unit no.4 For normal communication in the PC (PLC) link mode: ON When stopping, error occurs or PC (PLC) is not linked: OFF
R9064		Unit No. 5 Unit no.5 For normal communication in the PC (PLC) link mode: ON When stopping, error occurs or PC (PLC) is not linked: OFF
R9065		Unit No. 6 Unit no.6 For normal communication in the PC (PLC) link mode: ON When stopping, error occurs or PC (PLC) is not linked: OFF
R9066		Unit No. 7 Unit no.7 For normal communication in the PC (PLC) link mode: ON When stopping, error occurs or PC (PLC) is not linked: OFF
R9067		Unit No. 8 Unit no.8 For normal communication in the PC (PLC) link mode: ON When stopping, error occurs or PC (PLC) is not linked: OFF
R9068		Unit No. 9 Unit no.9 For normal communication in the PC (PLC) link mode: ON When stopping, error occurs or PC (PLC) is not linked: OFF
R9069		Unit No. 10 Unit no.10 For normal communication in the PC (PLC) link mode: ON When stopping, error occurs or PC (PLC) is not linked: OFF
R906A		Unit No. 11 Unit no.11 For normal communication in the PC (PLC) link mode: ON When stopping, error occurs or PC (PLC) is not linked: OFF
R906B		Unit No. 12 Unit no.12 For normal communication in the PC (PLC) link mode: ON When stopping, error occurs or PC (PLC) is not linked: OFF
R906C		Unit No. 13 Unit no.13 For normal communication in the PC (PLC) link mode: ON When stopping, error occurs or PC (PLC) is not linked: OFF
R906D		Unit No. 14 Unit no.14 For normal communication in the PC (PLC) link mode: ON When stopping, error occurs or PC (PLC) is not linked: OFF
R906E		Unit No. 15 Unit no.15 For normal communication in the PC (PLC) link mode: ON When stopping, error occurs or PC (PLC) is not linked: OFF
R906F		Unit No. 16 Unit no.16 For normal communication in the PC (PLC) link mode: ON When stopping, error occurs or PC (PLC) is not linked: OFF

WR907 (specified in word)

Relay number	Name	Description
R9070	MEWNET-W0 PC (PLC) link 0 operation mode relay	Unit no. 1 When the unit no. 1 is in RUN mode: ON. When in PROG mode: OFF.
R9071		Unit no. 2 When the unit no. 2 is in RUN mode: ON. When in PROG mode: OFF.
R9072		Unit no. 3 When the unit no. 3 is in RUN mode: ON. When in PROG mode: OFF.
R9073		Unit no. 4 When the unit no. 4 is in RUN mode: ON. When in PROG mode: OFF.
R9074		Unit no. 5 When the unit no. 5 is in RUN mode: ON. When in PROG mode: OFF.
R9075		Unit no. 6 When the unit no. 6 is in RUN mode: ON. When in PROG mode: OFF.
R9076		Unit no. 7 When the unit no. 7 is in RUN mode: ON. When in PROG mode: OFF.
R9077		Unit no. 8 When the unit no. 8 is in RUN mode: ON. When in PROG mode: OFF.
R9078		Unit no. 9 When the unit no. 9 is in RUN mode: ON. When in PROG mode: OFF.
R9079		Unit no. 10 When the unit no. 10 is in RUN mode: ON. When in PROG mode: OFF.
R907A		Unit no. 11 When the unit no. 11 is in RUN mode: ON. When in PROG mode: OFF.
R907B		Unit no. 12 When the unit no. 12 is in RUN mode: ON. When in PROG mode: OFF.
R907C		Unit no. 13 When the unit no. 13 is in RUN mode: ON. When in PROG mode: OFF.
R907D		Unit no. 14 When the unit no. 14 is in RUN mode: ON. When in PROG mode: OFF.
R907E		Unit no. 15 When the unit no. 15 is in RUN mode: ON. When in PROG mode: OFF.
R907F		Unit no. 16 When the unit no. 16 is in RUN mode: ON. When in PROG mode: OFF.

WR908 (specified in word)

Relay number	Name	Description
R9080	MEWNET-W0 PC (PLC) link 1 transmit guarantee relay	Unit no.1 For normal communication in the PC (PLC) link mode: ON When stopping, error occurs or PC (PLC) is not linked: OFF
R9081		Unit no.2 For normal communication in the PC (PLC) link mode: ON When stopping, error occurs or PC (PLC) is not linked: OFF
R9082		Unit no.3 For normal communication in the PC (PLC) link mode: ON When stopping, error occurs or PC (PLC) is not linked: OFF
R9083		Unit no.4 For normal communication in the PC (PLC) link mode: ON When stopping, error occurs or PC (PLC) is not linked: OFF
R9084		Unit no.5 For normal communication in the PC (PLC) link mode: ON When stopping, error occurs or PC (PLC) is not linked: OFF
R9085		Unit no.6 For normal communication in the PC (PLC) link mode: ON When stopping, error occurs or PC (PLC) is not linked: OFF
R9086		Unit no.7 For normal communication in the PC (PLC) link mode: ON When stopping, error occurs or PC (PLC) is not linked: OFF
R9087		Unit no.8 For normal communication in the PC (PLC) link mode: ON When stopping, error occurs or PC (PLC) is not linked: OFF
R9088		Unit no.9 For normal communication in the PC (PLC) link mode: ON When stopping, error occurs or PC (PLC) is not linked: OFF
R9089		Unit no.10 For normal communication in the PC (PLC) link mode: ON When stopping, error occurs or PC (PLC) is not linked: OFF
R908A		Unit no.11 For normal communication in the PC (PLC) link mode: ON When stopping, error occurs or PC (PLC) is not linked: OFF
R908B		Unit no.12 For normal communication in the PC (PLC) link mode: ON When stopping, error occurs or PC (PLC) is not linked: OFF
R908C		Unit no.13 For normal communication in the PC (PLC) link mode: ON When stopping, error occurs or PC (PLC) is not linked: OFF
R908D		Unit no.14 For normal communication in the PC (PLC) link mode: ON When stopping, error occurs or PC (PLC) is not linked: OFF
R908E		Unit no.15 For normal communication in the PC (PLC) link mode: ON When stopping, error occurs or PC (PLC) is not linked: OFF
R908F		Unit no.16 For normal communication in the PC (PLC) link mode: ON When stopping, error occurs or PC (PLC) is not linked: OFF

WR909 (specified in word)

Relay number	Name	Description
R9090	MEWNET-W0 PC (PLC) link 1 operation mode relay	Unit no. 1 When the unit no. 1 is in RUN mode: ON. When in PROG mode: OFF.
R9091		Unit no. 2 When the unit no. 2 is in RUN mode: ON. When in PROG mode: OFF.
R9092		Unit no. 3 When the unit no. 3 is in RUN mode: ON. When in PROG mode: OFF.
R9093		Unit no. 4 When the unit no. 4 is in RUN mode: ON. When in PROG mode: OFF.
R9094		Unit no. 5 When the unit no. 5 is in RUN mode: ON. When in PROG mode: OFF.
R9095		Unit no. 6 When the unit no. 6 is in RUN mode: ON. When in PROG mode: OFF.
R9096		Unit no. 7 When the unit no. 7 is in RUN mode: ON. When in PROG mode: OFF.
R9097		Unit no. 8 When the unit no. 8 is in RUN mode: ON. When in PROG mode: OFF.
R9098		Unit no. 9 When the unit no. 9 is in RUN mode: ON. When in PROG mode: OFF.
R9099		Unit no. 10 When the unit no. 10 is in RUN mode: ON. When in PROG mode: OFF.
R909A		Unit no. 11 When the unit no. 11 is in RUN mode: ON. When in PROG mode: OFF.
R909B		Unit no. 12 When the unit no. 12 is in RUN mode: ON. When in PROG mode: OFF.
R909C		Unit no. 13 When the unit no. 13 is in RUN mode: ON. When in PROG mode: OFF.
R909D		Unit no. 14 When the unit no. 14 is in RUN mode: ON. When in PROG mode: OFF.
R909E		Unit no. 15 When the unit no. 15 is in RUN mode: ON. When in PROG mode: OFF.
R909F		Unit no. 16 When the unit no. 16 is in RUN mode: ON. When in PROG mode: OFF.

WR910 - WR912 (specified in word)

Relay number	Name		Description
R9100-R910F	Unused		
R9110	High-speed counter control flag	HSC-CH0	When using high-speed counter function, it is ON during the execution of F166 (HC1S) and F167 (HC1R) instructions. It is OFF when the action is completed.
R9111		HSC-CH1	
R9112		HSC-CH2	
R9113		HSC-CH3	
R9114		HSC-CH4	
R9115		HSC-CH5	
R9116		HSC-CH6	
R9117		HSC-CH7	
R9118-R912F	Unused		

WR913 (specified in word)

Relay number	Name	Description
R9130 (R900E)	COM0 port communication error flag	When performing data communication, if a transmission error occurs, it is ON. When requesting for sending via the F159 (MTRN) instruction, it is OFF.
R9131 (R9040)	COM0 port operation mode flag	When using the general-purpose communication function, it is ON. When using a function outside of the general-purpose communication function, it is OFF.
R9132 (R903E)	Reception completion flag for COM0 port general-purpose communication	For general-purpose communication, if the end character is received, it is ON.
R9133 (R903F)	Sending completion flag for COM0 port general-purpose communication	For general-purpose communication, if end the transmission, it is ON. For general-purpose communication, if transmitting is required, it is OFF.
R9134	COM port SEND / RECV instruction executable flag	Indicates the status with respect to the Executable/Non-executable status of F145 (SEND) or F146 (RECV) instruction of the COM0 port. OFF: non-executable (instruction executing) ON: executable
R9135	COM0 port SEND / RECV instruction execution completion flag	Indicates the status with respect to the execution status of F145 (SEND) or F146 (RECV) instruction of the COM0 port. OFF: normal completion ON: abnormal completion (a communication error occurs) The error code is stored to DT90123.
R9136	COM0 port PC (PLC) link flag	When using the PC (PLC) link function, it is ON.
R9137	Unused	
R9138 (R9037)	COM1 port communication error flag	When performing data communication, if a transmission error occurs, it is ON. When executing via F159 (MTRN) instruction, if transmitting is required, it is OFF.
R9139 (R9032)	COM1 port operation mode flag	When using the general-purpose communication function, it is ON. When using a function outside of the general-purpose communication function, it is OFF.
R913A (R9038)	Reception completion flag for COM1 port general communication	For general-purpose communication, if the end character is received, it is ON.
R913B (R9039)	Sending completion flag for COM1 port general communication	For general-purpose communication, if end the transmission, it is ON. For general-purpose communication, if transmitting is required, it is OFF.
R913C (R9044)	COM1 port SEND / RECV instruction executable flag	Indicates the status with respect to the Executable/Non-executable status of F145 (SEND) or F146 (RECV) instruction of the COM0 port. OFF: non-executable (instruction executing) ON: executable
R913D (R9045)	COM1 port SEND / RECV instruction execution completion flag	Indicates the status with respect to the execution status of F145 (SEND) or F146 (RECV) instruction of the COM1 port. OFF: normal completion ON: abnormal completion (a communication error occurs) The error code is stored to DT90124.
R913E (R9041)	COM1 port PC (PLC) link flag	When using the PC (PLC) link function, it is ON.
R913F	Unused	

(Note 1): R9130 - R913F will change even during one scanning cycle. In addition, it is compatible with the older model FP-X control unit, the special internal relay in parentheses also can be allocated the same function.

WR914 (specified in word)

Relay number	Name	Description
R9140 (R9047)	COM2 port communication error flag	When performing data communication, if a transmission error occurs, it is ON. When executing via F159 (MTRN) instruction, if transmitting is required, it is OFF.
R9141 (R9042)	COM2 port operation mode flag	When using the general-purpose communication function, it is ON. When using a function outside of the general-purpose communication function, it is OFF.
R9142 (R9048)	Reception completion flag for COM2 port general-purpose communication	For general-purpose communication, if the end character is received, it is ON.
R9143 (R9049)	Sending completion flag for COM2 port general-purpose communication	For general-purpose communication, if end the transmission, it is ON. For general-purpose communication, if transmitting is required, it is OFF.
R9144 (R904A)	COM2 port SEND / RECV instruction executable flag	Indicates the status with respect to the Executable/Non-executable status of F145 (SEND) or F146 (RECV) instruction of the COM0 port. OFF: non-executable (instruction executing) ON: executable
R9145 (R904B)	COM2 port SEND / RECV instruction execution completion flag	Indicates the status with respect to the execution status of F145 (SEND) or F146 (RECV) instruction of the COM2 port. OFF: normal completion ON: abnormal completion (a communication error occurs) The error code is stored to DT90125.
R9146	Unused	
R9147	Unused	
R9148	COM3 port communication error flag	When performing data communication, if a transmission error occurs, it is ON. When executing via F159 (MTRN) instruction, if transmitting is required, it is OFF.
R9149	COM3 port operation mode flag	When using the general-purpose communication function, it is ON. When using a function outside of the general-purpose communication function, it is OFF.
R914A	Reception completion flag for COM3 port general communication	For general communication, if the end character is received, it is ON.
R914B	Sending completion flag for COM3 port general-purpose communication	For general-purpose communication, if end the transmission, it is ON. For general-purpose communication, if transmitting is required, it is OFF.
R914C	COM3 port SEND / RECV instruction executable flag	Indicates the status with respect to the Executable/Non-executable status of F145 (SEND) or F146 (RECV) instruction of the COM0 port. OFF: non-executable (instruction executing) ON: executable
R914D	COM3 port SEND / RECV instruction execution completion flag	Indicates the status with respect to the execution status of F145 (SEND) or F146 (RECV) instruction of the COM3 port. OFF: normal completion ON: abnormal completion (a communication error occurs) The error code is stored to DT90127.
R914E	Unused	
R914F	Unused	

(Note 1): R9140 - R914F will change even during a scanning cycle. In addition, it is compatible with the older model FP-X control unit, the special internal relay in parentheses also can be allocated the same function.

WR915 (specified in word)

Relay number	Name	Description
R9150	COM4 port communication error flag	When performing data communication, if a transmission error occurs, it is ON. When requesting for sending via the F159 (MTRN) instruction, it is OFF.
R9151	COM4 port operation mode flag	When using the general-purpose communication function, it is ON. When using a function outside of the general-purpose communication function, it is OFF.
R9152	Reception completion flag for COM4 port general-purpose communication	For general-purpose communication, if the end character is received, it is ON.
R9153	Sending completion flag for COM4 port general-purpose communication	For general-purpose communication, if end the transmission, it is ON. For general-purpose communication, if transmitting is required, it is OFF.
R9154	COM4 port SEND / RECV instruction executable flag	Indicates the status with respect to the Executable/Non-executable status of F145 (SEND) or F146 (RECV) instruction of the COM0 port. OFF: non-executable (instruction executing) ON: executable
R9155	COM4 port SEND / RECV instruction execution completion flag	Indicates the status with respect to the execution status of F145 (SEND) or F146 (RECV) instruction of the COM4 port. OFF: normal completion ON: abnormal completion (a communication error occurs) The error code is stored to DT90128.
R9156 -R915F	Unused	

26.7 Table of Special Data Registers

Register Number	Name	Description	R	W
DT90000	Self-diagnostic error code	When a self-diagnostic error occurs, the error code is stored.	○	×
DT90001	Unused		×	×
DT90002	Function cassette I/O error occurring location	When an error occurs in the function cassette, the corresponding bit is ON. 15 11 7 3 2 1 0 (Bit No.) 2 1 (Expansion No.) ON(1): Abnormal OFF(0): Normal	○	×
DT90003 -DT90005	Unused		×	×
DT90006	Function cassette error occurring location	When an error occurs in the function cassette, the corresponding bit is ON. 15 11 7 3 2 1 0 (Bit No.) 2 1 (Expansion No.) ON(1): Abnormal OFF(0): Normal	○	×
DT90007	System register error number	When there is mismatch in the setting content of the system register, save the object system register number.	○	×
DT90008	Communication error flag COM4 port	Save error contents when using the COM4 port. ON (1): Error, OFF (0): Normal bit no. 15 8 7 0 H00 Fixed COM4 Overflow error COM4 Parity error COM4 Framing error COM4 Ultra-limit running error	○	×
DT90009	Communication error flag COM2 port / COM3 port	Save error contents when using the COM2 / COM3 port. ON (1): Error, OFF (0): Normal bit no. 15 8 7 0 COM3 Overflow error COM3 Parity error COM3 Framing error COM3 Ultra-limit running error COM2 Overflow error COM2 Parity error COM2 Framing error COM2 Ultra-limit running error	○	×
DT90010	FP-X Expansion I/O Unit verify mismatched unit position	When the FP-X expansion I/O unit installation state turns to power ON, the corresponding bit to the unit number is ON (1). Monitor with BIN display. 15 11 7 6 5 4 3 2 1 0 (Bit No.) 7 6 5 4 3 2 1 0 (Expansion No.) ON(1): Abnormal OFF(0): Normal	○	×

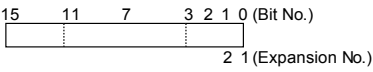
Register Number	Name	Description	R	W
DT90011	Add-on cassette verify mismatched unit position	When the FP-X add-on cassette installation state turns to power ON, the corresponding bit to the add-on cassette number is ON (1). Monitor with BIN display.  ON(1): Abnormal OFF(0): Normal	○	×
DT90012 -DT90013	Unused		×	×
DT90014	Operation auxiliary register of the data shift instruction	After executing the data shift instruction F105 (BSR) or F106 (BSL), the 1 digit data removed out is saved to the bit 0 - 3. Execute F0 (MV) instruction, values can be read and write.	○	○
DT90015	Operation auxiliary register of the division instruction	When executing 16-bit division instruction F32 (%), F52 (B%), the 16 bit of the remainder is saved to DT90015.	○	○
DT90016		When executing 32-bit division instruction F33 (D%), F53 (DB%), the 32 bit of the remainder is saved to DT90015-DT90016. Execute F1 (DMV) instruction, values can be read and write.		
DT90017	Operation error address (hold)	After running, the address occurs an operation error first is stored. Please use decimalism display to perform monitoring.	○	×
DT90018	Operation error address (latest)	The address where an error occurred is stored. Update when each time an error occurs. Please use decimalism display to perform monitoring.	○	×
DT90019	2.5 ms RING counter ^(Note 2)	The stored value is increased by 1 every 2.5 ms. (H0-HFFFF) The difference between 2 points (absolute value) × 2.5 ms = elapsed time between 2 points	○	×
DT90020	10 μs RING counter ^(note 2, 3)	Saved value +1 every 10.00 μs. (H0-HFFFF) The difference between 2 points (absolute value) × 10.00 μs = (elapsed time between 2 points) note) the correct value is 10.00 μs.	○	×
DT90021	Unused		×	×
DT90022	Scanning time (current value) ^(note 1)	The current value of the scanning time is saved. [Saved value (decimal)] × 0.1 ms (Example) For K50, it indicates within 5 ms.	○	×
DT90023	Scanning time (min) ^(note 1)	The minimum value of the scanning time is saved. [Saved value (decimal)] × 0.1 ms (Example) For K50, it indicates within 5 ms.	○	×
DT90024	Scanning time (max) ^(note 1)	The maximum value of the scanning time is saved. [Saved value (decimal)] × 0.1 ms (Example) For K125, it indicates within 12.5 ms.	○	×

(Note 1): The scanning time and operation cycle time only display in RUN mode. The scanning time of the operation is not displayed in PROG. mode. When the maximum and minimum value are shifted between RUN mode and PROG. mode, they are temporarily cleared.

(Note 2): During one scan, it is updated once at the beginning.

(Note 3): DT90020 is also updated when executing F0 (MV), therefore, it can be used to measure the time interval.

Register Number	Name	Description	R	W
DT90025	Interrupt enable (mask) state (INT0 - 7)	<p>The content set by the ICTL instruction is saved. Monitor with BIN display.</p> <p>INT0 - INT7: interrupt input X0 - X7 INT0 - INT7: high-speed counter match interrupt CH0 - CH7</p>	○	×
DT90026	Unused		×	×
DT90027	Timer interrupt interval (INT24)	<p>The content set by the ICTL instruction is saved. K0: do not use the timer interrupt. K1-K3000: 0.1 ms-0.35 s or 0.5 ms-1.5 s or 10 ms-30 s</p>	○	×
DT90028	Sampling and tracking interval	<p>K0: changed to sampling performed according to the SMPL instruction. K1 - K3000 (× 10ms): 10 ms - 30 s</p>	○	×
DT90029	Unused		×	×
DT90030	Character storage by F149 MSG instruction	Stores contents set through the information display instruction (F149) (character).	○	×
DT90031				
DT90032				
DT90033				
DT90034				
DT90035				
DT90036	Status error occurrence position of FP-X expansion unit/add-on cassette	<p>Stores the corresponding number upon abnormal status. High byte: FP-X expansion unit Low byte: add-on cassette (E.g.) The cassette installation part 2 is abnormal for 0001h.</p>	○	×
DT90037	Work 1 for search instruction	When executing F96 (SRC) instruction, the number that is consistent with the search data is saved.	○	×
DT90038	Work 2 for search instruction	When executing F96 (SRC) instruction, a consistent relative position is saved.	○	×
DT90039	Unused		×	×
DT90040	Potentiometer input	Stores potentiometer value (K0 - K4000). Read to the data register by the user program, and it can be used in the analog timer.	○	×
DT90041 -DT90043	Unused		×	×
DT90044	System job	Used in the system.	○	×
DT90045 -DT90051	Unused		×	×

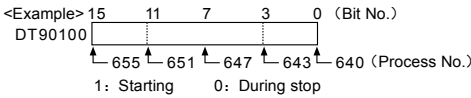
Register Number	Name	Description	R	W
DT90086	Step ladder process (416-431)	<p>It indicates the starting status of the step ladder diagram program process. When the process starts, the bit corresponding to its process number is ON.</p> <p>Monitor with BIN display.</p> <p><Example>  (Bit No.) DT90100 655 651 647 643 640 (Process No.) 1: Starting 0: During stop</p> <p>The data can be written using a programming tool.</p>	○	○
DT90087	Step ladder process (432-447)			
DT90088	Step ladder process (448-463)			
DT90089	Step ladder process (464-479)			
DT90090	Step ladder process (480-495)			
DT90091	Step ladder process (496-511)			
DT90092	Step ladder process (512-527)			
DT90093	Step ladder process (528-543)			
DT90094	Step ladder process (544-559)			
DT90095	Step ladder process (560-575)			
DT90096	Step ladder process (576-591)			
DT90097	Step ladder process (592-607)			
DT90098	Step ladder process (608-623)			
DT90099	Step ladder process (624-639)			
DT90100	Step ladder process (640-655)			
DT90101	Step ladder process (656-671)			
DT90102	Step ladder process (672-687)			
DT90103	Step ladder process (688-703)			
DT90104	Step ladder process (704-719)			
DT90105	Step ladder process (720-735)			
DT90106	Step ladder process (736-751)			
DT90107	Step ladder process (752-767)			
DT90108	Step ladder process (768-783)			
DT90109	Step ladder process (784-799)			
DT90110	Step ladder process (800-815)			
DT90111	Step ladder process (816-831)			
DT90112	Step ladder process (832-847)			
DT90113	Step ladder process (848-863)			
DT90114	Step ladder process (864-879)			
DT90115	Step ladder process (880-895)			
DT90116	Step ladder process (896-911)			
DT90117	Step ladder process (912-927)			
DT90118	Step ladder process (928-943)			
DT90119	Step ladder process (944-959)			
DT90120	Step ladder process (960-975)			
DT90121	Step ladder process (976-991)			
DT90122	Step ladder process (992-999) (High byte not used)			

Register Number	Name	Description	R	W
DT90123	COM0 SEND / RECV end code	If an error occurs when executing SEND / RECV instruction, the error code is saved.	○	×
DT90124	COM1 SEND / RECV end code		○	×
DT90125	COM2 SEND / RECV end code		○	×
DT90126	Force I/O active unit No.	Used in the system.	○	×
DT90127	COM3 SEND / RECV end code	If an error occurs when executing SEND / RECV instruction, the error code is saved.	○	×
DT90127	COM4 SEND / RECV end code		○	×
DT90128- DT90139	Unused		×	×

Specifications

Register Number	Name	Description	R	W
DT90140	MEWNET-W0 PC (PLC) link 0 status	PC (PLC) link0 number of times of reception	○	×
DT90141		PC(PLC) link 0 reception interval (current value) (x2.5ms)		
DT90142		PC(PLC) link 0 reception interval (minimum value) (x2.5ms)		
DT90143		PC(PLC) link 0 reception interval (maximum value) (x2.5ms)		
DT90144		PC (PLC) link0 number of times of transmission		
DT90145		PC (PLC) link0 transmission interval (current value) (x 2.5ms)		
DT90146		PC (PLC) link0 transmission interval (minimum value) (x 2.5ms)		
DT90147		PC (PLC) link0 transmission interval (maximum value) (x 2.5ms)		
DT90148	MEWNET-W0 PC (PLC) link 1 status	PC (PLC) link0 number of times of reception	○	×
DT90149		PC(PLC) link 0 reception interval (current value) (x2.5ms)		
DT90150		PC(PLC) link 0 reception interval (minimum value) (x2.5ms)		
DT90151		PC(PLC) link 0 reception interval (maximum value) (x2.5ms)		
DT90152		PC (PLC) link0 number of times of transmission		
DT90153		PC (PLC) link0 transmission interval (current value) (x 2.5ms)		
DT90154		PC (PLC) link0 transmission interval (minimum value) (x 2.5ms)		
DT90155		PC (PLC) link0 transmission interval (maximum value) (x 2.5ms)		
DT90156	MEWNET-W0 PC (PLC) link 0 status	PC (PLC) link0 work for measuring reception interval	○	×
DT90157		PC (PLC) link0 work for measuring transmission interval		
DT90158	MEWNET-W0 PC (PLC) link 1 status	PC (PLC) link1 work for measuring reception interval	○	×
DT90159		PC (PLC) link1 work for measuring transmission interval		
DT90160	MEWNET-W0 PC (PLC) link 0 unit no.	The PC (PLC) link 0 unit no. is saved.	○	×
DT90161	MEWNET-W0 PC (PLC) link 0 error flag	The error content of PC (PLC) link 0 is saved.	○	×
DT90162- DT90169	Unused		×	×
DT90170	MEWNET-W0 PC (PLC) link 0 status	PC(PLC) link address duplicate destination	○	×
DT90171		No. of missing tokens		
DT90172		No. of duplicate tokens		
DT90173		No. of no signal states		
DT90174		No. of times of receptions of undefined commands		
DT90175		No. of sum check errors for reception		
DT90176		No. of received data format error		
DT90177		No. of transmission errors		
DT90178		No. of procedure errors		
DT90179		No. of duplicate master units		
DT90180 -DT90218	Unused		×	×

Register Number	Name		Description	R	W			
DT90219	Unit number switch of DT90220 - DT90251		0: Unit number 1-8, 1: Unit number 9-16	○	×			
DT90220	PC (PLC) link unit no. 1 or 9	System registers 40 and 41	<p>The Settings of the system register related to each unit number PC (PLC) link function are saved as following.</p> <p><Example > When the DT90219 is 0</p> <p>(Station number 1)</p> <p>Set content of system registers 40, 42, 44, 46</p> <p>Set content of system registers 41, 43, 45, 47</p>	○	×			
DT90221		System registers 42 and 43						
DT90222		System registers 44 and 45						
DT90223		System registers 46 and 47						
DT90224	PC (PLC) link unit no. 2 or 10	System registers 40 and 41						
DT90225		System registers 42 and 43						
DT90226		System registers 44 and 45						
DT90227		System registers 46 and 47						
DT90228	PC (PLC) link unit no. 3 or 11	System registers 40 and 41				<p>If the master unit system register 46 is standard setting, 46 and 47 on the left will copy the value of the master unit. If the master unit system register 46 is set reversely, it indicates the left master unit part 40-45 and 47 are set to 50-55 and 57, 46 remain unchanged. In addition, it indicates the other unit part 40-45 are set to values after correcting the received values, while 46 and 47 are set to 46 and 57 of the master unit.</p>	○	×
DT90229		System registers 42 and 43						
DT90230		System registers 44 and 45						
DT90231		System registers 46 and 47						
DT90232	PC (PLC) link unit no. 4 or 12	System registers 40 and 41						
DT90233		System registers 42 and 43						
DT90234		System registers 44 and 45						
DT90235		System registers 46 and 47						

Register Number	Name		Description	R	W						
DT90236	PC (PLC) link unit no. 5 or 13	System registers 40 and 41	<p>The Settings of the system register related to each unit number PC (PLC) link function are saved as following.</p> <p>< Example > When the DT90219 is 0</p> <p>DT90220~DT90223 (Station number 1)</p> <p>High byte Low byte</p> <p>Set content of system registers 40, 42, 44, 46</p> <p>Set content of system registers 41, 43, 45, 47</p>	○	×						
DT90237		System registers 42 and 43									
DT90238		System registers 44 and 45									
DT90239		System registers 46 and 47									
DT90240	PC (PLC) link unit no.6 or 14	System registers 40 and 41									
DT90241		System registers 42 and 43									
DT90242		System registers 44 and 45									
DT90243		System registers 46 and 47									
DT90244	PC (PLC) link unit no. 7 or 15	System registers 40 and 41				<p>If the master unit system register 46 is standard setting, 46 and 47 on the left will copy the value of the master unit.</p> <p>If the master unit system register 46 is set reversely, it indicates the left master unit part 40-45 and 47 are set to 50-55 and 57, 46 remain unchanged.</p> <p>In addition, it indicates the other unit part 40-45 are set to values after correcting the received values, while 46 and 47 are set to 46 and 57 of the master unit.</p>	○	×			
DT90245		System registers 42 and 43									
DT90246		System registers 44 and 45									
DT90247		System registers 46 and 47									
DT90248	PC (PLC) link unit no. 8 or 16	System registers 40 and 41									
DT90249		System registers 42 and 43									
DT90250		System registers 44 and 45									
DT90251		System registers 46 and 47									
DT90252 -DT90299	Unused									×	×

Register Number	Name		Description	R	W	
DT90300	Elapsed value area	Low word	HSC-CH0	The counting area of the high-speed counter controller input CH0 (X0) or (X0, X1).	○	○
DT90301		High word				
DT90302	Target value area	Low word				
DT90303		High word				
DT90304	Elapsed value area	Low word	HSC-CH1	The counting area of the high-speed counter controller input (X1).	○	○
DT90305		High word				
DT90306	Target value area	Low word				
DT90307		High word				
DT90308	Elapsed value area	Low word	HSC-CH2	The counting area of the high-speed counter controller input (X2) or (X2, X3).	○	○
DT90309		High word				
DT90310	Target value area	Low word				
DT90311		High word				
DT90312	Elapsed value area	Low word	HSC-CH3	The counting area of the high-speed counter controller input (X3).	○	○
DT90313		High word				
DT90314	Target value area	Low word				
DT90315		High word				
DT90316	Elapsed value area	Low word	HSC-CH4	The counting area of the high-speed counter controller input (X4) or (X4, X5).	○	○
DT90317		High word				
DT90318	Target value area	Low word				
DT90319		High word				
DT90320	Elapsed value area	Low word	HSC-CH5	The counting area of the high-speed counter controller input (X5).	○	○
DT90321		High word				
DT90322	Target value area	Low word				
DT90323		High word				
DT90324	Elapsed value area	Low word	HSC-CH6	The counting area of the high-speed counter controller input (X6) or (X6, X7).	○	○
DT90325		High word				
DT90326	Target value area	Low word				
DT90327		High word				
DT90328	Elapsed value area	Low word	HSC-CH7	The counting area of the high-speed counter controller input (X7).	○	○
DT90329		High word				
DT90330	Target value area	Low word				
DT90331		High word				
DT90332 -DT90379	Unused				×	×

(Note 1): Only F1 (DMV) instruction can perform the reading and writing of elapsed value area.

(Note 2): When executing the high-speed counter target value consistent instruction F166 (HC1S) or F167 (HC1R) instruction, the target value area is set. It can not be written by the user program.

26.8 Table of Error Codes

26.8.1 Table of Syntax Check Errors

Error Codes 1-8

Code	Name	Run	Error content and handling method
E1	Syntax error	Stop	<ul style="list-style-type: none"> ● A sequencer with syntax errors has been written in. ● Switch to PROG. mode and correct the error.
E2	Duplicate Use (Definition) Error (note 1)	Stop	<ul style="list-style-type: none"> ● The same relay was used repeatedly in the output instruction and hold instruction. It also happens when using the same timer / counter number. ● Please switch to PROG. mode and modify the program to ensure that 1 relay is only outputted once in 1 program. Or, select to allow dual output by the system register No. 20. However, even in the choice of running dual output, a timer / counter instruction reuse definition error is still detected.
E3	Not paired error	Stop	<ul style="list-style-type: none"> ● Executing of the instruction used by matching (JP and LBL etc.) is not possible due to one is missing or there is a wrong positioning relation. ● Please switch to PROG. mode and enter the 2 instructions for matching into the correct position.
E4	Parameter mismatch error	Stop	<ul style="list-style-type: none"> ● An instruction word inconsistent with the system register settings was written in. The range setting of the timer / counter is inconsistent with the number assignment in the program. ● Switch to PROG. mode to confirm the contents of the system register, and reconcile the setting and instruction word.
E5	Program area error (note 1)	Stop	<ul style="list-style-type: none"> ● The instruction to determine executable area (main program area, deputy program area) is written into a position outside of the area (the subroutine SUB - RET etc. were recorded before the ED instruction). ● Switch to PROG. mode, and enter the instruction into the specified area.
E6	Compile memory full	Stop	<ul style="list-style-type: none"> ● Unable to compile all programs. ● Switch to PROG. mode to reduce the total number of steps of the program.
E7	High-level instruction type error	Stop	<ul style="list-style-type: none"> ● The executing for each scan type and differential execution type are mixed in multiple application instructions that perform continuous writing. ● Concentrate the executing for each scan type and differential execution type and add individual execution condition.
E8	High-level instruction operand combination error	Stop	<ul style="list-style-type: none"> ● The combination instruction is determined by multiple operands (unify types etc.), and the combination is wrong. ● Please log in to the operands with the correct combination.

(Note 1): The E2 and E5 error codes mean errors than can be detected even it is required to correct a syntax in the RUN mode. In this case, the control unit does not write anything and continues to run.

26.8.2 Table of Self-diagnostic Errors

Code	Name	Run	Error content and handling method
E20	Watchdog timer timeout	Stop	<ul style="list-style-type: none"> ● The watchdog timer is started, but the running stops. A hardware error or operation stagnation has occurred. ● Please check if there is a infinite loop in the control instructions (JP, LOOP, etc.) used to change the program handling process. If the program itself is OK, it may be due to a hardware error.
E21	Motion part startup error	Stop	<ul style="list-style-type: none"> ● It may be due to a hardware error. Please contact our company.
E22	Hardware error	Stop	<ul style="list-style-type: none"> ● It may be due to a hardware error. Please contact our company.
E25	Inconsistent master memory models	Stop	<ul style="list-style-type: none"> ● The master memory models are inconsistent. Use a master memory created by the same model.
E26	User ROM error	Stop	<ul style="list-style-type: none"> ● When installing the master memory cassette, the master memory may be corrupted. ● Remove the master memory cassette to check for errors. If there is no error, the contents of the master memory may be corrupted. ● Use it after rewriting the master memory. If the error cannot be cleared, please contact our company.
E27	Unit installation is restricted.	Stop	<ul style="list-style-type: none"> ● The unit installation number exceeds the limits. ● Please turn off the power to confirm whether the combination unit is within the limit range.
E29	Configuration parameter error	Stop	<ul style="list-style-type: none"> ● It may be due to a hardware error. Please contact our company.
E34	Abnormal I/O status	Stop	<ul style="list-style-type: none"> ● An abnormal unit is installed. ● Confirm the slot number by DT90036, replace the abnormal unit with a normal one.
E40	I/O error	Select	<ul style="list-style-type: none"> ● The function cassette may be abnormal. Confirm its location through the data register DT90002 and repair it. ● You can use the tool software to confirm it by the [I/O Error] button in the status display dialog box.
E41	Special unit collapse	Select	<ul style="list-style-type: none"> ● It may be due to abnormal high function unit. Confirm its location through the special data register DT90006 and repair it. ● You can use the tool software to confirm it by the [Special Error] button in the status display dialog box.
E42	I/O check error	Select	<ul style="list-style-type: none"> ● The connection status of the input and output unit (expansion unit) is different from that when the power is turned on. ● Verify the input and output unit whose connection status changed through the special data registers DT90010 and DT90011. Or, verify the engagement of the expansion connector. ● You can use the tool software to confirm it by the [Check Error] button in the status display dialog box.
E43	Initial error of the motion part	Select	<ul style="list-style-type: none"> ● It may be due to a hardware error. Please contact our company.

Code	Name	Run	Error content and handling method
E44	A position control operation error occurred	Select	<ul style="list-style-type: none"> ● Parameter settings may be incorrect, or there was a limit error. ● Check if the parameters are within the range that can be specified. ● Check the AMP error code for the channel on which the positioning operation error occurs and the content on the data monitor of Configurator PM7.
E45	Operation error occurred	Select	<ul style="list-style-type: none"> ● An operation error cannot be performed occurred. ● The operation error address can be confirmed by one of the special register DT90017 and DT90018. You can use the tool software to confirm it by the [Operation Error] button in the status display dialog box.
E47	Motion part AMP communication error	Select	<ul style="list-style-type: none"> ● An error in the communication with the servo amplifier occurred. ● Check the connection. ● Check the AMP error code on the data monitor of Configurator PM7.
E48	Abnormal system register setting	Stop running	<ul style="list-style-type: none"> ● The settings of the system register are abnormal. Check the settings again. Example) If the data register and internal relay ranges set by the system register No. 0 and No. 1 are not matched with the setting of the system register No. 7 and No. 8 hold / non-hold area and the setting of the system register No. 416-No. 423 universal communication buffer area, an error will occur. ● Verify the number of the system register through the special register DT90007.
E49	Abnormal expansion power sequence	Stop running	<ul style="list-style-type: none"> ● The power of the expansion Unit is turned on later than the control unit. Make sure it is powered on before the control unit or at the same time.
E50	Abnormal battery (battery fall off or voltage reduced)	continues operation	<ul style="list-style-type: none"> ● The backup battery voltage is lower than the specified voltage, or the control unit is not connected to the battery. Verify the backup battery, pay attention to the replacement and connection work. ● You can set whether to notify the self-diagnostic error through the system register No. 4.
E100- E199	Self-diagnosis error set by F148	Stop	<ul style="list-style-type: none"> ● An error set by the application instruction F148 occurred. ● Handle it according to the detection conditions set.
E200- E299		Operation continues	

26.8.3 Table of MEWTOCOL-COM Communication Errors

Code	Name	Description
! 26	Unit number setting error	An instruction can not be used in the global area (station number FF) is received.
! 40	BCC error	A transmission error occurs in the received data.
! 41	Format error	An instruction inconsistent with the format is received.
! 42	NOT support error	An unsupported instruction is received.
! 43	Multiple frames procedure error	In the multi-frame processing, another instruction is received.
! 60	Parameter error	The specified parameter content does not exist or can not be used.
! 61	Data error	There is an error in the contact, data area, data number assignment, size assignment, range and format assignment.
! 62	Registration over error	Exceeds login times or operate without logging in.
! 63	PC mode error	An instruction can not be processed was executed in RUN mode.
! 64	External memory error	Bad hardware. The built-in ROM (F-ROM) / master memory may be abnormal. Designated content exceeds the stipulated capacity during ROM transmission. A read / write error occurred.
! 65	Protection error	A write operation of the program or system register was performed under the protection status (password setting) or with the master memory cassette installed.
! 66	Address error	There is an error in the code format of the address data. In addition, there is an error in the range assignment when it is exceeded or insufficient.
! 67	Missing program error/Missing data error	It is not possible to read due to the program area has no program or abnormal memory contents. Or you want to read an unregistered data.
! 68	Can not rewrite in RUN error	Edit instructions cannot be rewritten in RUN (ED, SUB, RET, INT, IRET, SSTP, STPE). Nothing has written into the control unit.
! 71	Exclusive control error	Execution of the instruction can not be processed simultaneously with the instructions in process.

26.9 Dimensions

26.9.1 Dimensions

■ FP-XH M8N16PD control unit

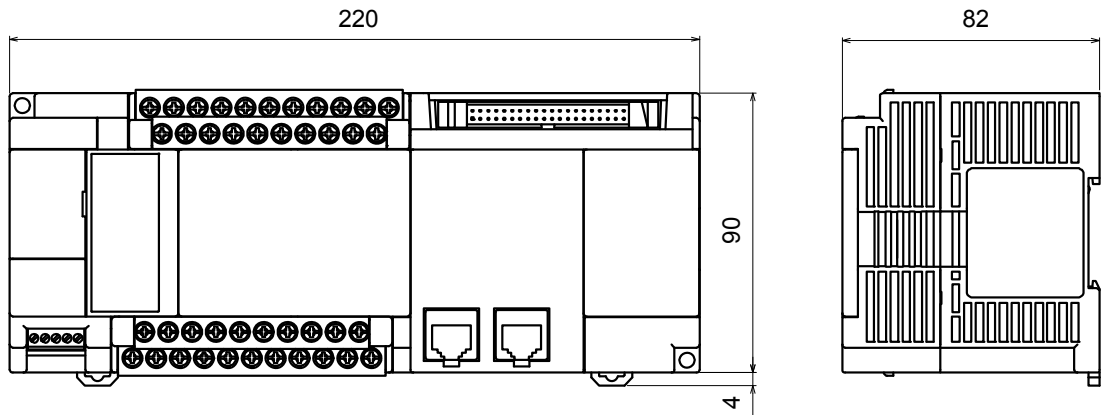

Unit: mm

26.9.2 Installation Dimensions

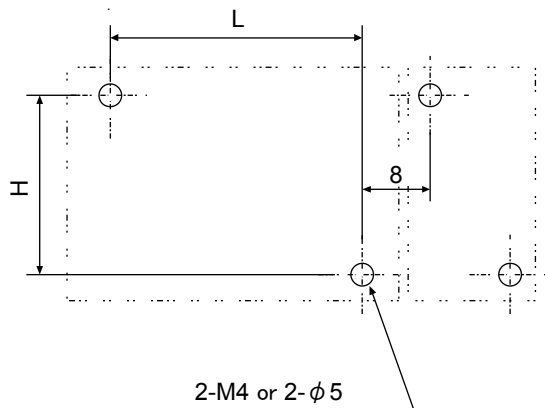

Model	L	H
M8N	212	82

Unit: mm

Record of changes

Manual No.	Date	Record of Changes
WUME-FPXHM8N16PD-01	Sep.2017	First Edition

Please contact

Panasonic Industrial Devices SUNX Suzhou Co., Ltd.

■ 97, Huoju Road, Suzhou New District, Jiangsu, China

■ Telephone: +86-512-6843-2580 ■ Facsimile: +86-512-6843-2590

panasonic.net/id/pidsx/global

For our sale network, please visit our website.